

# **SRF206/212/224 Smart Recorder Dot Printing Model "Installation/Operation" User's Manual**



**Thank you for purchasing the SRF206/212/224 Smart Recorder Dot Printing Model.**

**This manual contains information for ensuring the correct use of the SRF206/212/224. It also provides necessary information for installation, maintenance, and troubleshooting.**

**This manual should be read by those who design and maintain equipment that uses the SRF206/212/224. Be sure to keep this manual nearby for handy reference.**

**Yamatake Corporation**

---

---

## RESTRICTIONS ON USE

---

---

This product has been designed, developed and manufactured for general-purpose application in machinery and equipment.

Accordingly, when used in applications outlined below, special care should be taken to implement a fail-safe and/or redundant design concept as well as a periodic maintenance program.

- Safety devices for plant worker protection
- Start/stop control devices for transportation and material handling machines
- Aeronautical/aerospace machines
- Control devices for nuclear reactors

Never use this product in applications where human safety may be put at risk.

### NOTICE

---

Be sure that the user receives this manual before the product is used.

Copying or duplicating this user's manual in part or in whole is forbidden. The information and specifications in this manual are subject to change without notice.

Considerable effort has been made to ensure that this manual is free from inaccuracies and omissions. If you should find an error or omission, please contact Yamatake Corporation.

In no event is Yamatake Corporation liable to anyone for any indirect, special or consequential damages as a result of using this product.

---

---

©1998 Yamatake Corporation ALL RIGHTS RESERVED

The SRF™ is a trademark of Yamatake Corporation in Japan.

# SAFETY REQUIREMENT



To reduce risk of electrical shock which could cause personal injury, follow all safety notices in this documentation.



This symbol warns the user of a potential shock hazard where hazardous live voltages may be accessible.

- If the equipment is used in a manner not specified by the manufacturer, the protection provided by the equipment must be impaired.
- Do not replace any component (or part) not explicitly specified as replaceable by your supplier.
- All wiring must be in accordance with local norms and carried out by authorized experienced personnel.
- The protective terminal earth must be connected before any other wiring (and disconnected last).  
(Class I:IEC536)

## **EQUIPMENT RATINGS**

Supply voltages:	100 to 240Vac (allowable voltage: 90 to 250Vac)
Frequency:	50/60Hz
Power or current ratings:	100VA maximum
Fuse:	3A 250V, Time-lag (IEC127)
Sound pressure level:	80dB(A) maximum (at a position of 1 meter from the equipment)

## **EQUIPMENT CONDITIONS**

Do not operate the instrument in the presence of flammable liquids or vapors. Operation of any electrical instrument in such an environment constitutes a safety hazard.

Temperature:	0 to 50°C
Humidity:	30 to 90%RH
Vibration:	Frequency 0 to 100Hz Acceleration 0.98m/s <sup>2</sup> maximum
Over-voltage category:	CategoryII (IEC60364-4-443, IEC60664-1)
Pollution degree:	Pollution degree 2
Environmental condition:	Permanently connected equipment, Indoor use, Panel mounted equipment

## **EQUIPMENT INSTALLATION**

The recorder must be mounted into a panel to limit operator access to the rear terminals.

Specification of common mode voltage: The common mode voltages of all I/O except for main supply and relay outputs are less than 33Vrms, 46.7V peak and 70Vdc.

## **APPLICABLE STANDARDS**

EN61010-1, EN61326

### **! Handling Precautions**

When the carrying handle kit is installed, the recorder does not conform to the standard EN61010-1.

### **CAUTION**

Danger of explosion if battery is incorrectly replaced.

Replace only with the same or equivalent type recommended by the manufacturer.

Dispose of used batteries according to the manufacturer's instructions.

# SAFETY PRECAUTIONS

## ■ About Icons

The safety precautions described in this manual are indicated by various icons. Please be sure you read and understand the icons and their meanings described below before reading the rest of the manual.

Safety precautions are intended to ensure the safe and correct use of this product, to prevent injury to the operator and others, and to prevent damage to property. Be sure to observe these safety precautions.





Warnings are indicated when mishandling this product might result in death or serious injury.







Cautions are indicated when mishandling this product might result in minor injury to the user, or only physical damage to the product.









## ■ Examples

	Use caution when handling the product.
	The indicated action is prohibited.
	Be sure to follow the indicated instructions.

# **WARNING**

	<p>Before removing/mounting or wiring the SRF206/212/224, be sure to turn the power OFF. Touching electrically charged parts on the SRF206/212/224 such as terminals by mistake might cause electric shock.</p>
	<p>Before connecting the SRF206/212/224 to the measurement target or external control circuits, make sure that a protective ground terminal is connected to the SRF206/212/224. Failure to do so might cause electric shock or fire.</p>
	<p>The black-headed screw on the right of the main unit is for ground protection. Never remove this screw. Doing so might cause electric shock.</p>
	<p>To prevent danger before you replace the clock backup battery, turn the power OFF, and disconnect the SRF206/212/224 from its power supply.</p>

# **CAUTION**

	<p>Wire the SRF206/212/224 according to established standards. Also wire the SRF206/212/224 using designated power leads according to recognized installation methods. Failure to do might cause electric shock, fire or faulty operation.</p>
	<p>Use the SRF206/212/224 within the operating ranges recommended in the specifications (temperature, humidity, voltage, vibration, shock, atmosphere, etc.). Failure to do so might cause faulty operation.</p>
	<p>Do not block ventilation holes. Doing so might cause faulty operation.</p>
	<p>Do not disassemble the SRF206/212/224, nor touch components inside the SRF206/212/224. Doing so might cause electric shock or faulty operation.</p>
	<p>Load the chart and ink ribbon cassette either with the power OFF or with the recorder stopped (the RCD LED should be OFF). Do not push the cassette with excessive force. Doing so might force a movement of the ink ribbon cassette holder (see page 4-4), damaging the gear and causing faulty operation.</p>
	<p>Do not touch internal components during use or immediately after turning the power OFF. Doing so might cause burns.</p>
	<p>Do not touch moving parts during operation. Doing so might cause injury.</p>
	<p>Do not operate the keys with a mechanical pencil or other sharp-tipped object. Doing so might cause faulty operation.</p>

# Unpacking

## ■ Check the model No.

Check the model No. to make sure that you have received the product that you ordered. The model No. for this product is listed at two places: on the side of the case and on the inner left side of the chassis.

See ■ **Overall Schematic and Names of Parts** (page 2-1).

For details on whether this product supports optional functions and optional specifications, see **1-2 Model Selection Guide** (page 1-3).

## ■ Check the package for the following items

Name		Model No.	Q'ty	Remarks
Recorder			1	See <b>1-2 Model Selection Guide</b> , page 1-3.
Folding chart 100-sections		81407861-001	1	
Ink ribbon cassette		81407408-001	1	
Fuse		81446289-002	1	
Mounting bracket		81446291-002	1	
User's manual	Installation/operation	CP-SP-1027E	1	This manual
	SRF206/212/224 CPL communications	CP-SP-1028E	1	

## ■ A note about shipping

Transportation fastening screws are not used as the structure of this product is such that the chassis (inner part of the recorder) is fastened to the case by screws.

## ■ Do not remove the black-headed screw on the recorder

### **WARNING**



The black-headed screw on the right of the main unit is for ground protection. Never remove this screw. Doing so might cause electric shock.

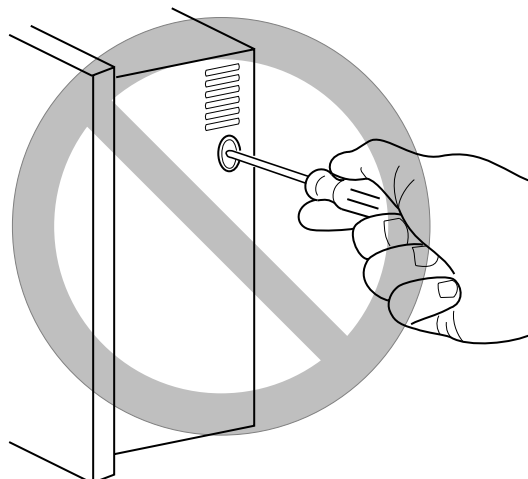

# The Role of This Manual

In all, three manuals have been prepared for the SRF206/212/224. Read the manual according to your specific requirements. This manual is the SRF206/212/224 User's Manual. The following lists all the manuals that accompany the SRF206/212/224 and gives a brief outline of the manual. If you do not have the required manual, contact Yamatake Corporation or your dealer.

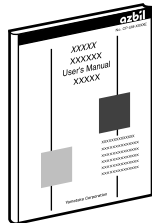

## **SRF206/212/224 Installation/Operation      Manual No. CP-SP-1027E**

This manual.

This manual is required reading for those who use the SRF206/212/224, those who design hardware for integrating the SRF206/212/224 into operator control panels, those who carry out maintenance, and those who operate instruments in which the SRF206/212/224 is integrated.

It describes how to install and wire the SRF206/212/224 for integrating into instruments, method of operation, maintenance and inspection, troubleshooting, and hardware specifications.

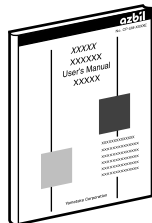

## **SRF206/212/224 DigitroniK CPL Communications**

**Manual No. CP-SP-1028E**

The SRF206/212/224 can communicate with other equipment via the RS-485 or RS-232C interfaces.

This manual describes communications procedures and commands when the SRF206/212/224's communications features are used.

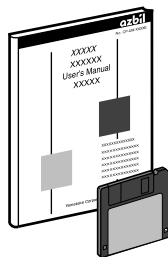

## **SLP-F10/F20 Smart Loader Package**

**Manual No. CP-UM-5067E**

This manual is packaged with the SLP-F10/F20.

Running the SLP-F10/F20 package on a personal computer enables you to set up SRF100/200 parameters on the personal computer.

This manual describes operations on the personal computer.

This manual is the common manual of the SLP-F10 and the SLP-F20.

# Organization of This User's Manual

---

This manual is organized as follows:

## **Chapter 1. INTRODUCTION**

This chapter describes SRF206/212/224 applications and features, and gives a list of catalog numbers.

## **Chapter 2. NAMES AND FUNCTIONS OF PARTS**

This chapter describes the names and functions of parts of the SRF206/212/224.

## **Chapter 3. INSTALLATION AND WIRING**

This chapter describes precautions, siting conditions and installation method when installing the SRF206/212/224 into devices, and how to connect to peripheral equipment.

## **Chapter 4. PREPARATION AND OPERATION**

This chapter describes checks to carry out before operating the SRF206/212/224 and daily operation procedure.

## **Chapter 5. BASIC CONFIGURATION**

This chapter describes the basic setup details of the SRF206/212/224.

## **Chapter 6. DETAILED CONFIGURATION**

This chapter describes all items that can be set using the operation keys.

## **Chapter 7. MAINTENANCE**

This chapter describes inspection items and how to replace maintenance parts to ensure prolonged use of the SRF206/212/224.

## **Chapter 8. TROUBLESHOOTING**

This chapter describes points to check when the SRF206/212/224 is not working properly and how to remedy trouble that might occur.

## **Chapter 9. SPECIFICATIONS**

This chapter describes the general specifications, performance specifications and external dimensions of the SRF206/212/224.

## **APPENDICES**



# Contents

---

<b>SAFETY REQUIREMENT</b>	
<b>SAFETY PRECAUTIONS</b>	
Unpacking	
The Role of This Manual	
Organization of This User's Manual	
Conventions Used in This Manual	

## Chapter 1. INTRODUCTION

1-1 Applications and Features .....	1-1
■ Features .....	1-1
■ Optional Functions .....	1-2
1-2 Model Selection Guide .....	1-3
■ Model Listing .....	1-3
■ Related Parts Model Listing .....	1-3

## Chapter 2. NAMES AND FUNCTIONS OF PARTS

2-1 Main Unit .....	2-1
■ Overall Schematic and Names of Parts .....	2-1
■ Terminals on Rear Side .....	2-2
2-2 Display Setup Unit .....	2-3
■ Operation Display and Operation Keys .....	2-3
■ Configuration Unit and Operation Keys .....	2-4

## Chapter 3. INSTALLATION AND WIRING

3-1 Installation Site .....	3-1
■ Siting Conditions .....	3-1
3-2 Installation .....	3-2
■ Installation Dimensions .....	3-2
■ Installation Procedure .....	3-2
3-3 Wiring Precautions .....	3-3
■ Description of Symbols on Terminal Layout Label .....	3-3
■ Noise Countermeasures .....	3-4
■ Recommended Crimped Terminal .....	3-4
3-4 Connecting the Power Supply and Ground .....	3-5
3-5 I/O Signal Leads .....	3-6
■ Wiring Analog Inputs .....	3-7
■ Wiring Relay Outputs (optional function) .....	3-8
■ Wiring Open Collector Outputs (optional function) .....	3-9
■ Wiring External Switch Inputs (optional function) .....	3-11
■ Connecting the RS-485 Interface (optional function) .....	3-12
■ Connecting the RS-232C Interface (optional function) .....	3-13

---

## Chapter 4. PREPARATION AND OPERATION

4-1	Preparation (loading the chart and ink ribbon cassette) .....	4-1
■	Loading the Chart .....	4-1
■	Loading the Ink Ribbon Cassette .....	4-4
4-2	Operation .....	4-6
■	Turning the Power ON .....	4-6
■	Starting/stopping Recording .....	4-6
■	Feeding the Chart .....	4-7
■	Selecting the Display Mode .....	4-7
■	Recording a Specific Table .....	4-8
■	Other Displays and Operations .....	4-9
■	Printout Details .....	4-9
■	Replacing the Chart .....	4-12
■	Replacing the Ink Ribbon Cassette .....	4-13

## Chapter 5. BASIC CONFIGURATION

5-1	Introduction .....	5-1
5-2	Basic Key Operations at Setup, Configuration Lock and Menu Levels .....	5-2
■	Basic Key Operations at Setup .....	5-2
■	Canceling Configuration Lock .....	5-4
■	Changing the Menu Level .....	5-5
5-3	Changing Event Setting Values .....	5-6
■	Starting Setup .....	5-6
■	Selecting the Target Channel No. ....	5-6
■	Selecting the Target Event No. ....	5-7
■	Enabling Changing of Event Setting Values .....	5-7
■	Entering Event Setting Values .....	5-7
5-4	Changing the Date/Time .....	5-8
■	Starting Setup .....	5-8
■	Changing the Date .....	5-8
■	Changing the Time .....	5-8
5-5	Printing Lists .....	5-9
■	Stopping Recording .....	5-9
■	Starting Setup .....	5-9
■	Selecting the List to be Printed .....	5-10
■	Stopping List Printing Midway .....	5-10
■	Print Communications List .....	5-10
■	Print Specified Lists .....	5-11
■	Print All Lists .....	5-13

---

## Chapter 6. DETAILED CONFIGURATION

6-1	Introduction .....	6-1
6-2	Configuration Data and Factory Settings .....	6-2
	■ Event Setup (individual channels): EVNT .....	6-2
	■ Chart Feed Speed Setup: SPD.....	6-2
	■ Date/Time Setup: CLK.....	6-2
	■ System Setup: SYS.....	6-3
	■ Range Setup (individual channels): RNG.....	6-4
	■ Calculation Setup (individual channels): RNG .....	6-4
	■ Scale Setup (individual channels): SCL .....	6-5
	■ Copy Function: COPY .....	6-5
	■ Schedule Demand: SYS + S d. ....	6-5
	■ Message Setup: SYS + m.S. ....	6-6
	■ User Function Key Setup: SYS + U 1/U 2. ....	6-7
	■ Extended Setup: SYS + E t. ....	6-8
	■ External Switch Input Setup: ST + E S.1	
	Internal Contact Input Setup: ST + I S. ....	6-9
	■ Relay Output Setup: SYS + r o.1	
	Open Collector Output Setup: SYS + d o. ....	6-9
	■ Segment Table 1 Setup: SYS + t A., t b. ....	6-10
	■ Segment Table 2 Setup: SYS + t C., t d. ....	6-10
	■ Segment Table 3 Setup: SYS + t E., t F. ....	6-10
6-3	Event Setup .....	6-11
	■ Event Setup .....	6-11
	■ Description of Event Setup Items .....	6-12
6-4	Chart Feed Speed Setup .....	6-13
	■ Chart Feed Speed Setup .....	6-13
	■ Description of Chart Feed Speed Setup Items.....	6-14
6-5	Date/Time Setup.....	6-15
	■ Date/Time Setup.....	6-15
6-6	System Setup .....	6-16
	■ System Setup .....	6-16
	■ Description of System Setup Items .....	6-18
6-7	Range Setup.....	6-19
	■ Range Setup.....	6-19
	■ How to Set the Engineering Unit.....	6-20
	■ Description of Range Setup Items .....	6-20
6-8	Calculation Setup.....	6-23
	■ Calculation Setup .....	6-23
	■ Description of Calculation Setups .....	6-24
6-9	Scale Setup .....	6-26
	■ Scale Setup .....	6-26
	■ Description of Scale Setup Items.....	6-27
6-10	Copy Function.....	6-29
	■ Copy Function.....	6-29
6-11	Schedule Demand Setup.....	6-30
	■ Schedule Demand Setup.....	6-30
	■ Description of Schedule Demand Setup .....	6-31

---

6-12 Message Setup.....	6-32
■ Message Setup.....	6-32
6-13 User Function Key Setup .....	6-33
■ Setting Configuration Lock.....	6-33
■ Description of User Function Key Setup.....	6-34
6-14 Extended Setup.....	6-35
■ Extended Setup.....	6-35
■ Description of Extended Setup .....	6-35
6-15 External Switch Input/Internal Contact Input Setup .....	6-37
■ External Switch Input Setup .....	6-37
■ Internal Contact Input Setup.....	6-37
■ Description of External Switch Input/Internal Contact Input Setup.....	6-39
6-16 Relay Output Setup.....	6-40
■ Relay Output Setup .....	6-40
■ Description of Relay Output Setup .....	6-41
6-17 Open Collector Output Setup .....	6-43
■ Open Collector Output Setup .....	6-43
6-18 Segment Table Setup .....	6-44
■ Segment Table Setup .....	6-44
6-19 Range Code Table.....	6-47
6-20 Character Code Table.....	6-49
6-21 About Digital Printing Priority .....	6-50
■ Printing Control During a Print Conflict .....	6-50
■ Simultaneous Printing Control .....	6-50
6-22 Calculation Functions .....	6-51
■ Broken-line approximation .....	6-52
■ Input Calculation.....	6-53
6-23 Operation of External Switch Input/Internal Contact Input Functions.....	6-56

## Chapter 7. MAINTENANCE

7-1 Periodic Inspection.....	7-1
7-2 Replacing the Clock Backup Battery .....	7-3
7-3 Replacing the Fuse.....	7-5
7-4 Measuring the Display Accuracy of Analog Inputs .....	7-6
■ Equipment Required for Measurement.....	7-6
■ Measurement Environment.....	7-6
■ Procedure .....	7-6
7-5 Adjusting the Dot Position.....	7-8
■ About Recording Accuracy .....	7-8
■ About Standard Conditions .....	7-8
■ Procedure .....	7-9

## Chapter 8. TROUBLESHOOTING

8-1 Alarm Display and Descriptions.....	8-1
8-2 Remediating Trouble .....	8-4

## Chapter 9. SPECIFICATIONS

---

## Chapter 9. SPECIFICATIONS

9-1 Specifications .....	9-1
■ General Specifications .....	9-1
■ Performance Specifications .....	9-2
9-2 Input Types, Ranges and Display Accuracy .....	9-7
9-3 External Dimensions .....	9-9

## APPENDICES

### Customer Setup Sheets

■ Contents .....	App.-1
■ How to Use the User Setup Sheets .....	App.-1

---

## Conventions Used in This Manual

---

The following conventions are used in this manual:



### Handling Precautions

: Handling Precautions indicate items that the user should pay attention to when handling the SRF206/212/224.



### Note

: Notes indicate useful information that the user might benefit by knowing.

*AL03*

: These indicate 7-segment indications on the data display.



key



key

: These icons represent keys on the SRF206/212/224.

(1)(2)(3)

: The numbers with the parenthesis indicate steps in a sequence or indicate corresponding parts in an explanation.



# Chapter 1. INTRODUCTION

## 1 - 1 Applications and Features

---

This multi-input, 6/12/24 dot printing, high-function recorder accommodates a 180mm wide chart. This recorder offers the dual features of advanced functions and operating ease as a recorder for various equipment and instrumentation.

It also supports relay output, open collector output, external switch inputs, chart illumination lamp and communications, as optional functions.

### ■ Features

- Any combination of inputs and recording scales can be freely set.  
DC voltage, thermocouple, resistance temperature detector (RTD), communications, ON/OFF input
- Five recording formats are provided and can be freely selected:
  - Trend recording
  - Trend + tabulation recording
  - Trend + schedule demand recording
  - Fixed interval tabulation
  - Fixed time tabulation
- Six measurement and calculation methods are provided and can be selected to each channel:
  - Measurement value (PV value)
  - Deviation value between channels
  - Deviation value from fixed value
  - Total calculation
  - F value calculation
  - Temperature/humidity calculation
- Universed power supply allows use anywhere:  
100 to 240Vdc, 50/60Hz
- Wide range of printing functions:
  - Measurement value (PV value)
  - Channel No.
  - Tag (12 characters per channel)
  - Engineering unit (6 characters per channel)
  - Recording scale (2 types, upper/lower limit values)
  - Chart feed speed
  - Event status (details, time of occurrence/restoration)
  - Time marker
  - Date
  - Time (h:min)
- Printing at the following start conditions is possible:
  - Date
  - Time (h:min)
  - Recording format
  - Chart feed speed
  - Recorder ID No.
- Demand printing also is possible.  
Printing is started by the  key or external switch input (option), and time (h:min) and measurement values (PV value) are printed.

- When trend + schedule demand recording is selected as the recording format, the measurement value (PV value) of up to eight preset times can automatically be printed.
- Up to 24 digital inputs are supported: 12 external switch inputs coupled to remote switches, and 12 internal contact inputs that are connected to internal signals.  
Output signals for up to 96 events (4 types x 24 channels) can be connected to any 12 internal contact inputs.
- Parameter setups can be assigned to user function keys, (up to eight types for each of the two switches).
- Printing of “Date/Time (h:min)”, “Scale” and “event” can be disabled.
- Seven list printing modes are available for printing setup data: print specified list, print function lists (four modes), print all lists and print user lists.
- Upscale, downscale or OFF can be set as the thermocouple burnout setting for each input channel.
- Setup data is protected in EEPROM when the power is OFF.
- Copy setting  
Various setup data can be copied between channels.
- Segment table setup  
Output values (Y-axis) for input values (X-axis) can be offset by setting up segment tables.
- Print user setup lists  
Any list (85 characters x 3 lines) can be printed from a loader or by CPL communications.

## ■ Optional Functions

The following optional functions are available:

- Relay outputs (6/12 outputs; SPDT relay output)
- External switch inputs (4/8/12; Recording ON/OFF, Demand printing, Chart feed, Print messages No.1 to No.8, Chart feed speed/Scale selection, etc.)
- Open collector outputs (12 outputs)
- Chart illumination lamp (cold cathode fluorescent light)
- Communications (RS-485, RS-232C)



# 1 - 2 Model Selection Guide

## Model Listing

Basic model No.	Power	Input	Option 1	Option 2	Option 3	Addition 1	Addition 2	Specifications
SRF206								180mm 6-dot recorder
SRF212								180mm 12-dot recorder
SRF224								180mm 24-dot recorder
	A							100 to 240Vac, 50/60Hz
		S						Full multi-input (standard specification)
			0					None
			1					Relay outputs (6)
			2					Relay outputs (6) + external switch inputs (4)
			4					Relay outputs (12)
			5					Relay outputs (12) + external switch inputs (8)
			7					Relay outputs (12) + open collector outputs (12)
			8					Relay outputs (12) + open collector outputs (12) + external switch inputs (12)
				0				Communications not supported
				1				RS-485
				2				RS-232C
					0			None
					1			Chart illumination lamp provided
						0		None
						D		Inspection certificate provided
						T		Tropical treatment
						B		Tropical treatment + Inspection certificate provided
							0	None

## Related Parts Model Listing

### Consumables

Name	Model No.	Application Range (example)	Remarks
Folding chart 100-sections	81407861-001	0, 20, 40, 60, 80, 100	10 packets, 20m
Folding chart (Recycled paper) 100-sections	81409978-001	0, 10, 20, 30, 40, 50 0, 20, 40, 60, 80, 100 0, 40, 80, 120, 160, 200	10 packets, 20m
Folding chart (Recycled paper) 120-sections	81409978-002	0, 10, 20, 30, 40, 50, 60 0, 200, 400, 600, 800, 1000, 1200	10 packets, 20m
Folding chart (Recycled paper) 140-sections	81409978-003	0, 2, 4, 6, 8, 10, 12, 14 0, 10, 20, 30, 40, 50, 60, 70	10 packets, 20m
Folding chart (Recycled paper) 80-sections	81409978-004	0, 20, 40, 60, 80 0, 100, 200, 300, 400 0, 400, 800, 1200, 1600	10 packets, 20m
Folding chart (Recycled paper) 150-sections	81409978-005	0, 50, 100, 150	10 packets, 20m
Clean paper chart 100-sections	81407937-001	0, 20, 40, 60, 80, 100	10 packets, 16m
Ink ribbon cassette	81407408-001	—	1 cassette

● **Optional parts**

Name	Model No.	Remarks
250Ω resistor (accuracy ±0.02%)	81401325	1 p'ce
250Ω resistor (accuracy ±0.05%)	81446642-001	2 p'ces
Cross cable for RS-232C interface	CBL232FNZ02	1 p'ce , 2m
Carrying handle kit	81446643-001	With power cable supplied
Add-on optional unit	81446645-001	6 relays
Add-on optional unit	81446645-002	6 relays + RSW (4)
Add-on optional unit	81446645-003	6 relays + RSW (4) + RS-232C
Add-on optional unit	81446645-004	6 relays + RSW (4) + RS-485
Add-on optional unit	81446645-007	RS-232C
Add-on optional unit	81446645-011	12 open collectors + RSW (4)

RSW: External switch input

● **Maintenance parts**

Name	Model No.	Remarks
Standard tag plate	81446612-001	10 p'ces
Fuse	81446289-002	10 p'ces
Mounting bracket	81446291-002	1 set (2 brackets)
Replacement door	81446608-001	With pin and spring
Chart cassette	81446609-001	Unit ass'y component
Chart holder	81446610-001	Plastic formed component
Chart guide	81446611-001	Plastic formed component (transparent)
Chart holding sheet	81446613-001	5 p'ces
Option terminal cover	81446427-002	
Analog input terminal cover	81446428-002	
Power terminal cover	81446429-001	
M3.5 free terminal screw	81446441-002	10 p'ces
Power cable	81446475-001	

● **Smart Loader Package SLP**

Name	Model No.	Remarks
Smart Loader Package	SLP-F20	

# Chapter 2. NAMES AND FUNCTIONS OF PARTS

## 2 - 1 Main Unit

### Overall Schematic and Names of Parts

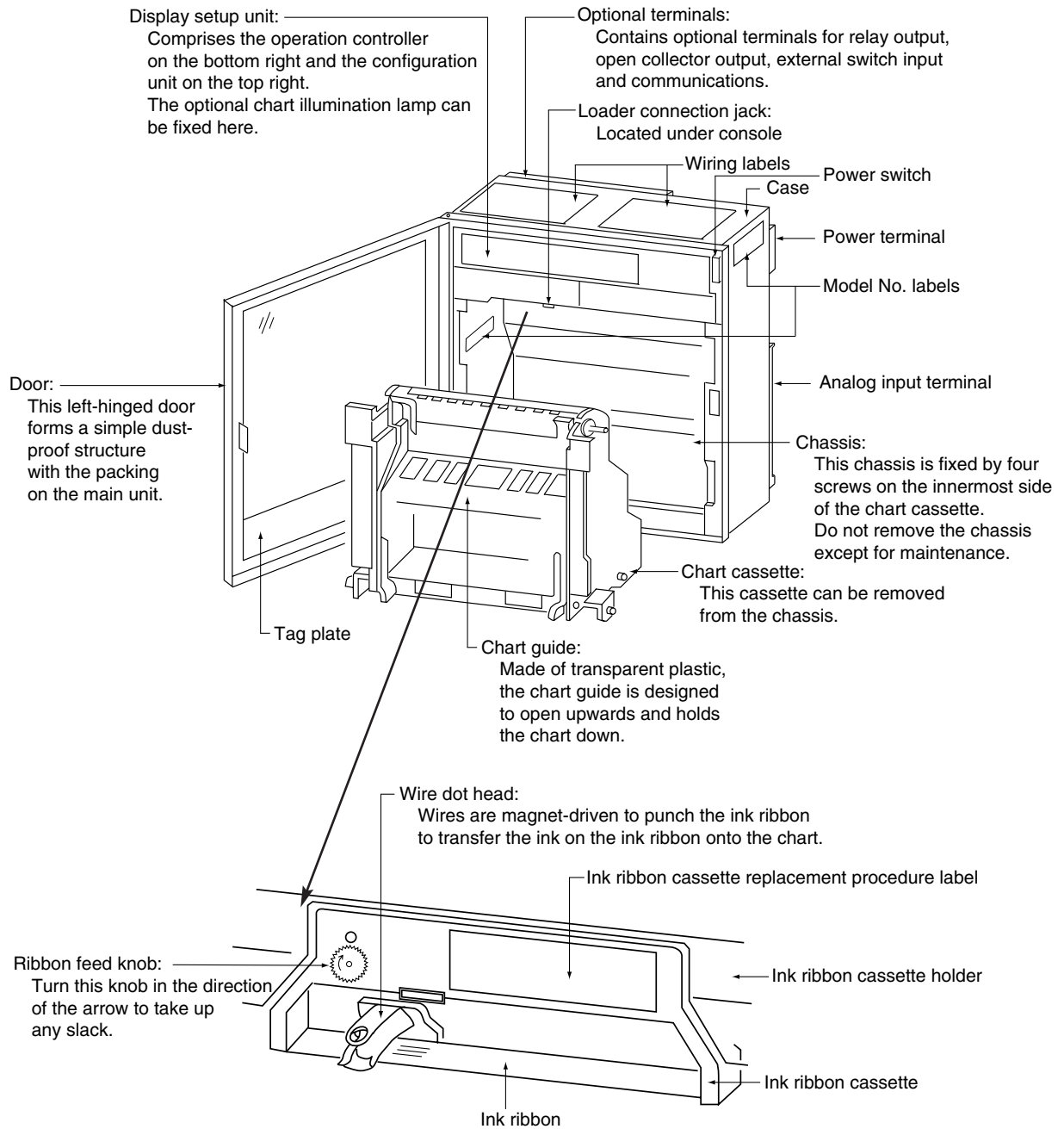

■ Terminals on Rear Side

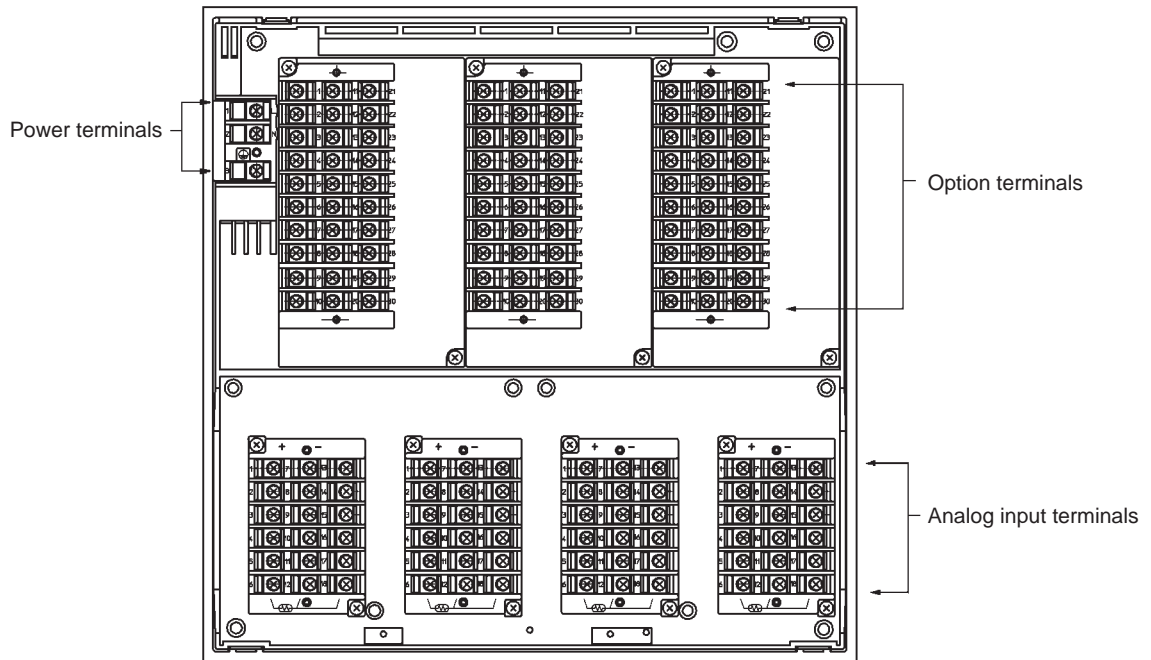

For details on signals connected to terminals, see **Chapter 3. INSTALLATION & WIRING.**

## 2 - 2 Display Setup Unit

### ■ Operation Display and Operation Keys

The following describes the operation panel on the display setup unit:

#### ● Operation keys

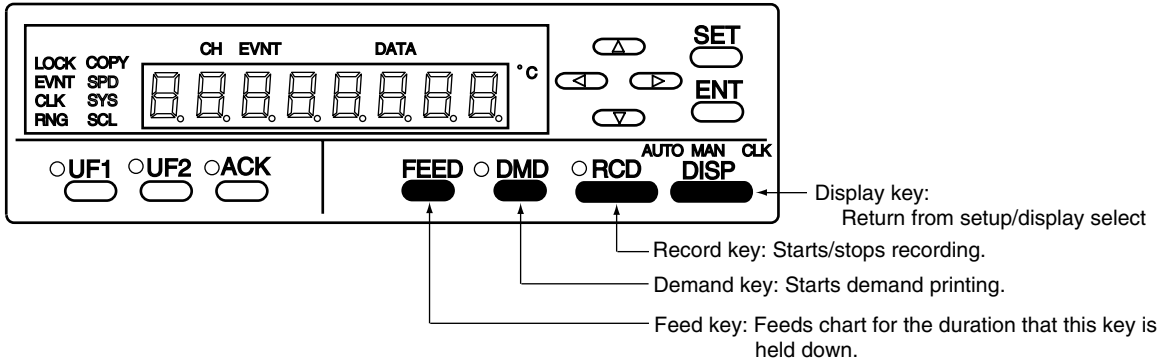

#### ● Operation display

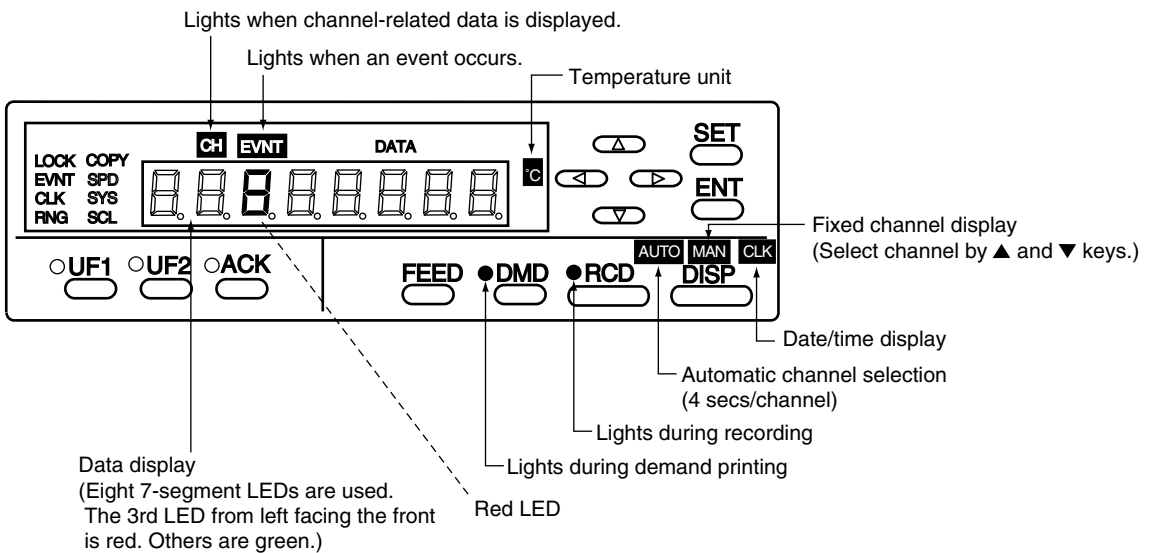

#### Display examples

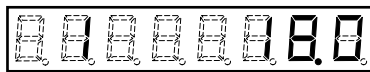

AUTO or MAN indicates PV input value.  
The example on the left shows a value of 18.0 for channel 1.



CLK indicates the date.  
The example on the left shows the date June (06) 24th (24) 1997 (97).



CLK indicates the time.  
The example on the left shows the time 13:28.

## ■ Configuration Unit and Operation Keys

The following describes the configuration unit on the display setup unit:

### ● Setup keys

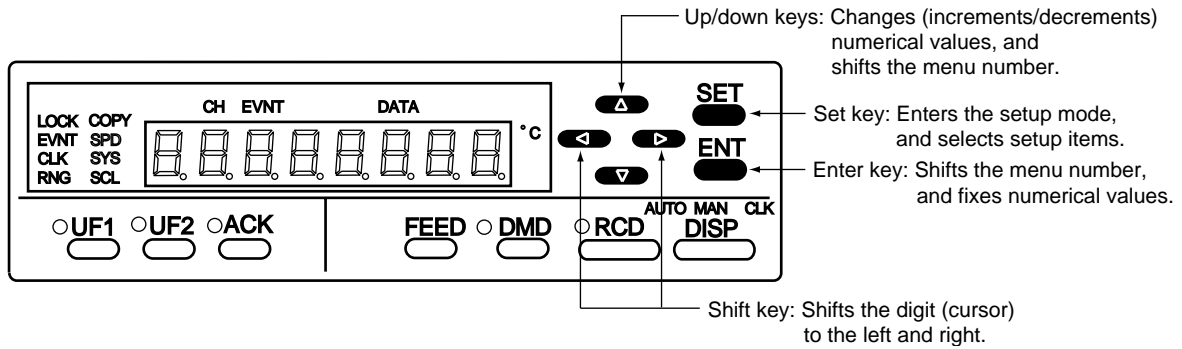

### ● Setup display

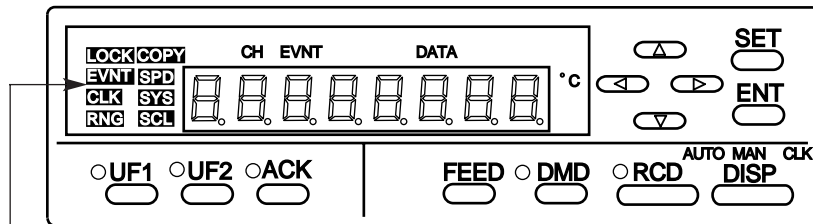

- LOCK : The configuration is locked. (When lit, setups can be confirmed but not changed. Setups can be changed by the user configuration keys.)
- EVNT : Event setting is being set up. (Event type and differentials can also be set according to the system setup level.)
- SPD : Chart feed speed is being set up. (Sets the chart feed speed.)
- CLK : Date and time (h:min) are being set up.
- SYS : The system is being set up. (Menu levels for locking configuration, printing lists and entering more detailed menus can be set.)
- RNG : The input range is being set up. (The recording mode, input type, measurement range and PV bias can be set according to the menu level.)
- SCL : Scale is being set up. (The recording scale can be set according to the menu level.)
- COPY : Copy is being set up. (Setups can be copied to other channels.)

### Display examples



Checking or setting configuration lock:  
In the example on the left, the configuration lock setting is 1.



Checking or setting events:  
In the example on the left, the setting of event setup 1 on channel 1 is 50.0.



Checking or setting the chart feed speed:  
In the example on the left, the chart feed speed 1 setting is 40mm/h.

● Operation keys

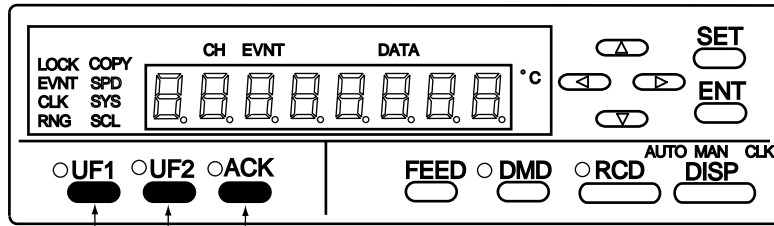

Hold output cancel key:  
Cancels enabling of relay output and open collector output hold.

User function keys:  
Calls up preset setup items.  
Can also be used for internal contact inputs.





# Chapter 3. INSTALLATION AND WIRING

## 3 - 1 Installation Site

### ■ Siting Conditions

The SRF206/212/224 is for indoor installation only. Install the SRF206/212/224 at a location that satisfies the following conditions:

- (1) Close to room temperature, not subject to large changes in temperature
- (2) Not exposed to corrosive gas
- (3) Humidity is neither excessively low or high
- (4) Not subject to excessive mechanical vibration
- (5) Not subject to excessive dust or oil smoke
- (6) Not subject to excessive electrical noise
- (7) Not subject to magnetic fields

### ! Handling Precautions

- Keep the mounting angle to within 0 to 30° from the bottom rear (bottom rear angle) or to within 0 to 3° from the top rear (top rear angle).
- Use a panel of at least 2mm in thickness for mounting the SRF206/212/224.

#### ● Mounting with back angled down

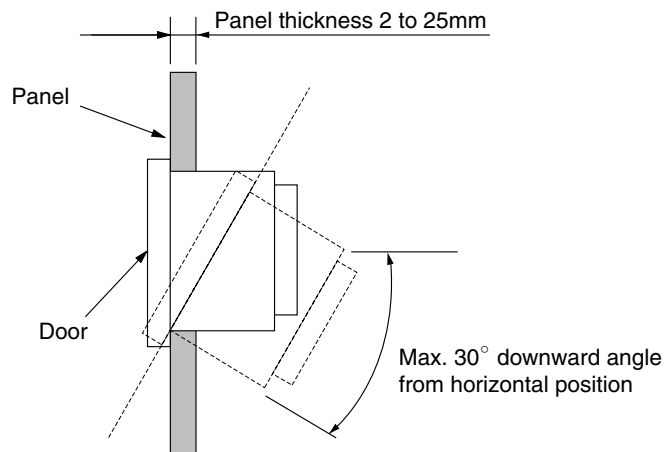

#### ● Mounting with back angled up

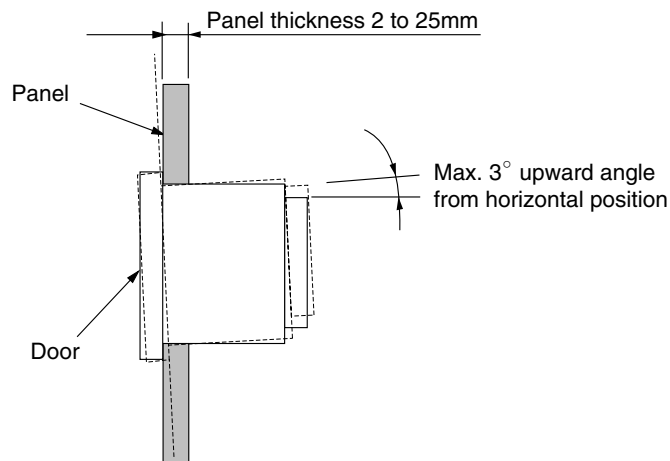

## 3 - 2 Installation

### ■ Installation Dimensions

The panel cutout dimensions are as follows:

(Unit: mm)

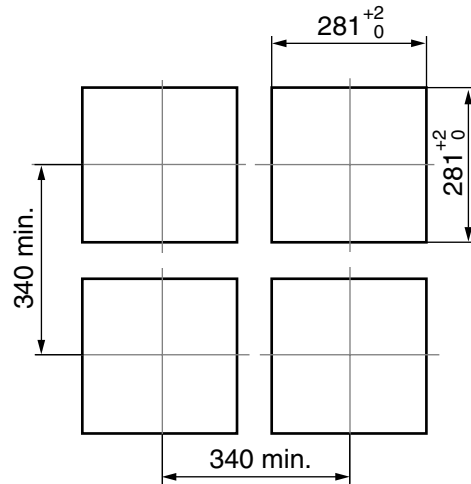

### ■ Installation Procedure

Use one of the mounting holes at the top, bottom, left or right of the case when mounting the SRF206/212/224.

- (1) Remove the seal covering the mounting hole to be used.
- (2) Insert the main unit case from the panel front.
- (3) Install the SRF206/212/224 onto the panel using the mounting brackets (provided).

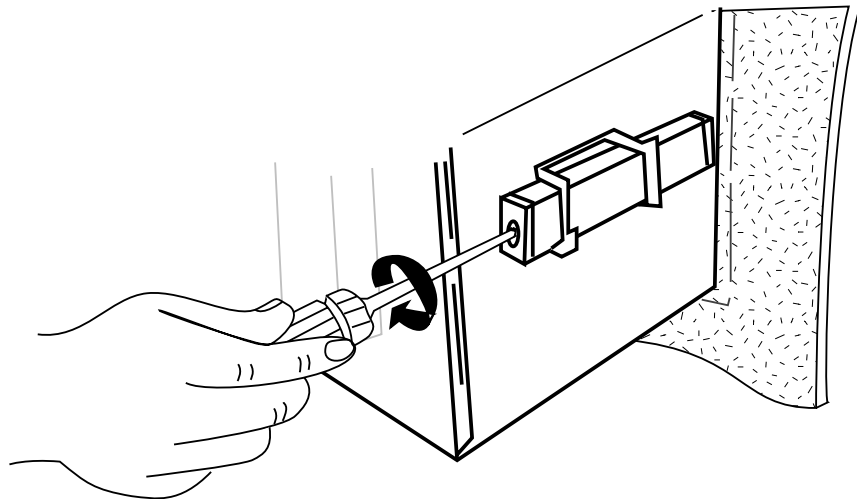







### ! Handling Precautions







- Remove the seal from only the mounting hole to be used when installing the SRF206/212/224. Do not remove the seals from the other mounting holes where the mounting bracket is not to be installed. These seals prevent dust from entering the case.
- The recommended tightening torque for the mounting bracket is 1.0 to 1.5N•m. Tightening the mounting bracket with a torque higher than this might deform the case or damage the mounting bracket.

## 3 - 3 Wiring Precautions

### WARNING





-  Before wiring the SRF206/212/224, be sure to turn the power OFF. Failure to do so might cause electric shock depending on the power voltage.
-  Before connecting the SRF206/212/224 to the measurement target or external control circuits, make sure that a protective ground terminal is connected to the SRF206/212/224. Failure to do so might cause electric shock or fire.
-  Before wiring the SRF206/212/224, also turn the power supply for the event leads OFF. Power is sometimes supplied to the event leads even if the SRF206/212/224 power is OFF, which might cause electric shock depending on the power voltage.
-  After wiring the leads to terminals, do not allow lead clippings to fall into mounting bracket holes or ventilation holes. Failure to do so might cause internal circuits to short-circuit or cause a fire.
-  Before wiring the SRF206/212/224, check the model numbers of instruments (including options) and terminal numbers on the affixed labels. When you have finished wiring, check the numbers again. Wiring the wrong lead to the wrong terminal might damage the main unit or cause a fire.
-  Be sure to attach the terminal cover after wiring the SRF206/212/224. Failure to do so might cause electrical shock. If you lose the terminal cover, attach an equivalent countermeasure or obtain a maintenance part.

### CAUTION

-  Do not connect loads that exceed the maximum load current. Doing so might damage the recorder.
-  Do not short-circuit loads. Doing so might damage the recorder.
-  Do not use unused terminals on the SRF206/212/224 as relay terminals.
-  Use crimped solderless terminals that fit on M3.5 or M4 screws.
-  Adopt sufficient noise countermeasures to prevent malfunction caused by electrical noise.
-  Maintain a distance of at least 50cm between input signal leads and power leads of 100V or more. Also, do not pass these leads through the same piping or wiring duct.
-  Devices and systems to be connected to this unit must have the basic insulation sufficient to withstand the maximum operating voltage levels of the power supply and input/output parts.

#### ■ Description of Symbols on Terminal Layout Label

The following table describes the meaning of symbols indicated on the terminal layout label on the SRF206/212/224:

Symbol	Meaning
	Alternating current (AC)
	Protective ground
	Danger of electric shock
	Caution

### ■ Noise Countermeasures

Digital equipment is easily influenced by electrical noise. Conditions that are not a problem on analog equipment might cause digital equipment to become damaged or malfunction.

When wiring, pay sufficient attention to the following items to prevent the influence of electrical noise:

**⚠ CAUTION**



Maintain a distance of at least 50cm between input signal leads and power leads of 100V or more. Also, do not pass these leads through the same piping or wiring duct.

#### ● Noise generating sources

Generally, the following generate electrical noise:

- (1) Relays and contacts
- (2) Solenoid coils, solenoid valves
- (3) Power lines (in particular, 100Vac min.)
- (4) Induction loads
- (5) Motor commutators
- (6) Inverters
- (7) Phase angle control SCR
- (8) Wireless communications equipment
- (9) Welding equipment
- (10) High-voltage ignition equipment

#### ● Noise reducing countermeasures

If the influence of electrical noise cannot be eliminated, we recommend taking the following countermeasures:

- Provision of a CR filter for fast-rising noise  
Recommended CR filter: Yamatake Corporation Model No. 81446365-001
- Provision of a varister for noise with a high wave height  
Recommended varister:

Yamatake Corporation Model No. 81446366-001 (100V)  
81446367-001 (200V)

However, note that the varister may become short-circuited when trouble occurs. Pay attention to this when providing a varister on the SRF206/212/224.

### ■ Recommended Crimped Terminal

Use crimped solderless terminals that conform to the following dimensions:

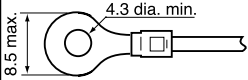
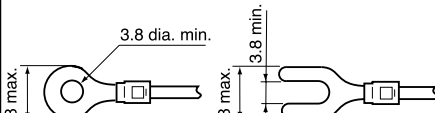
Terminal Name	Screw Dia.	Applicable Crimped Terminal (unit: mm)
Power terminals • Ground terminal	M4	 <p>4.3 dia. min. 8.5 max.</p>
Input terminal Relay output terminals (optional function) External switch input terminals (optional function) Communications terminal (optional function)	M3.5	 <p>3.8 dia. min. 8 max. 3.8 min.</p>

#### ⚠ Handling Precautions

- The recommended tightening torque for used terminal screws is 1N•m and 0.4N•m for unused terminal screws. Tightening terminal screws using a torque higher than this might damage the terminal screws.
- When wiring with crimped solderless terminals, take care to prevent contact with adjacent terminals.

## 3 - 4 Connecting the Power Supply and Ground

- Use 600V vinyl-insulated power lead (JIS C 3307) as the power supply lead.
- Obtain the SRF206/212/224 power supply from a single-phase instrumentation power supply not subject to excess noise.
- If the power supply generates excessive noise, add an insulating transformer, and use a line filter.

Recommended line filter: Yamatake Corporation 81446364-001.

- Keep the wiring from the line filter as short as possible. Bundling this wiring together is effective against electrical noise.
- After providing anti-noise countermeasures, do not bundle primary and secondary power leads together, or pass them through the same piping or wiring duct.

Connect the SRF206/212/224 by one-point grounding to the protective ground terminal. Do not perform any jump wiring. When it is difficult to ground shielded cables, prepare a separate ground terminal (earth bar).

- Grounding type: Lower than  $100\Omega$
- Grounding conductor: Annealed copper wire more than  $2\text{mm}^2$  (AWG14) or equivalent or thicker wire
- Grounding conductor length: Max. 20m

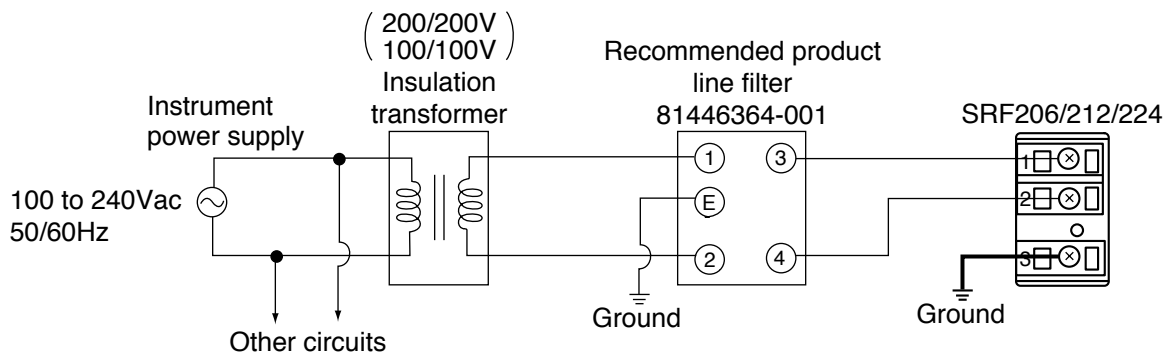

### ⚠ Handling Precautions

Take rush current into consideration when installing a power switch or use outside the SRF206/212/224.

## 3 - 5 I/O Signal Leads

---

(1) Thermocouple input signal lead

In the case of thermocouple input, connect the bare thermocouple lead to the terminal. If the thermocouple is located a long way from the SRF206/212/224, or the thermocouple is connected to a terminal, extend the connection using a compensating lead and then connect to the terminal. Use shielded compensating leads only.

(2) Resistance temperature detector (RTD)

- Use the three conductors.
- For the conductor, use JKEV-SB (JCS4364) shielded instrument cable or equivalent product. (This is commonly called as “twisted shielded cable for instruments.”)
- The wiring resistance is 10 $\Omega$  or less per conductor.
- Balance the resistances of the three conductors so that they are the same values.

(3) Analog inputs other than thermocouple and resistance temperature detector (RTD) and digital I/O leads

- Use twisted shielded cable for instruments.
- Shielded, multi-core microphone cord (MVVS) can be used if there is little electromagnetic induction.



**Note**

- Use no-voltage contact inputs, and assign these contacts for minute currents. (input no-load voltage: approx. 5V, input short-circuit current: approx. 6mA)
- Hold contact signals for 0.5s or more.



**Handling Precautions**

Be careful not to short-circuit across communications terminals SDA and SDB, or across RDA and RDB. Otherwise, this might damage the communications path.

■ Wiring Analog Inputs

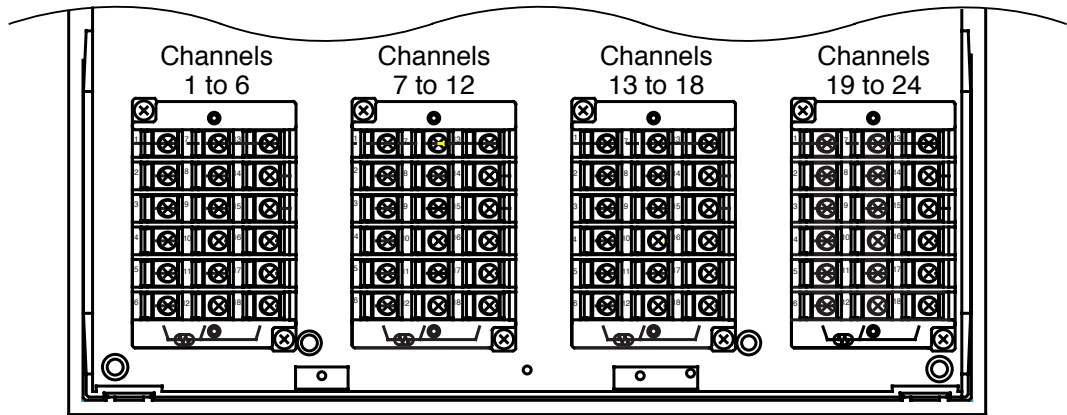

Channel No.	Channel No.	Channel No.	Channel No.
Channel 1	Channel 7	Channel 13	Channel 19
Channel 2	Channel 8	Channel 14	Channel 20
Channel 3	Channel 9	Channel 15	Channel 21
Channel 4	Channel 10	Channel 16	Channel 22
Channel 5	Channel 11	Channel 17	Channel 23
Channel 6	Channel 12	Channel 18	Channel 24

Connection	DC voltage	Resistance temperature detector
	Thermocouple	DC current input

\* Attach a current-voltage converting fixed resistor to the terminal plate.

\* A 250Ω precision resistor is available as an option.  
 (model No.: 81401325 or 81446642-001)  
 For details, see “Optional parts” on page 1-4.)

Note

Each of the channels are mutually isolated. (excluding terminal C for the resistance temperature detector)

■ Wiring Relay Outputs (optional function)

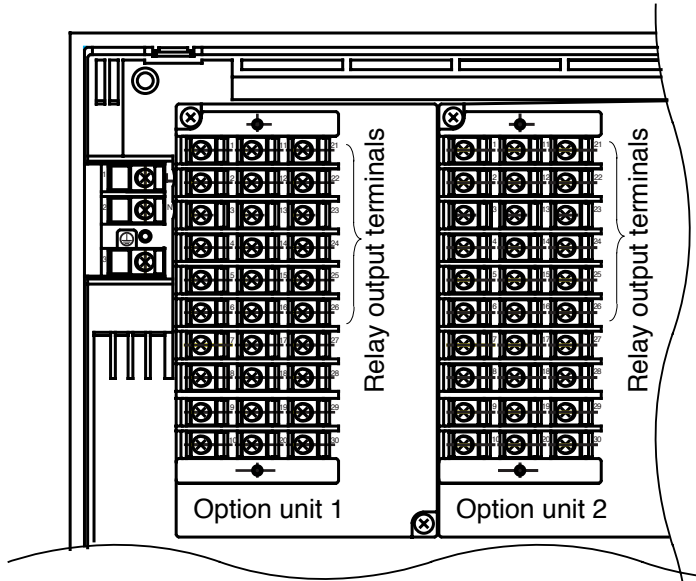

Option unit 1

Relay No.	Terminal No.		
	NO	COM	NC
1	1	11	21
2	2	12	22
3	3	13	23
4	4	14	24
5	5	15	25
6	6	16	26

Option unit 2

Relay No.	Terminal No.		
	NO	COM	NC
7	1	11	21
8	2	12	22
9	3	13	23
10	4	14	24
11	5	15	25
12	6	16	26

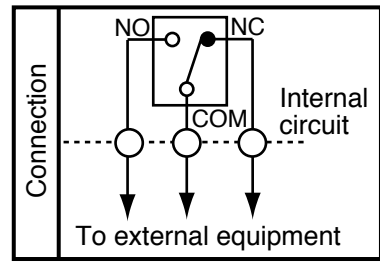



**■ Wiring Open Collector Outputs (optional function)**** WARNING**

Before wiring the SRF206/212/224, check the model numbers of instruments (including options) and terminal numbers on the affixed labels. When you have finished wiring, check the numbers again. Wiring the wrong lead to the wrong terminal might damage the main unit or cause a fire.

** CAUTION**

Do not connect the power supply with its polarities reversed.  
Doing so might damage the recorder.



Do not connect loads that exceed the maximum load current.  
Doing so might damage the recorder.



Do not short-circuit loads.  
Doing so might damage the recorder.



If necessary, attach a fuse or other overcurrent protection element on the external load.

** Handling Precautions**

Use an external power supply of the same voltage as the load.  
Otherwise, the clamp diode will not function.

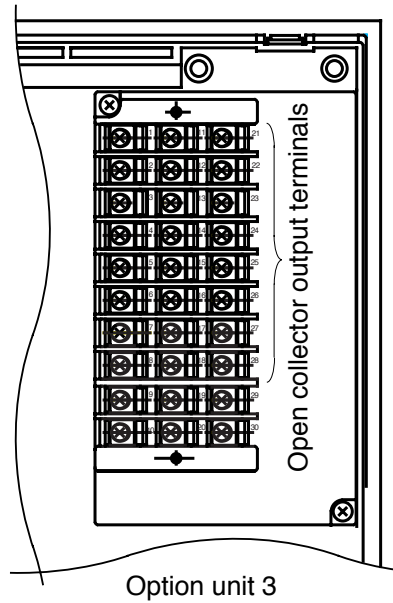

Terminal No.	Signal	Terminal No.	Signal	Terminal No.	
1	Open collector output 1	11	Open collector output 2	21	+Power
2	Open collector output 3	12	Open collector output 4	22	GND *2
3	Open collector output 5	13	Open collector output 6	23	GND *2
4	Open collector output 7	14	Open collector output 8	24	+Power
5	Open collector output 9	15	Open collector output 10	25	GND *2
6	Open collector output 11	16	Open collector output 12	26	GND *2
7	Closed at recorder ON	17	Closed at power ON	27	+Power
8	Closed at self diagnostics error	18	GND *2	28	GND *2

\*1: Mutually isolated

\*2: Terminal Nos. 18 and 28, 22 and 23, and 25 and 26 are internally connected at the terminal.

\*3: If even one of alarms AL01 to AL15 occurs, a self-diagnostics error will occur.

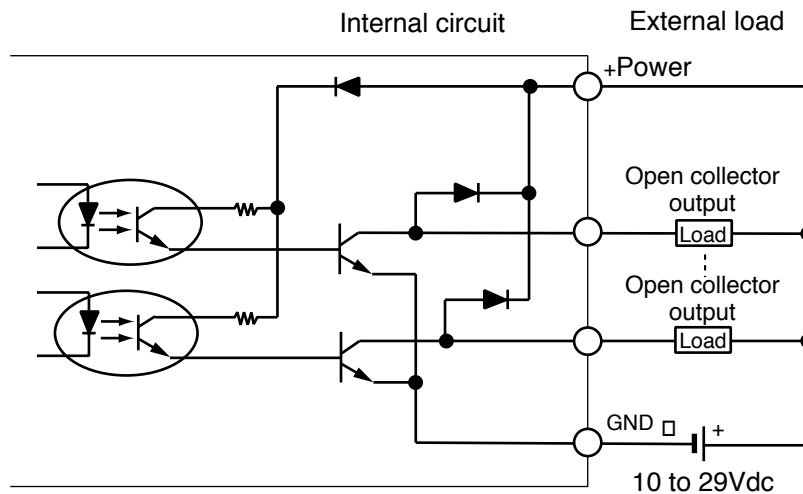

**Note**

Load drive power voltage	10 to 29Vdc (including power ripple)
Max. load current	70mA (per single output)
OFF leakage current	0.1mA max.
ON residual voltage	1.6V max.
Clamp diode forward current	70mA max.
Clamp diode reverse voltage	40V max.

■ Wiring External Switch Inputs (optional function)

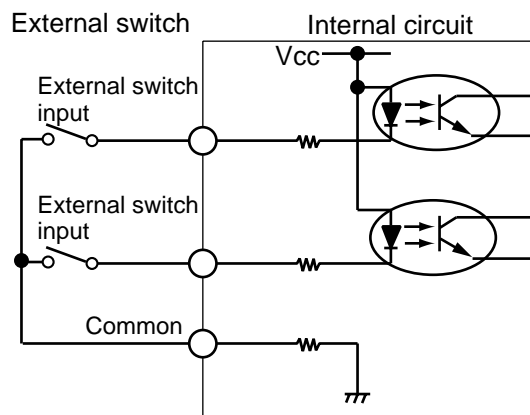
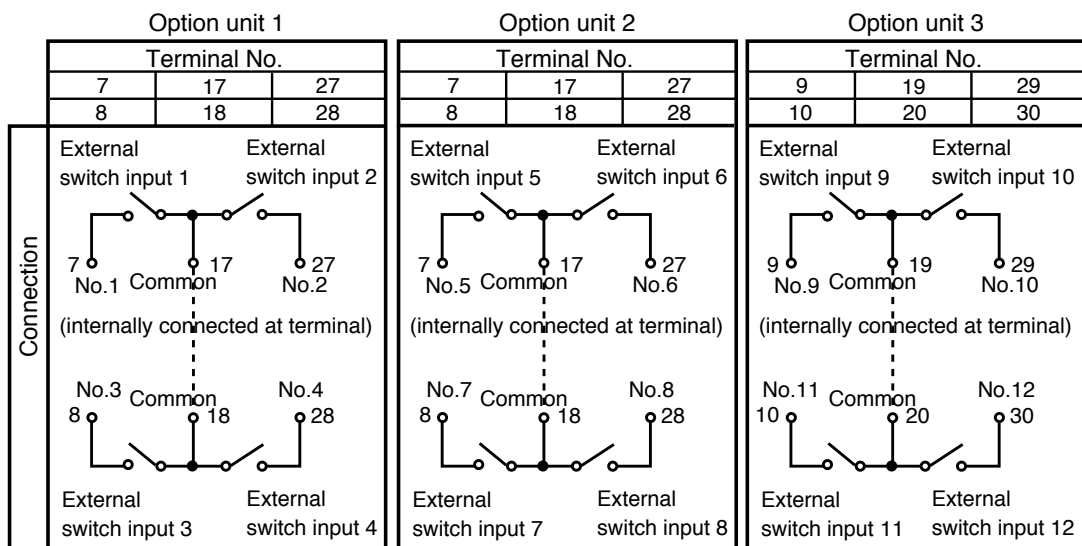
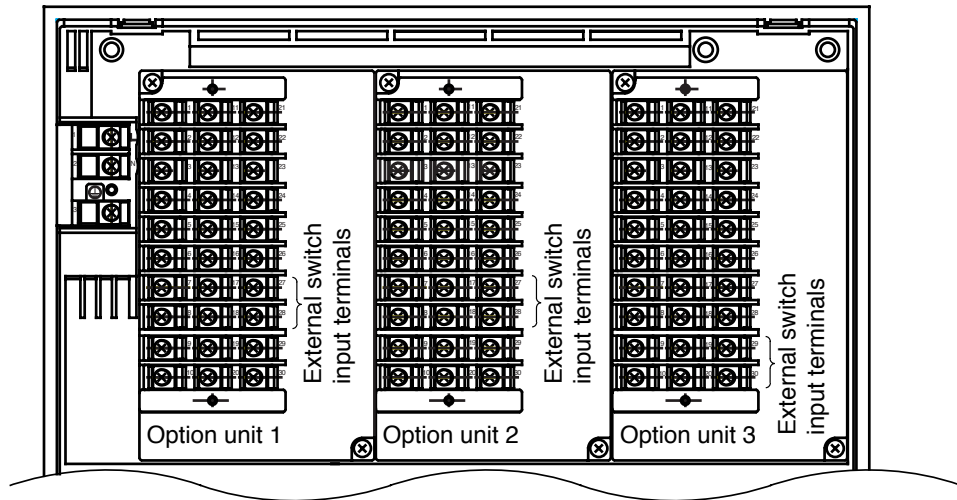

❗ Handling Precautions

The terminal positions on option unit 3 are different. Pay attention to this during instrumentation and wiring.

### ■ Connecting the RS-485 Interface (optional function)

Read this item when you are using a model that supports the RS-485 communications function.

The following shows an example with the RS-485 interface connected. In this example, the recorder is the slave station:

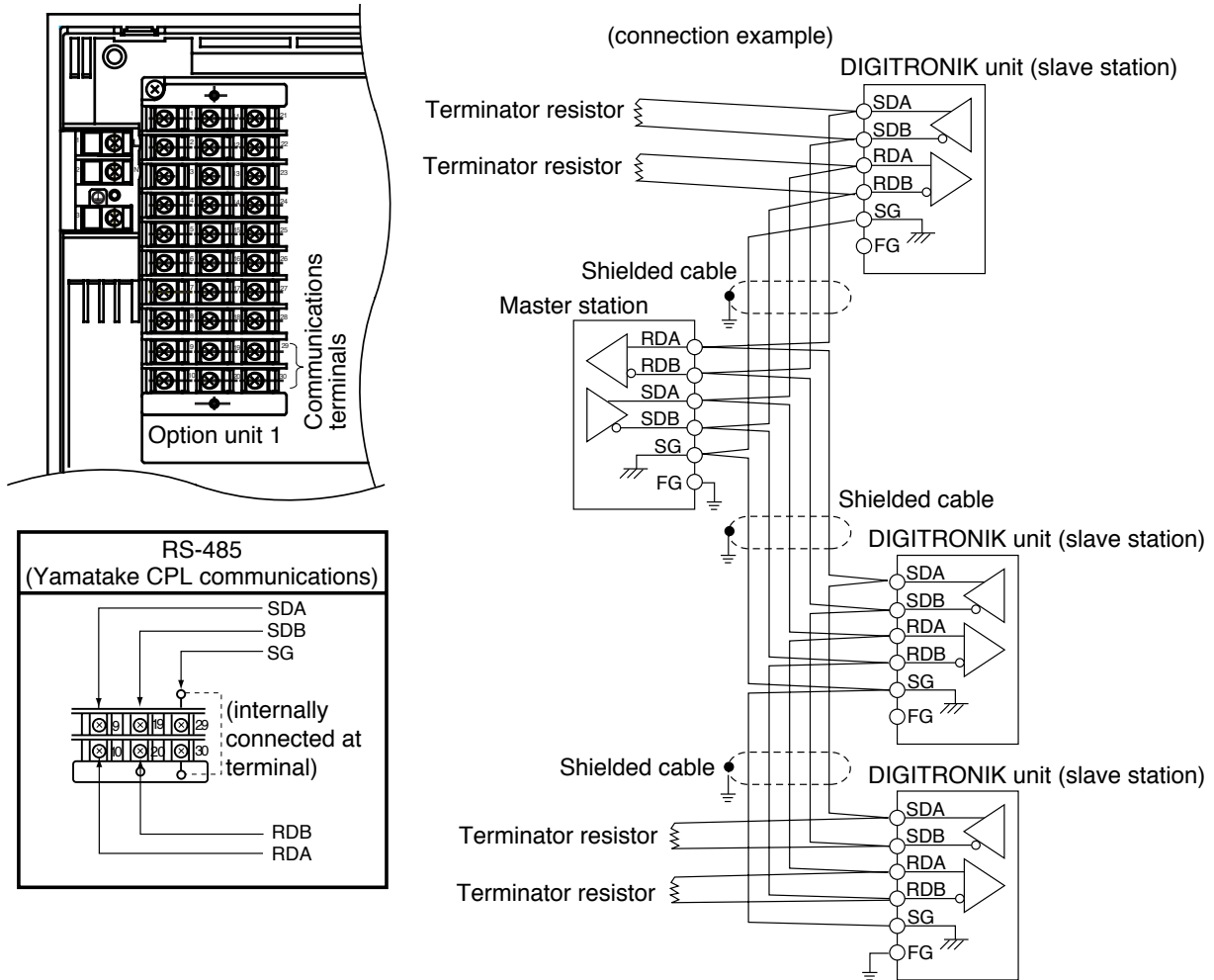

### ! Handling Precautions

Be sure to connect SG terminals each other.  
Failure to do so might cause unstable communications.

Provide terminators of resistance  $150\Omega \pm 5\%$ , 1/2W min. at both ends of the communications path.

Grounding of the shielded FG terminal should be carried out at only one end and not both ends.

■ **Connecting the RS-232C Interface (optional function)**

Read this item when you are using a model that supports the RS-232C communications function.

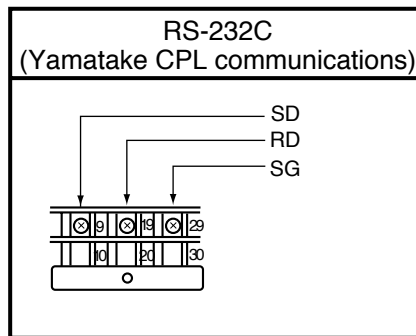
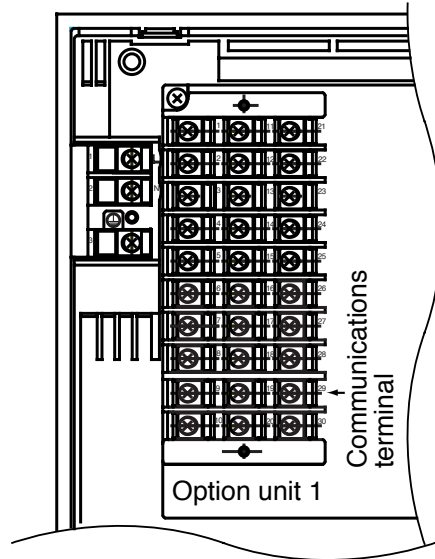

(connection example)

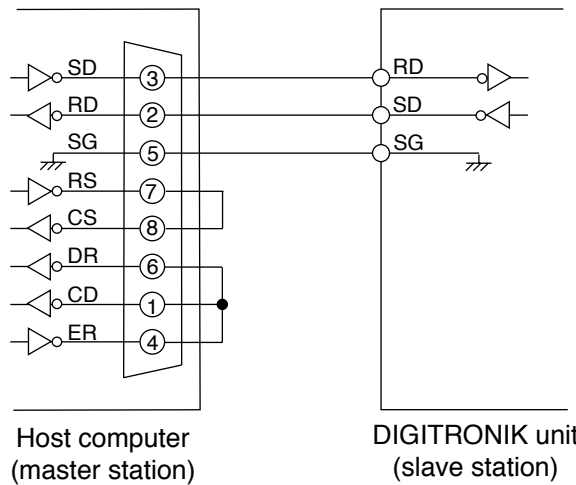

**Note**

Cable model No.: CBL232FNZ02  
 (2m cable for RS-232C, 9pin D-Sub socket contact-crimp-type terminal lug)



# Chapter 4. PREPARATION AND OPERATION

## 4 - 1 Preparation (loading the chart and ink ribbon cassette)

When a new recorder is shipped, the folding chart (hereafter referred to as the chart) and ink ribbon cassette are not loaded. When using this recorder for the first time, load the chart and ink ribbon cassette.

### ■ Loading the Chart

The chart can be loaded by removing chart cassette from the body even if it is attached to the main unit.

The following describes how to load the chart with the chart cassette attached to the main unit:

- (1) Before you load the chart, lightly fan the chart as shown in the figure below:



- (2) Open the door, pull down on both sides of the top edge of the chart guide, and draw out the chart guide towards you.

The chart guide can also be opened out downwards. (For details, see page 4-4.)

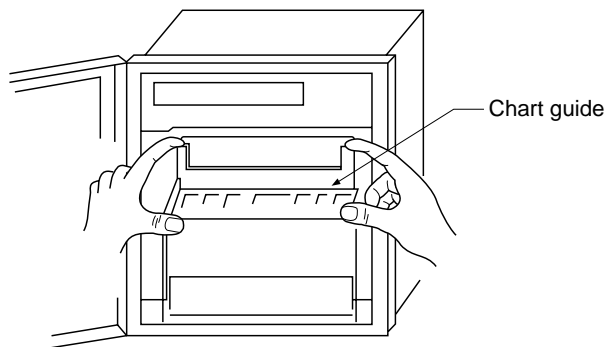

- (3) Press down on the PULL marks on the chart cassette, and pull the chart cassette towards you. The chart cassette breaks as you pull it down. However, slightly lift the entire cassette and lower it down until it becomes horizontal.

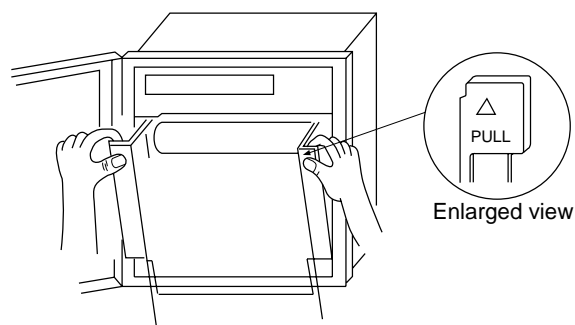

- (4) Hold the handle on the chart holder on the rear of the chart cassette and lift up the handle to open the chart holder.  
The chart holder comes to a stop at the fully open (innermost) position.

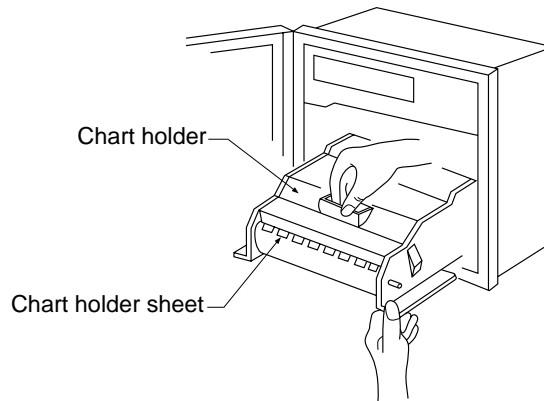

**! Handling Precautions**

Prevent the chart holder sheet on the edge of the chart holder from becoming deformed.

- (5) Insert the fanned chart into the chart holder making sure that it is facing the right way, and bring out the leading edge of the chart towards the chart guide. Load the chart so that the side of the chart with the printed scale is facing up and the end (red) mark is innermost.

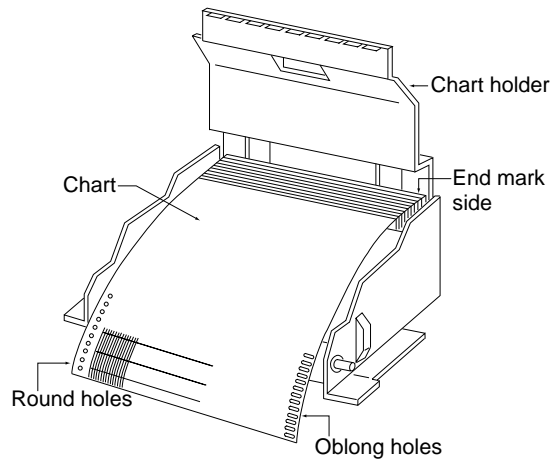

**! Handling Precautions**

A chart feed error will occur if the chart is not loaded correctly. Make sure that the oblong holes of the chart are located on the right side.

- (6) Hang three or five folds from the leading edge of the chart on the chart guide side, and correctly align them on the sprockets.

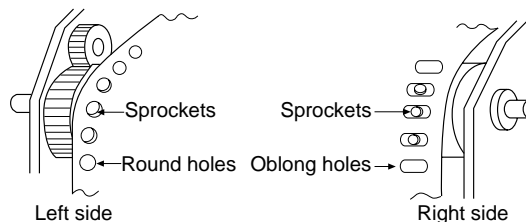



(7) Push the chart holder in so that it goes into the left and right latches.

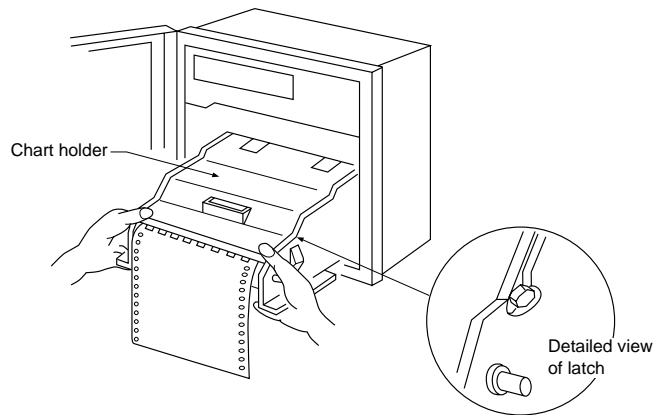

(8) Push in the chart holder so that it is firmly hooked onto the left and right latches of the chart guide.

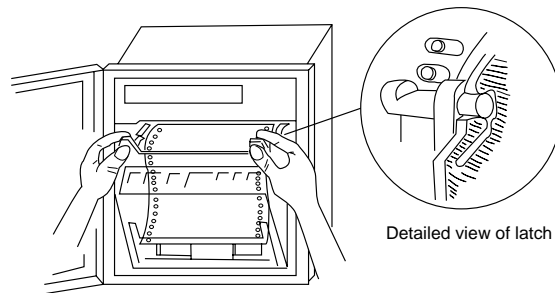

**! Handling Precautions**

Make sure that the time line on the chart is parallel with the top edge of the chart guide when viewed from the front.

(9) Correctly return the chart cassette to its original position, and push in the PULL marks on the left and right until you hear the chart cassette click into place.

(10) To remove the chart cassette from the main unit to load the chart, lift up the chart cassette in the state in step (3) and draw out.

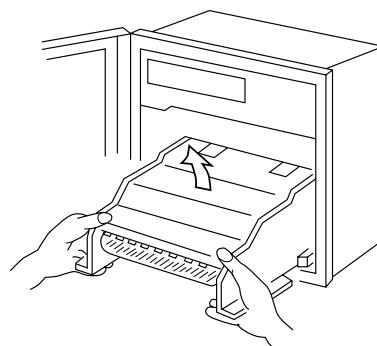

**! Handling Precautions**

Before you start recording after you have removed and re-attached the chart cassette, press the **FEED** key to feed the chart about one fold to make sure that the chart is being fed correctly.

 **Note**

The chart guide can also be drawn out downwards. Press the hooks on both sides at the bottom of the chart guide and draw out the chart guide towards you.

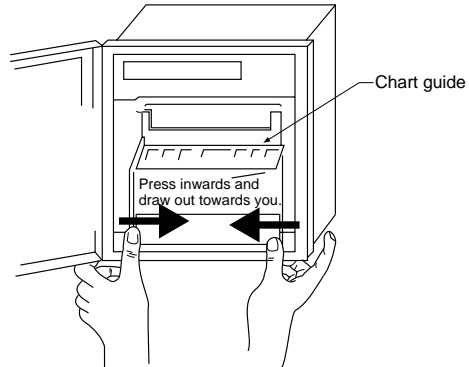

■ **Loading the Ink Ribbon Cassette**

- (1) Open the door and open the display setup unit towards you by pulling on the protrusion at the bottom left of the unit.

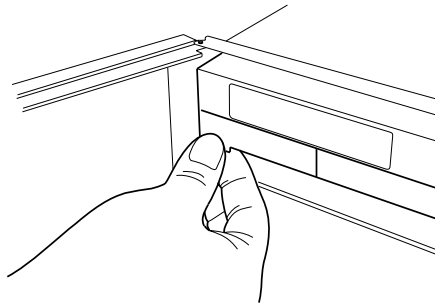

- (2) To replace the ink ribbon cassette, remove the old ink ribbon cassette. Push the release knob at the bottom left of the ink ribbon cassette up and swing the ink ribbon cassette out from the right side.

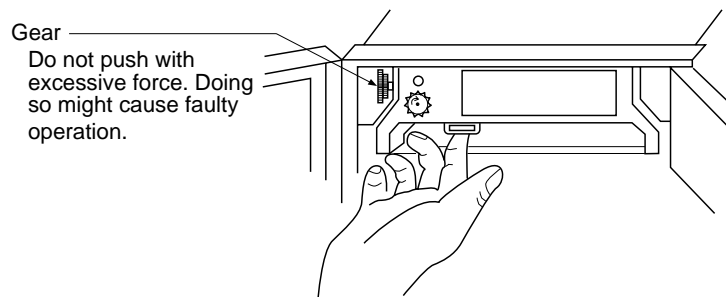

- (3) Insert the protrusion on the right of the new ink ribbon cassette into the hole on the ink ribbon cassette holder, and push in the release knob until you hear it click into place. The release knob enters the holder more easily if you push it in while rotating the ribbon feed knob.

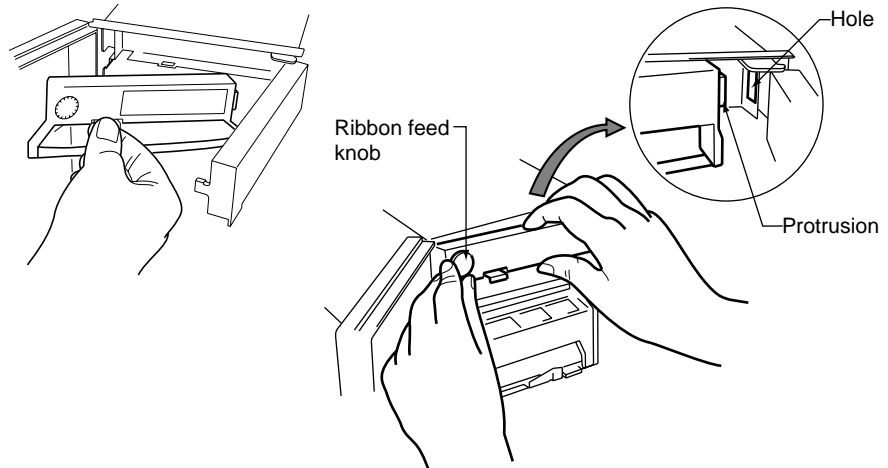

- (4) Make sure that the ink ribbon is inserted correctly between the wire dot head and the chart.

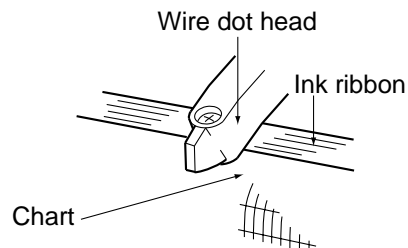

- (5) Turn the ribbon feed knob on the ink ribbon cassette in the direction of the arrow to take up any slack in the ribbon.

#### **!** Handling Precautions

- You cannot turn the ribbon feed knob on the ink ribbon cassette when the power is ON.
- The ribbon will not be fed smoothly if the ink ribbon cassette is not loaded correctly. This may result in color drift or the ribbon becoming entangled in the wire dot head.
- When you are not using the recorder for a long time, remove the ink ribbon cassette, put it in a vinyl bag and seal the bag to prevent the ribbon from drying. If the ink dries, prints will be faint or recording may no longer be possible.

- (6) Return the display setup unit to its original position.

#### **📖** Note

- Model No. of ink ribbon cassette: 81407408-001 (1 p'ce)
- The service life of the ink ribbon is about three months when feeding at a chart feed speed of 20mm/h.

## 4 - 2 Operation

### ■ Turning the Power ON

The recorder's power switch is located at the top right on the front when you open the door.

Pressing the power switch turns the power ON, and pressing it again turns the power OFF.

The internal check is automatically carried out within 30s of turning the power ON, and the recorder then enters the normal operating mode.

During the internal check, the model No. is displayed followed by the version number and then the date.

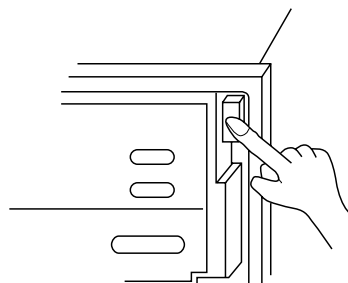

### ! Handling Precautions

During the internal check, the external switch inputs, relay outputs and open collector functions do not work.

### ■ Starting/stopping Recording

To start/stop recording, press the **RCD** key.

If you press the **RCD** key, the LED on the key lights and recording starts.

If you press this key again, the LED goes out, and recording stops.

When recording starts, the following items are printed out:

This is called "initial printing."

- Year/Month/Date
- Time (h/min)
- Recording format
- Chart feed speed
- Recorder ID No. (The ID No. is not printed when "00" is set as the ID No.)

### ! Handling Precautions

- Initial printing is not carried out when the power is turned OFF and then ON again in a recording start state.

At this time, the chart is automatically fed about 1mm, and then recording is resumed. The same operation is carried out in the event of an instantaneous power interruption.

- The recording stop/start state is held in memory even if the power is OFF. The same status is returned to when power is next turned ON.

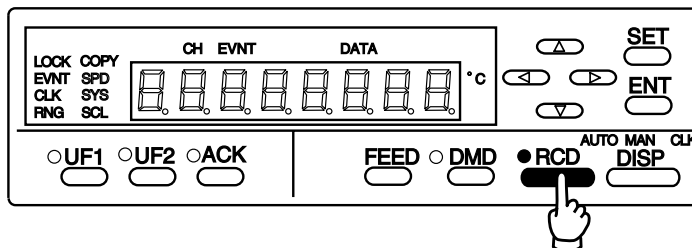

(example of starting recording)

1997/05/24	15:18	TREND	TAB	200mm/h	B07				
01-06ch	58.7	65.1	73.5	80.8	88.1	93.7			
07-12ch	1.5	2.5	3.5	4.5	5.5	6.5			
15:17									

## ■ Advancing the Chart

To advance the paper position when recording is stopped, hold down the **FEED** key.

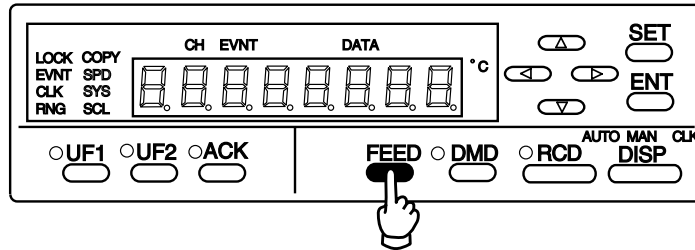

To stop chart feed, release your finger from the key.

### ! Handling Precautions

- You cannot operate the **FEED** key during recording.
- You cannot move the chart backwards using the **FEED** key. To move the chart backwards, remove the chart cassette, manually fold back the chart to its original position, and load the chart cassette into the main unit again.

## ■ Selecting the Display Mode

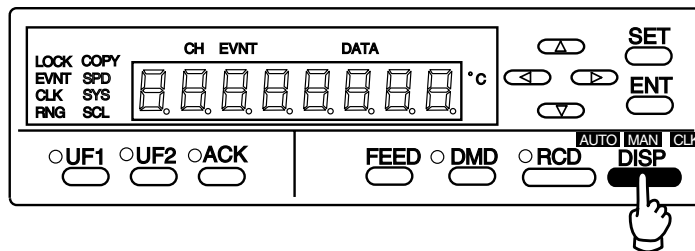

You can select four display modes by pressing the **DISP** key.

#### ◇ AUTO indicator

This mode successively displays the PV value of each channel at 4s intervals.

#### ◇ MAN indicator

This mode displays the PV value of specific channels. To move to the next channel, press the ▲ or ▼ key.

#### ◇ CLK indicator (year/month/date)

This mode displays the date.

#### ◇ CLK indicator (time)

This mode displays the time.

### ■ Recording a Specific Table

You can record a table (tabulation) of current PV values by pressing the  key.

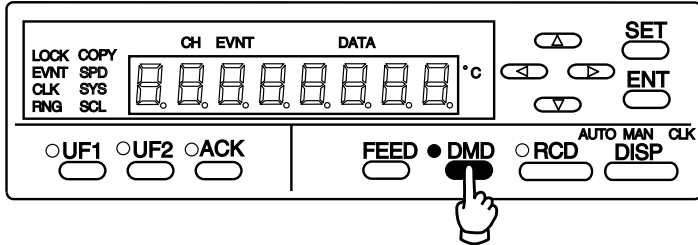

During recording  : A table of PV values is recorded overlaying trend data. The tabulation time varies according to the chart feed speed.

During recording stop  : Tabulation starts immediately, and ends in about 3min on 24-dot model recorders.

To cancel tabulation midway, press the  key again.

Pressing this key immediately stops tabulation. If you press this key during a recording stop, tabulation starts. If you press the  key during tabulation, recording starts after tabulation ends.

Tabulation is sometimes not performed at fixed times while tables are being recorded. For details of required recording times, see page 6-31.

Required Table Recording Times at a Chart Feed Speed of 20mm/h

Model	Required Time
6-dot printing	22min
12-dot printing	33min
24-dot printing	54min

(recording example when the  key is pressed during recording)

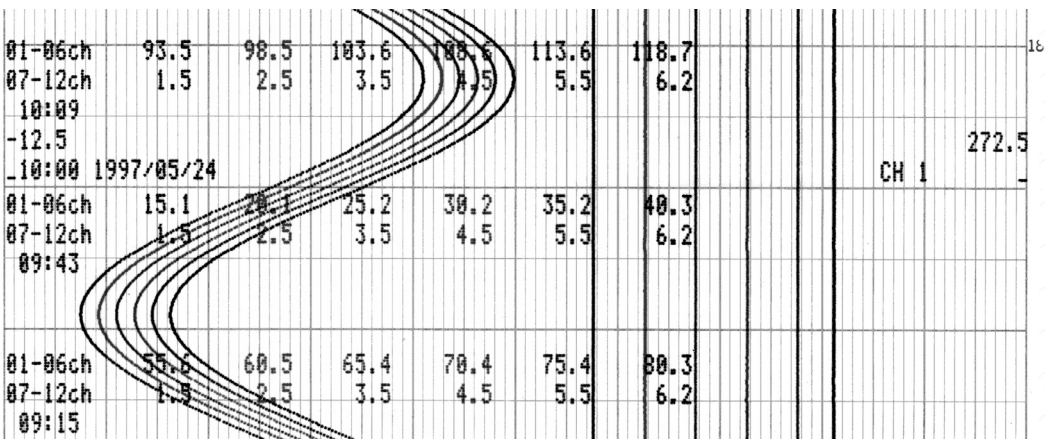

(recording example when the  key is pressed during a recording stop and the  key is pressed during tabulation)

1997/05/24 15:18		TREND	LAB	20mm/h	B07		
01-06ch	58.7	66.1	73.5	80.8	88.1	93.7	
07-12ch	1.5	2.5	3.5	4.5	5.5	6.5	
15:17							

### ■ Other Displays and Operations

#### ● Display when an event occurs

When an event occurs, the EVNT LED lights.

When the display mode is set to AUTO or MAN, the status of the event is displayed for the channel where the event occurred.



(Example)

The H (HIGH) event occurs on channel 1  
(PV value: 520.4)

- : HIGH (upper limit) event
- : LOW (lower limit) event
- : HIGH and LOW occur simultaneously

#### ● Configuration lock

“Configuration lock” is a feature for preventing the user from changing configuration setups by mistake. When the configuration is locked, setups can be confirmed but not changed.

When the configuration is locked, the LOCK LED lights. For details on how to cancel configuration lock, see ■ **Canceling Configuration Lock** (page 5-4).



**Note**

Configuration lock can be set on the user function keys.

### ■ Printout Details

#### ● Printout messages (purple)

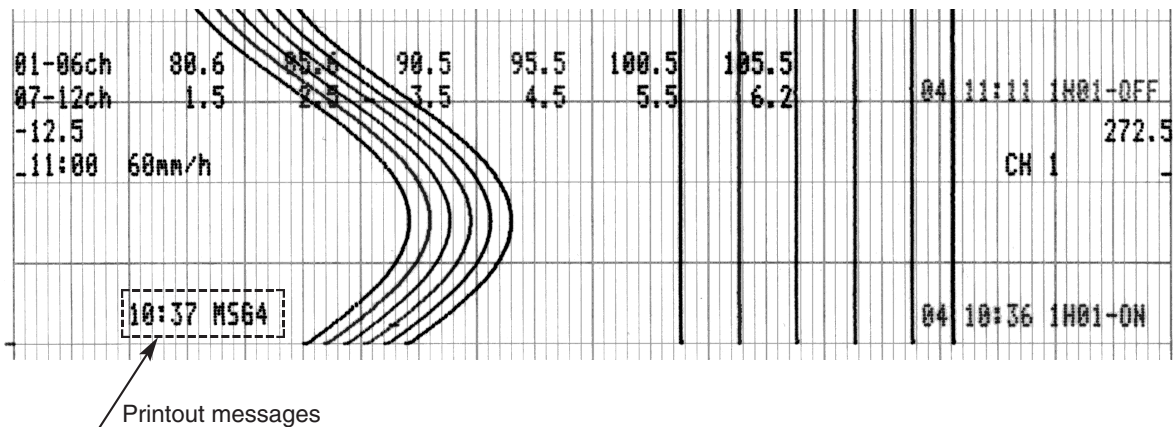

**Note**

For details, see **6-12 Message Setup** (page 6-32).

● Example of trend + tabulation recording

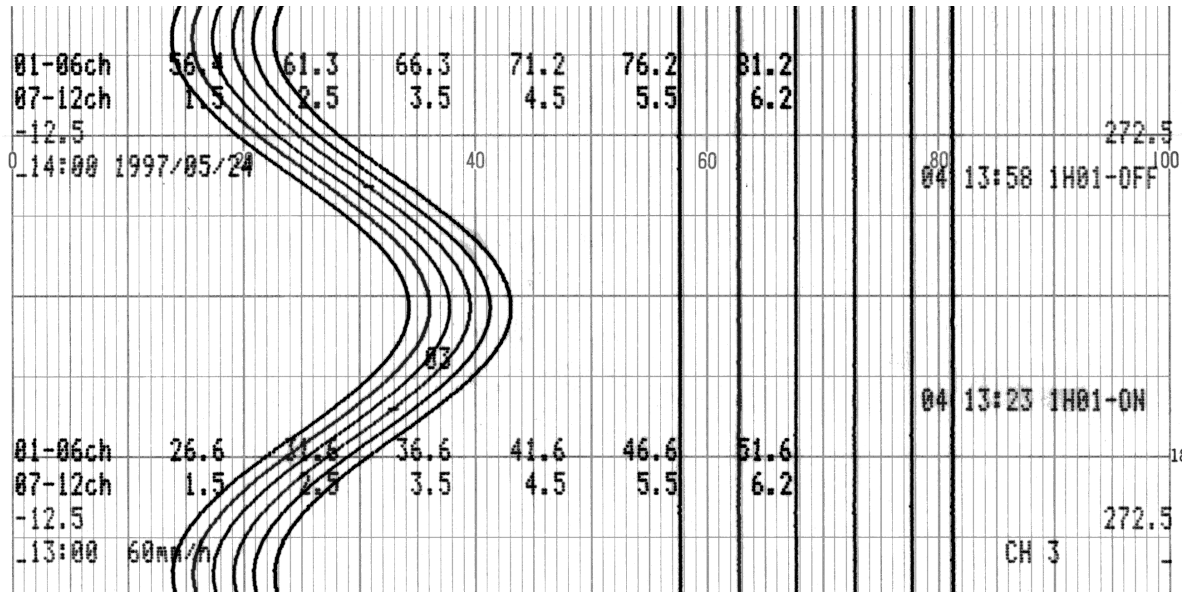

● Example of trend + schedule demand

Same as trend + tabulation recording

● Example of trend recording

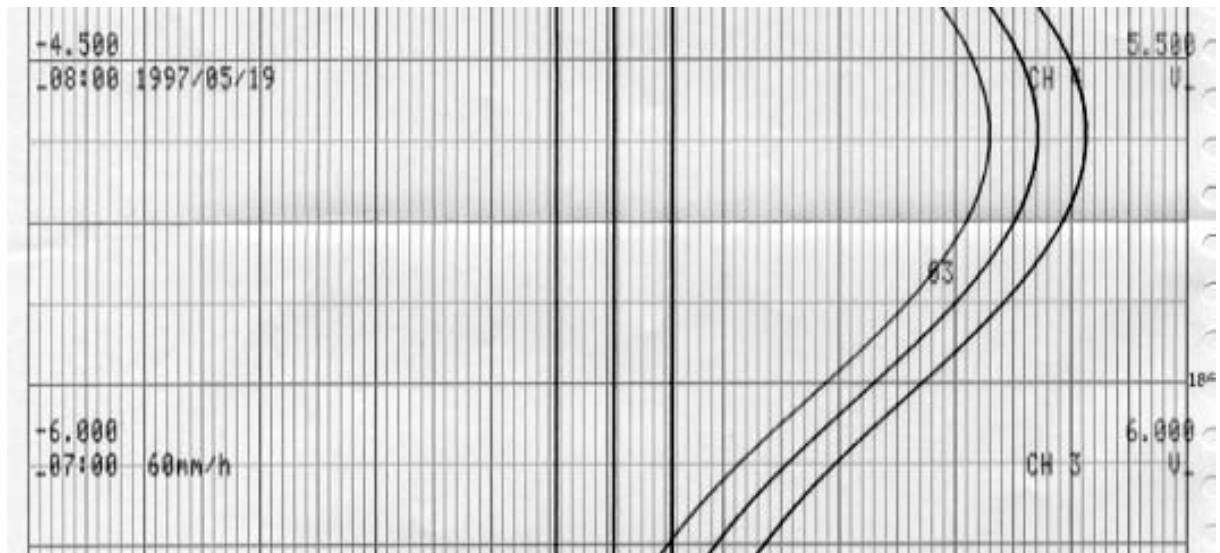



---

- Example of fixed interval tabulation

1997/06/08 15:40	01:	23.4	02:	23.4	03:	23.4	04:	23.4	05:	23.4	06:	23.4	14
1997/06/08 15:30	01:	23.4	02:	23.4	03:	23.4	04:	23.4	05:	23.5	06:	23.5	
1997/06/08 15:20	01:	23.5	02:	23.5	03:	23.5	04:	23.4	05:	23.5	06:	23.5	
1997/06/08 15:10	01:	23.5	02:	23.5	03:	23.5	04:	23.5	05:	23.6	06:	23.6	
1997/06/08 15:00	01:	23.5	02:	23.5	03:	23.5	04:	23.5	05:	23.5	06:	23.5	

- Example of fixed time tabulation

Same as fixed interval tabulation recording

■ Replacing the Chart

**⚠ CAUTION**



Load the chart and ink ribbon cassette either with the power OFF or with the recorder stopped (the RCD LED should be OFF). Do not push the cassette with excessive force. Doing so might force a movement of the ink ribbon cassette holder (see page 4-4), damaging the gear and causing faulty operation.

First, turn the power OFF, or press the  key to stop recording (the RCD LED should be OFF).

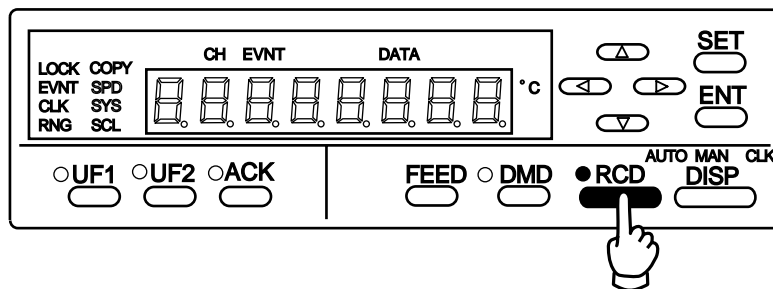

For the procedure to follow, refer to:

 ■ Loading the Ink Chart (page 4-1).

## ■ Replacing the Ink Ribbon Cassette

### ⚠ CAUTION



Load the chart and ink ribbon cassette either with the power OFF or with the recorder stopped (the RCD LED should be OFF). Do not push the cassette with excessive force. Doing so might force a movement of the ink ribbon cassette holder (see page 4-4), damaging the gear and causing faulty operation.

First, turn the power OFF, or press the  key to stop recording (the RCD LED should be OFF).

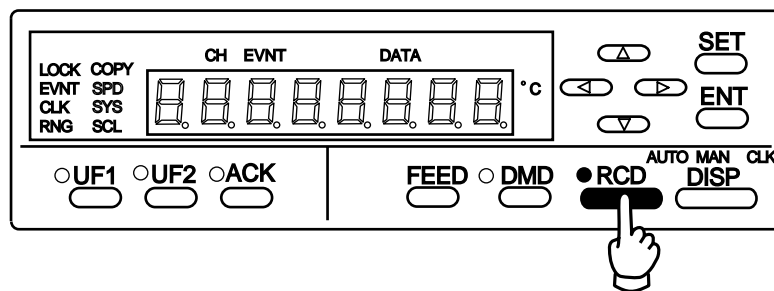

For the procedure to follow, refer to:

 ■ Loading the Ink Ribbon Cassette (page 4-4).



# Chapter 5. BASIC CONFIGURATION

## 5 - 1 Introduction

To use the SRF206/212/224, you must first select the input range type, and set the recording scale, chart feed speed and other items. This setup is called “configuration.”

Configuration is sometimes already set up by the device manufacturer in which the SRF206/212/224 is integrated. If the SRF206/212/224 has not been configured or you want to change the configuration setups, refer to **Chapter 6. DETAILED CONFIGURATION.**

On the SRF206/212/224, configuration is divided into two stages:

- For personnel who normally operate the SRF206/212/224
- For personnel who initially set up the SRF206/212/224.

This chapter describes the setup items listed below whose settings are changed relatively often in normal operation.

The configuration is set up in the extended menu. This menu has three menu levels as shown in the figure below.

Menu level 0 has six setup items.

Menu level 1 has an additional five setup items.

Menu level 2 has all setup items.

**Chapter 6, DETAILED CONFIGURATION** describes all of these setup items.

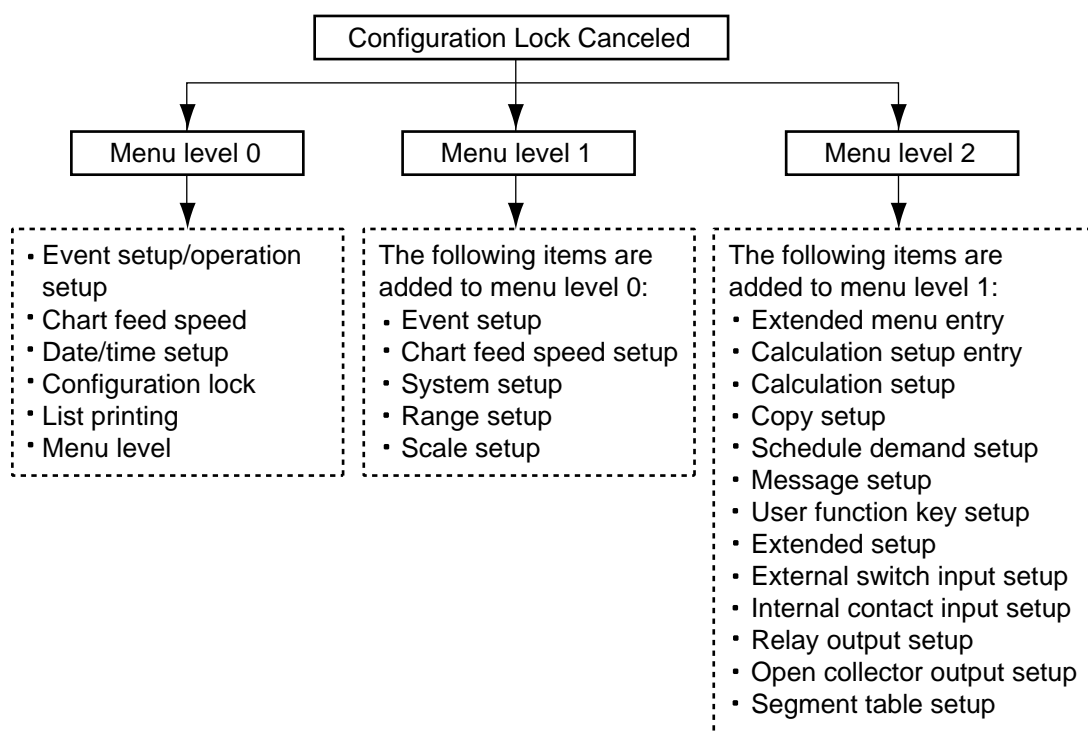

### Note

When the configuration is locked, setups can be displayed for confirmation but not changed. (The configuration lock can be canceled at any time.)

### Handling Precautions

Data setups can be changed during recording. However, note that once range type or other items are changed, display or recording sometimes malfunctions temporarily.

## 5 - 2 Basic Key Operations at Setup, Configuration Lock and Menu Levels

### ■ Basic Key Operations at Setup

This section describes common operations at setup.  
The figure below shows the display setup unit.

- To start configuration setup

Press the **SET** key.

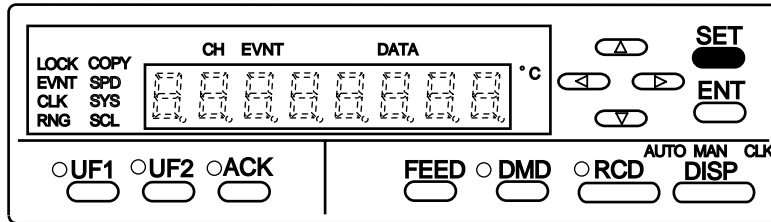



- To change configuration items

Press the **SET** key to advance to the next display number.

- To quit configuration

Pressing the **DISP** key in any situation quits configuration.



### ● To advance to the next display number





Press the  key. The cursor shifts to the display number digit (red LED). Press the  /  keys to shift the display number.



#### Note

If you have not changed the numerical values of a setup item, pressing the  key shifts the display number without changing the setup.

### ● To change data

Shift the cursor (blinking digit) using the  /  keys to DATA.

Press the  /  keys to determine the data, and set the data with the  key. Pressing the  /  keys increments/decrements numerical values to increase or decrease digits.



When the valid maximum or minimum value of the data is reached, pressing the  /  keys does not change the numerical value. To set the numerical value, press the  key.

#### Note

To cancel changing of data midway, press either of the following keys without pressing the  key. Any changes made to the currently displayed data at this time are implemented.

 key: Quits configuration

 key: Advances to the next setup.

You can advance the display number without changing the data by pressing the  /  keys after shifting the cursor to the display number digit (red LED).

#### Handling Precautions

If a setting value is in error, all data will blink when you press the  key. If this happens, press any key to return to the entry display. Check the setting values, and reset them if necessary.

## ■ Canceling Configuration Lock

When the configuration is locked, the LOCK LED lights and the configuration setup cannot be changed.

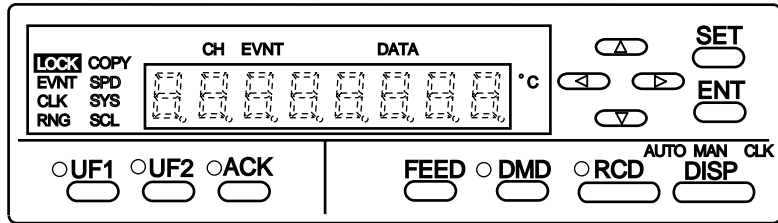

To cancel configuration lock, follow the procedure below:

- (1) Press the **SET** key to select SYS.
- (2) Change the configuration lock setting from “1” to “0” in display number 1.
- (3) Press the **ENT** key.



The LOCK LED goes out to indicate that the configuration lock is canceled.



---

## ■ Changing the Menu Level

You can change the menu level so that you can initially set the range type, recording scale and other setup items.

- (1) Press the  key to select SYS. Select display number 3 using the ▲ / ▼ keys.
- (2) Change the menu level.
- (3) Press the  key.

## 5 - 3 Changing Event Setting Values

### Handling Precautions

Event setting values are displayed only when “H” or “L” is set as the event type.

For details on how to set up event types, see **6-3 Event Setup** (page 6-11).

The decimal point position of event setting values is the decimal point position determined by the range code in the case of range codes 10 onwards. In the case of range code 00 to 06 voltage inputs, this becomes the engineering range decimal point position that is set in **6-7 Range Setup**, range setup procedure step (8) (page 6-19).

### ■ Starting Setup

Press the  key to select EVNT.

Make sure that the EVNT LED lights.

### ■ Selecting the Target Channel No.

Select the channel No. to be set using the ▲ / ▼ keys.

The following example shows the display setup unit when channel 2 is selected:

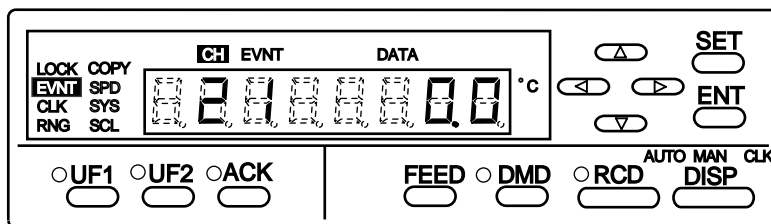

## ■ Selecting the Target Event No.

Up to four events can be set to a single channel. Select which event No. is to be set. Event No.1 will be displayed with the target channel selected.

Shift the cursor to the display number digit, and select the digit using the ▲ / ▼ keys.

The following example shows the display setup unit when event setting value is selected:

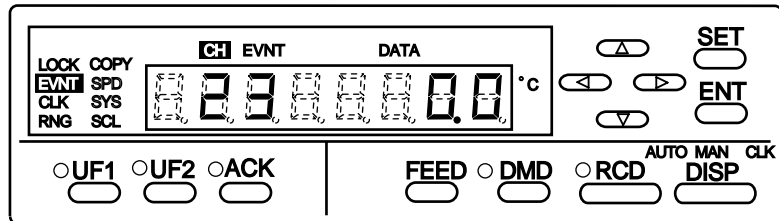

## ■ Enabling Changing of Event Setting Values

- When you can select the target event No. of the target channel, you can change that event setting value.
- Pressing the ▲ / ▼ keys shifts the cursor from the channel to the lowermost digit of the setup item at DATA, and DATA is no longer zero-suppressed.

## ■ Entering Event Setting Values

Enter event setting values using the ▲ / ▼ or ◀ / ▶ keys.

When you have set the numerical values, press the **ENT** key. This registers the setting value to memory, and automatically advances the display to the next display number.

## 5 - 4 Changing the Date/Time

### Handling Precautions

If both the date and time are in error, all data will blink when you press the **ENT** key to notify that entry is no longer possible. If this happens, press any key to return to the entry display.

The number of seconds in the time setting are reset (so that counting starts from “00”) when you press the **ENT** key, only when the numerical values for the time setting are changed. If you press the **ENT** key without making any changes to the numerical values for the time setting, the date setting display will be redisplayed, and the number of seconds will not be reset.

### ■ Starting Setup

Press the **SET** key to select CLK.

Make sure that the CLK LED lights.

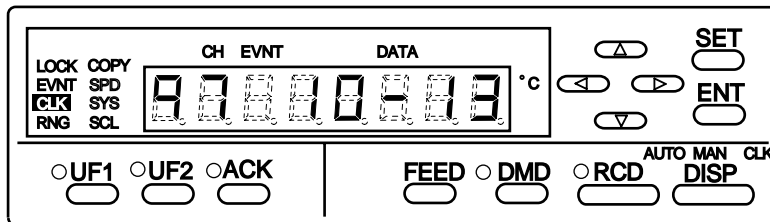

### ■ Changing the Date

The date is arranged in order year (lower two digits of Western calendar), month then day. Shift the cursor to the part of this item that you want to change using the **◀/▶** keys, and change the numerical value using the **▲/▼** keys. Leap years in dates are automatically adjusted. To set the year “2000”, enter “00” as the year. When you press the **ENT** key, the time setting screen is redisplayed.

### ■ Changing the Time

The time is arranged in order hours (24h clock) then minutes. Shift the cursor to the part of this item that you want to change using the **◀/▶** keys, and change the numerical value using the **▲/▼** keys. When you press the **ENT** key, the data setup display is redisplayed.

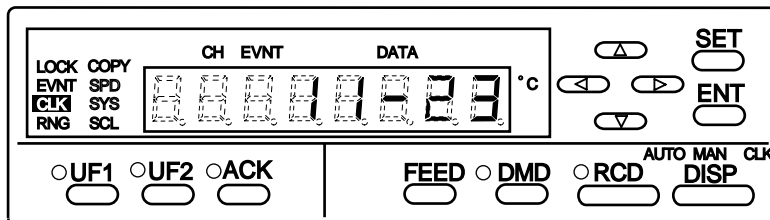

## 5 - 5 Printing Lists

### Handling Precautions

Lists can be printed when printing has stopped.

Lists are printed for checking or saving setup details.

The SRF206/212/224 is provided with the following printing options:

- Print specified lists: Outline of main setup items such as range, scale and event setup  
For details, see page 5-10.
- Print function lists (A): Range setup, scale setup
- Print function lists (B): Event setup, external switch input setup, internal contact input setup
- Print function lists (C): Message setup, schedule demand setup, user function setup, communications setup, extended setup
- Print function lists (D): Segment table setup
- Print all lists: All setups of function lists (A) to (D)
- Print communications lists: Details set by CPL communications or personal computer loader

Selecting “1” to “7” starts printing of lists. When printing of lists ends, the printing list selection is automatically cleared to “0”.

To automatically start recording after a list has been printed, press the  key after printing of lists has started. In this case, the RCD LED lights.

### Note

The following table shows the approximate times it takes to print each of the lists. The time required to print a list varies according to the setup.

	6-dot	12-dot	24-dot	Remarks
Specified list	5min	8min	15min	Varies according to number of used channels
Function lists (A)	7min	13min	25min	
Function lists (B)	6min	10min	19min	
Function lists (C)	4min	4min	4min	
Function lists (D)	7min	7min	7min	
All list	22min	32min	53min	
Communications list	1min			Varies according to details to print out

### ■ Stopping Recording



Press the  key to stop recording midway.

### ■ Starting Setup

Press the  to select SYS.

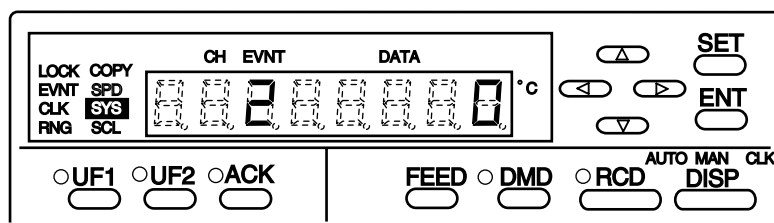
Make sure that the SYS LED lights.



Shift the cursor to the display number digit using the  key, and press the  key to shift to the 2nd display number from where the list is to be printed.

### ■ Selecting the List to be Printed

Press the **▶** key to shift the cursor to DATA, and select the desired list using the **▲** / **▼** keys.

Pressing the **ENT** key starts printing of lists, and the display advances to the next display number.

The following example shows printing of specified lists selected:

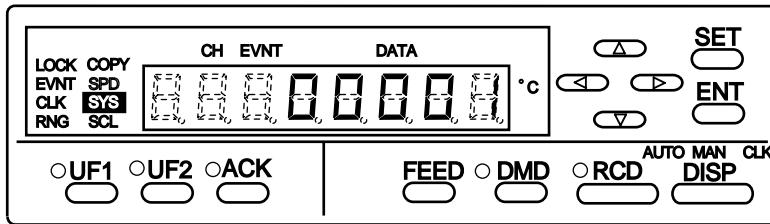

### ■ Stopping List Printing Midway

To stop list printing midway, shift to display number 2, enter "0" using the **▲** / **▼** keys, and press the **ENT** key.

(example of specified list printing)

PARTIAL LIST Ver0.17						
1997/05/28 14:28		TREND+TAB	CHART SP1 60mm/h	INTERVAL1 03:00	ID=01	
			CHART SP2 120mm/h	INTERVAL2 18:00		
CH No.	RANGE CODE	SCALE	1	EVENT 1	EVENT 2	
TAG No.	PU BIAS	2		3	4	
01	23:K	0.0	1200.0	200.0 L	1000.0 H	
233001A	0.0	---	---	OFF	OFF	
02	05:±5V-LIN	1.000	5.000	OFF	OFF	
70777A	0.500	---	---	OFF	OFF	
03	20:R	# 700.0	# 800.0	600.0 L	500.0 L	
233003B	0.0	800.0	900.0	1000.0 H	1100.0 H	
04	15:±5V	-5.000	5.000	OFF	OFF	
70777B	0.000	---	---	OFF	OFF	
05	90:DIGITAL(23)	50.0	---	---	---	
74777	---	---	---	---	---	
06	40:Pt100	-50.0	100.0	-20.0 L	80.0 H	
233006C	0.0	---	---	OFF	OFF	

### ■ Print Communications List

(example of communications list printing)

通信日時 300000		
通信元	通信先	送信データ
1997/05/28 14:28	1997/05/28 14:28	[ ]
1997/05/28 14:28	1997/05/28 14:28	L510

---

## ■ Print Specified Lists

With print specified lists, all items in channels for which recording is currently set to OFF are not printed.

### ● Print items

- Header  
Date/time (h:min), recording format, No.1 or No.2 chart feed speed, fixed date/fixed time interval, recorder ID No.  
Each of these printing items are printed unconditionally as the header. (The header is printed even if recording of all channels is set to OFF.)
- Channel No./Tag
- Range code/PV bias  
The PV bias is printed as “-” for the communications input range and ON/OFF input range.
- No.1, No.2 scale (scale upper/lower limit)  
The No.2 scale upper and lower limits are printed as “-” on channels on which the scale selection setting is set to OFF.  
The scale lower limit is printed as “%” and the scale upper limit is printed as “-” for the ON/OFF range.  
When scale selection is not set to OFF, “#” is printed appended to the currently selected scale.
- Event setup 1 to 4 (event setting value, event type)  
Events whose event operation setting is set to OFF are printed as “OFF” and the event setting values are not printed.  
Even events for which recording is set to OFF are printed unless the event type is OFF.

● Example of details printed by print specified lists

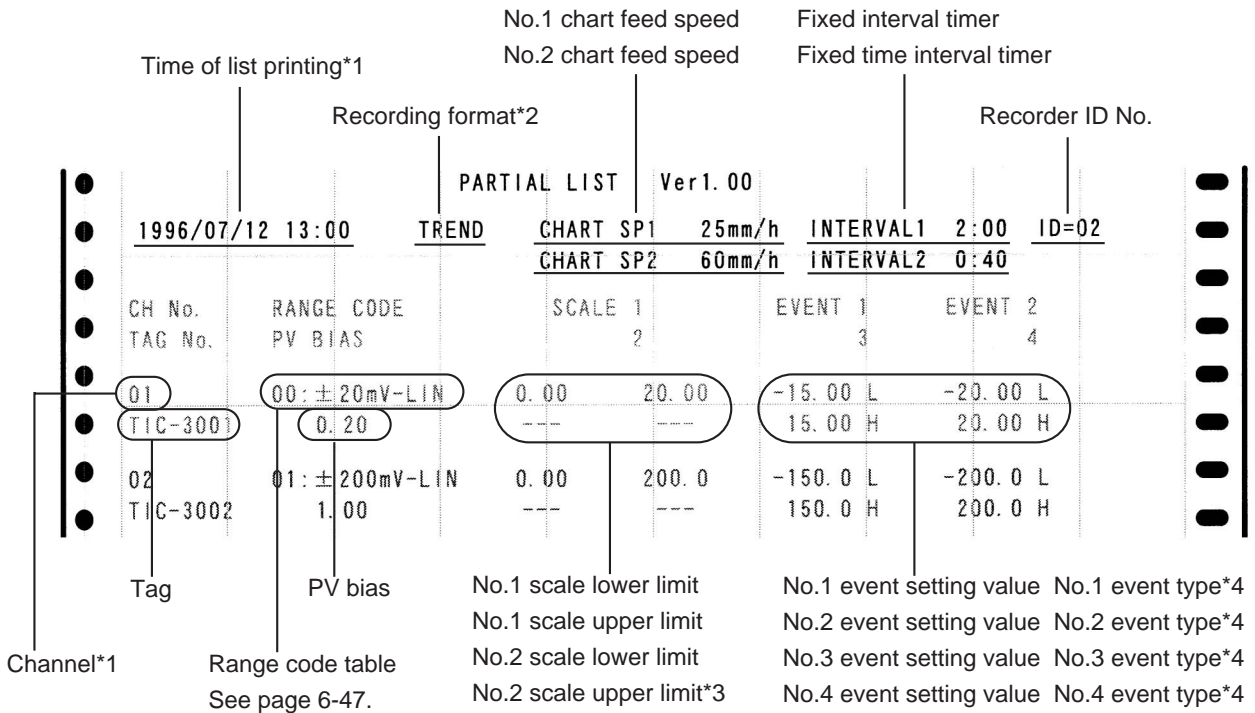

\*1: This is not a setup item.

\*2: Recording format

- TREND: trend
- TREND + TAB: trend + tabulation
- TREND + SDMD: trend + schedule demand
- TAB (TIME): fixed interval tabulation
- TAB (ITVL): fixed time tabulation

\*3: When scale switching method is set to "0" (OFF), "--- ---" is displayed as the No.2 scale lower limit/No.2 scale upper limit.

\*4: event type

- H: upper limit
- L: lower limit

-: When set to OFF, "OFF" is printed.

**!** Handling Precautions

Channels for which recording is set to OFF are not printed.



## Print All Lists

### ● Example of print all lists (range) details

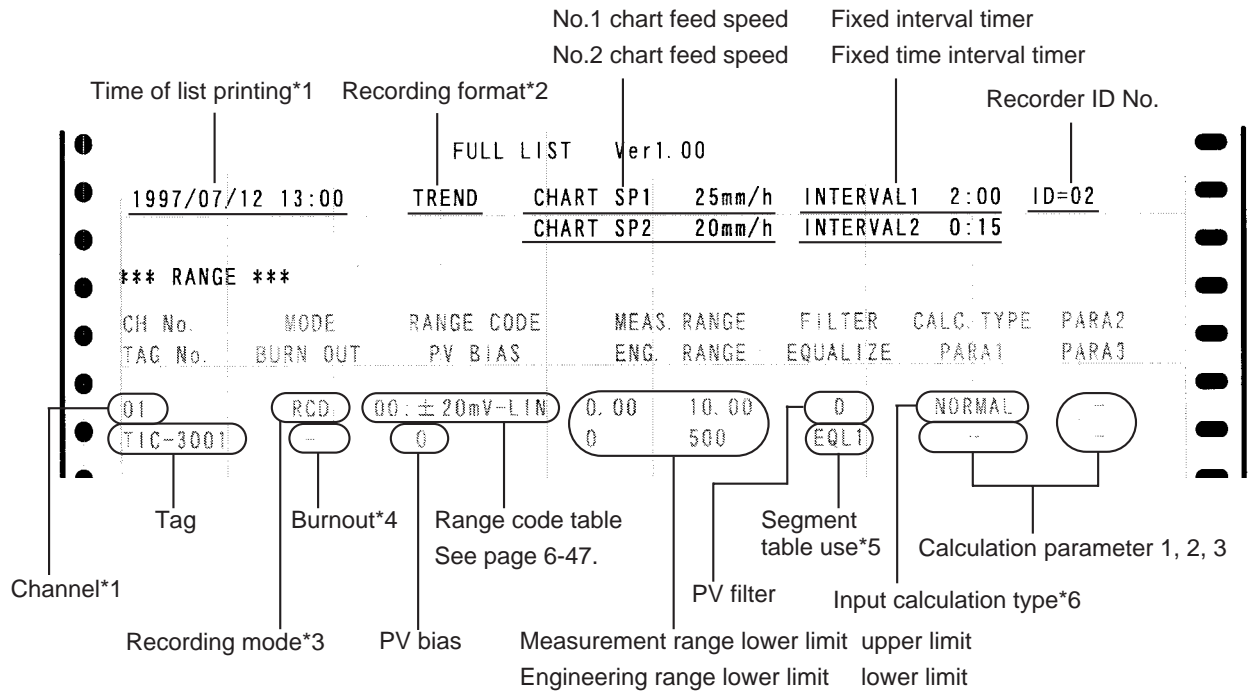

\*1: This is not a setup item.

\*2: Recording format

TREND: trend

TREND + TAB: trend + tabulation

TREND + SDMD: trend + schedule demand

TAB (TIME): fixed interval tabulation

TAB (ITVL): fixed time tabulation

\*3: Recording mode

OFF: OFF

DISP: Display

RCD: Display + recording

DI: digital input-dependent

\*4: "-" is printed in the case of inputs other than a thermocouple.

\*5: Segment table use

OFF: Use disabled

EQL1: Use segment table 1

EQL2: Use segment table 2

EQL3: Use segment table 3

\*6: Input calculation type

NORMAL: OFF (PV value)

PICH-P2CH: A channel - B channel

DEV (DATA-): Fixed value - current channel

DEV (-DATA): Current channel - fixed value

INTEGRAL: Integrating calculation

F.VAL CALC: F value calculation

%RH CALC: Relative humidity calculation

● Example of print all lists (scale) details

*** SCALE ***								
CH No.	SCALE 1		SCALE 2		UNIT	TYPE	SCALE CHANGE	
	LOWER	UPPER	LOWER	UPPER			POINT	DIFF
01	10.0	40.0	-	-	MPa	OFF	-	-
02	0.0	50.0	0.0	100.0	%	AUTO	40.0	1.0
03	500	1000	-	-	hPa	OFF	-	-

Channel*1	No.1 scale lower limit	No.1 scale upper limit	No.2 scale lower limit*2	No.2 scale upper limit*2	Engineering unit	Scale switching method*3	Auto-switching point*2	Scale switching differential*2
-----------	------------------------	------------------------	--------------------------	--------------------------	------------------	--------------------------	------------------------	--------------------------------

\*1: This is not a setup item.

\*2: When scale switching method is set to "0" (OFF), "-" is displayed.

\*3: Scale switching method

OFF: OFF

AUTO: Automatic

REM: Selected by internal contact input, external switch input or CPL communications input

● Example of print all lists (events) details

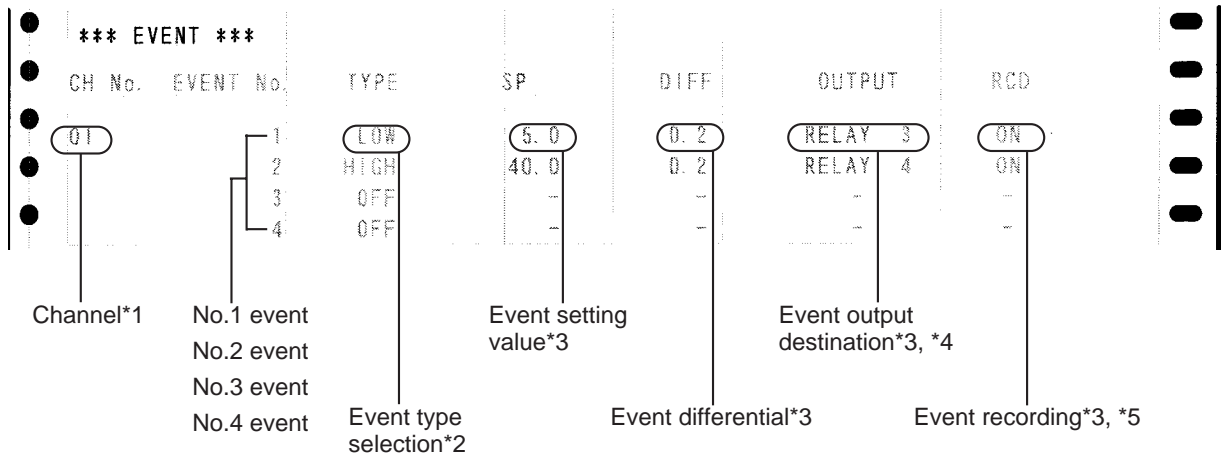

\*1: This is not a setup item.

\*2: Event type selection

OFF: OFF

HIGH: Upper limit

LOW: Lower limit

\*3: When event type selection is set to "0" (event OFF), "-" is displayed.

\*4: Event output destination

-: OFF

RELAYn: Output to No.n relay

O.C.DOn: Output to No.n open collector output

INTERNALn: Output to No.n internal contact input

\*5: Event recording

OFF: Event recording OFF

ON: Event recording ON

● Example of print all lists (DI/DO) details

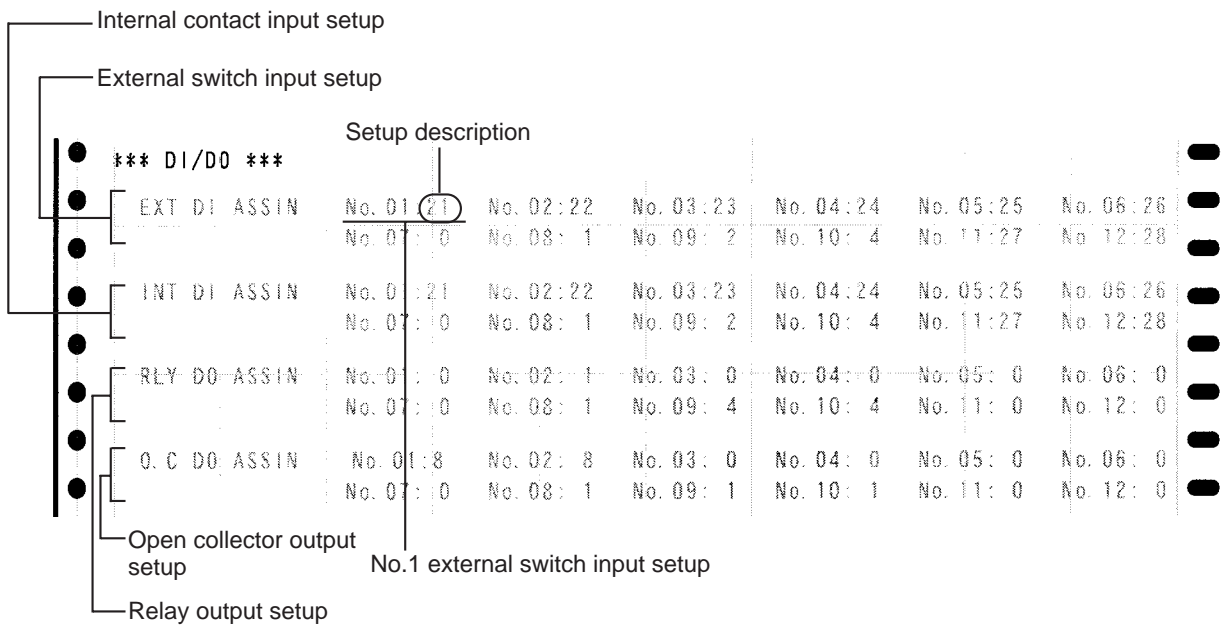

For details of setup items, see page 6-9.

● Example of print all lists (other) details

User function assignment 1 to User function assignment 8

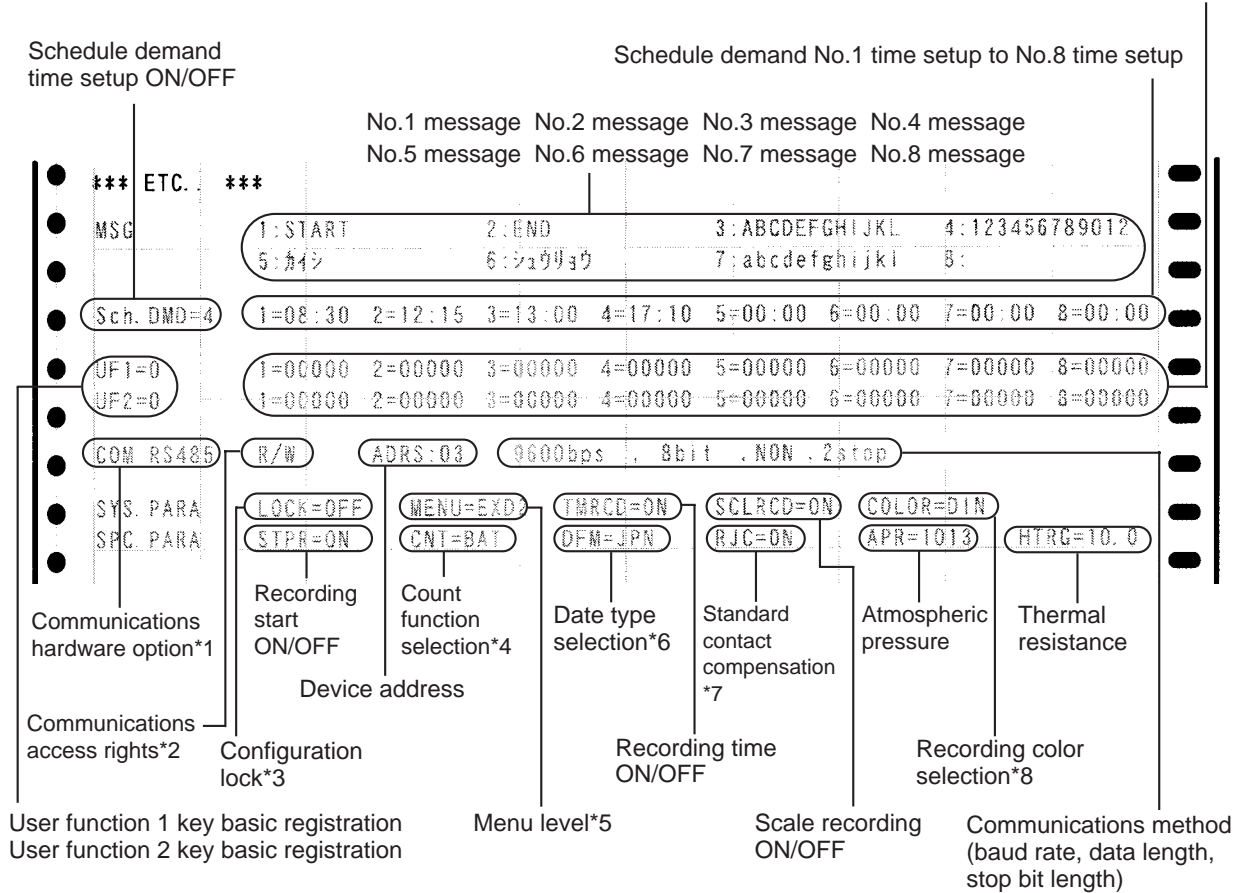

- \*1: This is not a setup item.
- \*2: Communications access rights  
RD: Read only  
R/W: Read/write
- \*3: Configuration lock  
OFF: Unlocked  
ON: Locked
- \*4: Count function selection  
BAT: Batch count  
BIN: Binary count
- \*5: Menu level  
STD: Display only level 0 items.  
EXD1: Display level 0 and 1 items.  
EXD2: Display all setup items.
- \*6: Date type selection  
JPN: JP (YY, MM, DD)  
ENG: US (MM, DD, YY)  
EC: EU (DD, MM, YY)
- \*7: Standard contact compensation  
ON: Located internally  
OFF: Located externally
- \*8: Recording color selection  
STD: STD (purple, red, green, blue, brown, black)  
DIN: DIN (purple, red, black, green, blue, brown)

● Example of print all lists (segment table) details

	X-axis		Y-axis		TABLE 2		TABLE 3		
*** TABLE ***	TABLE 1		TABLE 2		TABLE 3		TABLE 3		
	X (%)	Y (%)	X (%)	Y (%)	X (%)	Y (%)	X (%)	Y (%)	
1:	0.00	0.00	0.00	0.00	0.00	0.00	0.00	0.00	
2:	100.00	100.00	100.00	100.00	100.00	100.00	100.00	100.00	
3:	100.00	100.00	100.00	100.00	100.00	100.00	100.00	100.00	
4:	100.00	100.00	100.00	100.00	100.00	100.00	100.00	100.00	
5:	100.00	100.00	100.00	100.00	100.00	100.00	100.00	100.00	point 01
6:	100.00	100.00	100.00	100.00	100.00	100.00	100.00	100.00	⋮
7:	100.00	100.00	100.00	100.00	100.00	100.00	100.00	100.00	⋮
8:	100.00	100.00	100.00	100.00	100.00	100.00	100.00	100.00	⋮
9:	100.00	100.00	100.00	100.00	100.00	100.00	100.00	100.00	⋮
10:	100.00	100.00	100.00	100.00	100.00	100.00	100.00	100.00	⋮
11:	100.00	100.00	100.00	100.00	100.00	100.00	100.00	100.00	⋮
12:	100.00	100.00	100.00	100.00	100.00	100.00	100.00	100.00	⋮
13:	100.00	100.00	100.00	100.00	100.00	100.00	100.00	100.00	⋮
14:	100.00	100.00	100.00	100.00	100.00	100.00	100.00	100.00	⋮
15:	100.00	100.00	100.00	100.00	100.00	100.00	100.00	100.00	point 15

Segment table 1
Segment table 2
Segment table 3

# Chapter 6. DETAILED CONFIGURATION

## 6 - 1 Introduction

This chapter describes how to setup configuration items that are initially set on the SRF206/212/224.

Before you can change configuration settings, the configuration lock must be canceled. For details on how to cancel the configuration lock, see **Canceling Configuration Lock** (page 5-4).

This menu has three menu levels 0, 1 and 2.

Menu level 0 is for setting up event setting, event types, chart feed speed, date/time and other items, and is for carrying out list printing.

Menu level 1 is for setting up range types, recording scales, recording format, event differential, and other system settings.

Menu level 2 is for setting up all configuration setup items.

### ! Handling Precautions

Configuration can be setup also during recording. However, if the range type or other setup items are changed, display and recording sometimes becomes temporarily abnormal.

### 📖 Note

For details on event setting values, date/time setup and list printing to be configured in menu level 1, see **Chapter 5. BASIC CONFIGURATION**.

### ● Display Configuration

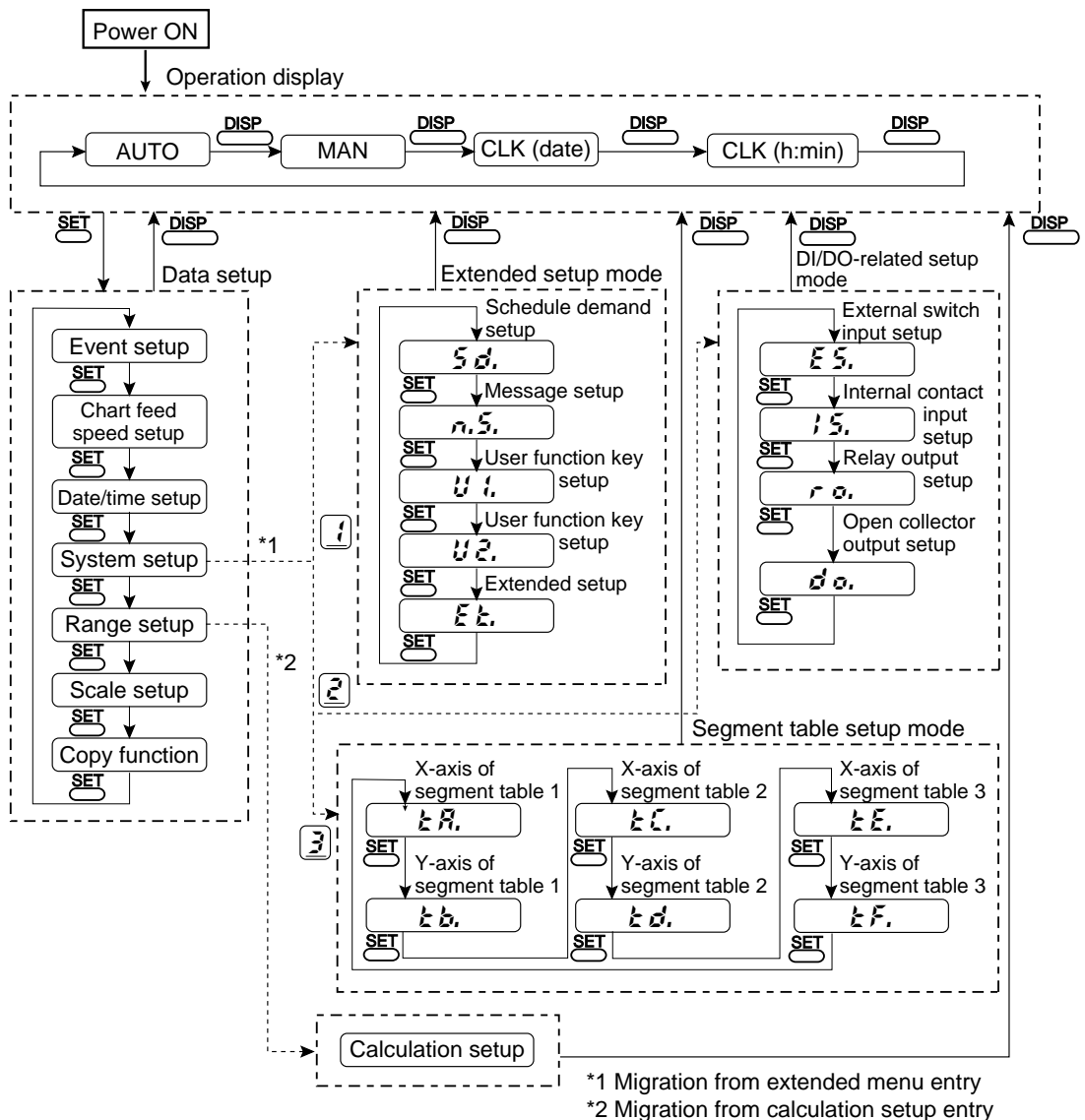

## 6 - 2 Configuration Data and Factory Settings

### Note

The setup items that can be changed varies according to the menu level. For details see page 6-1.

### ■ Event Setup (individual channels): EVNT

Display No.	Setup Item	Setup Description	Menu Level	Factory Setting
1	No.1 event setting value	-19999 to +29999	0	0
2	No.2 event setting value	-19999 to +29999	0	0
3	No.3 event setting value	-19999 to +29999	0	0
4	No.4 event setting value	-19999 to +29999	0	0
5	No.1 event type selection	- (OFF)/L (LOW)/H (HIGH)	0	- (OFF)
6	No.2 event type selection	- (OFF)/L (LOW)/H (HIGH)	0	- (OFF)
7	No.3 event type selection	- (OFF)/L (LOW)/H (HIGH)	0	- (OFF)
8	No.4 event type selection	- (OFF)/L (LOW)/H (HIGH)	0	- (OFF)
5	No.1 event output destination	0 to 36	0	0
6	No.2 event output destination	0 to 36	0	0
7	No.3 event output destination	0 to 36	0	0
8	No.4 event output destination	0 to 36	0	0
5	No.1 event recording ON/OFF	0 (OFF)/1 (ON)	0	1 (ON)
6	No.2 event recording ON/OFF	0 (OFF)/1 (ON)	0	1 (ON)
7	No.3 event recording ON/OFF	0 (OFF)/1 (ON)	0	1 (ON)
8	No.4 event recording ON/OFF	0 (OFF)/1 (ON)	0	1 (ON)
9	No.1 event differential	0 to 29999	1	0
A	No.2 event differential	0 to 29999	1	0
b	No.3 event differential	0 to 29999	1	0
c	No.4 event differential	0 to 29999	1	0

### ■ Chart Feed Speed Setup: SPD

Display No.	Setup Item	Setup Description	Menu Level	Factory Setting
1	No.1 chart feed speed	1 to 480mm/h	0	20
2	No.2 chart feed speed	1 to 480mm/h	1	20
3	Fixed date interval timer	1: 10min 2: 20min 3: 30min 4: 1h 5: 2h 6: 3h 7: 6h 8: 12h 9: 24h	1	1
4	Fixed time interval timer	00:05 to 23:59	1	00:30

### ■ Date/Time Setup: CLK

Setup Item	Setup Description	Menu Level	Factory Setting
Date	00/01/01 to 99/12/31	0	Close to Japan standard time
Time	00:00 to 23:59	0	Close to Japan standard time



## ■ System Setup: SYS

Display No.	Setup Item	Setup Description	Menu Level	Factory Setting
1	Configuration lock	0 (OFF)/1 (ON)	0	0 (OFF)
2	List printing start/stop	0: Stop list printing 1: Start specified list printing 2: Start range/scale settings printing 3: Start event and DI/DO settings printing 4: Start MSG, S.DMD, UF and communications settings printing 5: Start segment table settings printing 6: Start all list printing 7: Start communications list printing	0	0 (stop)
3	Menu level	0 to 2	0	0
4	Recording format	1: Trend 2: Trend + tabulation 3: Trend + schedule demand 4: Fixed interval tabulation (tabulation only) 5: Fixed time tabulation (tabulation only)	1	2
5	Recorder ID No.	0 to 99	1	0
6	Recording time ON/OFF	0 (OFF)/1 (ON)	1	1 (ON)
7	Scale recording ON/OFF	0 (OFF)/1 (ON)	1	1 (ON)
8	Recording color selection (STD/DIN)	1 (STD)/2 (DIN)	1	1 (STD)
9	Communications access rights	1 (read)/2 (read/write)	1	1 (read)
A	Device address	0 to 127 (setting to "0" inhibits communications)	1	0
b	Communications method	1: 4800bps, 8bits, even parity, 1 stop bit 2: 4800bps, 8bits, no parity, 2 stop bits 3: 9600bps, 8bits, even parity, 1 stop bit 4: 9600bps, 8bits, no parity, 2 stop bits	1	1
c	Extended menu entry	0: Migration disabled 1: Migration to extended setup mode 2: Migration to DI/DO-related setup mode 3: Migration to segment table setup mode	2	0

■ Range Setup (individual channels): RNG

Display No.	Setup Item	Setup Description	Menu Level	Factory Setting
1	Recording mode	0 (OFF)/ 1 (display)/ 2 (display + recording)/ 3 (digital input-dependent)	1	2 (display + recording)
2	Range code	See Range Code Table (page 6-47).	1	05 (±5V)
3	Digital signal No.	0 to 62	1	0
4	Burnout	0 (OFF)/ 1 (UP)/ 2 (DOWN)	1	0 (OFF)
5	Measurement range lower limit	-19999 to measurement range upper limit -1	1	1.000
6	Measurement range upper limit	Measurement range lower limit + 1 to 29999	1	5.000
7	Engineering range decimal point	0 (xxxxx) to 4 (x.xxxx)	1	1 (xxxx.x)
8	Engineering range lower limit	-19999 to +29999	1	0.0
9	Engineering range upper limit	-19999 to +29999	1	100.0
A	PV filter	0 to 15	1	0
b	PV bias	-19999 to +29999	1	0.0
c	Engineering unit	6 characters	1	Blank
d	Tag	12 characters	1	CH1 to 24 (shift to right)
E	Calculation setup entry	0: Entry to calculation setup disabled 1: Entry to calculation setup enabled	2	0

■ Calculation Setup (individual channels): RNG

Display No.	Setup Item	Setup Description	Menu Level	Factory Setting
1.	Input calculation type	0: OFF (PV value) 1: A channel - B channel 2: Fixed value - current channel 3: Current channel - fixed value 4: Integrating calculation 5: F value calculation 6: Relative humidity calculation	2	0
2.	Calculation parameter 1	Conditions	Setup description	
		Input calculation type = 1	1 to number of channels	Current channel
		Input calculation type = 2	-19999 to +29999	0.0
		Input calculation type = 3	-19999 to +29999	0.0
		Input calculation type = 4	0: s 1: min 2: h	0
		Input calculation type = 5	0.0 to 500.0	121.1
		Input calculation type = 6	1 to number of channels	*
3.	Calculation parameter 2	Input calculation type = 1	1 to number of channels	Current channel
		Input calculation type = 4	1 to 6	1
		Input calculation type = 5	1 to 6	1
		Input calculation type = 6	0: Large (2.5m/s or more) 1: Medium (0.5 to 2.5m/s) 2: Small (less than 0.5m/s)	0
4.	Calculation parameter 3	0 to 10	2	0
5.	Segment table use	0: Use disabled 1: Use segment table 1 2: Use segment table 2 3: Use segment table 3	2	0

\* : In channel 1 setup, this factory setting becomes “channel 2”. In other instances, this factory setting becomes “current channel -1”.

### ■ Scale Setup (individual channels): SCL

Display No.	Setup Item	Setup Description	Menu Level	Factory Setting
1	No.1 scale lower limit	-19999 to +29999 or 0.0 to 98.0*1	1	0.0
2	No.1 scale upper limit	-19999 to +29999	1	100.0
3	Scale switching method selection	0: OFF 1: Automatic 2: Internal contact input, external switch input or CPL communications	1	0
4	No.2 scale lower limit	-19999 to +29999 or 0.0 to 98.0*1	1	0.0
5	No.2 scale upper limit	-19999 to +29999	1	100.0
6	Auto-switching point	-19999 to +29999	1	0.0
7	Auto-switching differential	0 to 29999	1	0.0

\*1 At ON/OFF input range

### ■ Copy Function: COPY

Display No.	Setup Item	Setup Description	Menu Level	Factory Setting
1	Copy source channel	1 to number of channels	2	1
2	Copy destination channel lower limit	1 to copy destination channel upper limit	2	1
3	Copy destination channel upper limit	Copy destination channel lower limit to number of channels	2	Maximum channel
4	Copy execution	0: Execution OFF/end copy 1: Copy all data 2: Copy range, calculation and scale data 3: Copy event data 4: Copy tag data 5: Copy engineering unit data	2	0

### ■ Schedule Demand: SYS + 5 d.

Display No.	Setup Item	Setup Description	Menu Level	Factory Setting
1	Time setup ON/OFF	0: Time setup disabled (schedule demand printing is not carried out) 1: No.1 time setup enabled 2: No.1 and 2 time setup enabled 3: No.1 to 3 time setup enabled 4: No.1 to 4 time setup enabled 5: No.1 to 5 time setup enabled 6: No.1 to 6 time setup enabled 7: No.1 to 7 time setup enabled 8: No.1 to 8 time setup enabled	2	0
2	No.1 time setup	00:00 to 23:59	2	00:00
3	No.2 time setup			
4	No.3 time setup			
5	No.4 time setup			
6	No.5 time setup			
7	No.6 time setup			
8	No.7 time setup			
9	No.8 time setup			

---

**■ Message Setup: SYS + n. 5.**

Display No.	Setup Item	Setup Description	Menu Level	Factory Setting
1	No.1 message	12 characters	2	"MSG1"
2	No.2 message			"MSG2"
3	No.3 message			"MSG3"
4	No.4 message			"MSG4"
5	No.5 message			"MSG5"
6	No.6 message			"MSG6"
7	No.7 message			"MSG7"
8	No.8 message			"MSG8"

### ■ User Function Key Setup: SYS + U 1/U 2.

Channel No.	Display No.	Setup Item	Setup Description	Menu Level	Factory Setting
U 1.	1	User function 1 key basic registration	0: OFF 1: Output to internal contact input No.1 2: Call up setup items	2	0
	2	User function 1 assignment 1	0 to 32500 When UF1 key basic registration is set to 2: Sets a value obtained by adding the following cardinal number to the setup No. of the settings to be registered. "0" means that nothing is assigned. Setup Item            Cardinal Number Event ..... 1nn00 Chart feed speed ..... 1000 Date/time ..... 1500 System ..... 2000 Range ..... 2nn00 (Calculation setup is range setup + 5000.) Scale ..... 3nn00 Copy ..... 6500 Schedule demand ..... 2500 Message ..... 3000 Extended ..... 3500 External switch input .... 4000 Internal contact input ... 4100 Relay output ..... 4200 Open collector output ... 4300 Segment 1 X-axis ..... 5000 Segment 1 Y-axis ..... 5100 Segment 2 X-axis ..... 5200 Segment 2 Y-axis ..... 5300 Segment 3 X-axis ..... 5400 Segment 3 Y-axis ..... 5500 Item "nn" indicates the channel No. If the number is an alphabet character (hex), use a value after converting to a decimal number.	2	0
	3	User function 1 assignment 2			0
	4	User function 1 assignment 3			0
	5	User function 1 assignment 4			0
	6	User function 1 assignment 5			0
	7	User function 1 assignment 6			0
	8	User function 1 assignment 7			0
	9	User function 1 assignment 8			0
U 2.	1	User function 2 key basic registration			0: OFF 1: Output to internal contact input No.2 2: Call up setup items
	2	User function 2 assignment 1	Same as user function 1	2	0
	3	User function 2 assignment 2			0
	4	User function 2 assignment 3			0
	5	User function 2 assignment 4			0
	6	User function 2 assignment 5			0
	7	User function 2 assignment 6			0
	8	User function 2 assignment 7			0
	9	User function 2 assignment 8			0

---

**■ Extended Setup: SYS +  $\xi$   $\zeta$ .**

Display No.	Setup Item	Setup Description	Menu Level	Factory Setting
1	Initial printing ON/OFF	0: OFF 1: ON	2	1
2	Count function switching	0: Batch count 1: BIN code	2	0
3	Date type selection	0: JP (YY, MM, DD) 1: US (MM, DD, YY) 2: EU (DD, MM, YY)	2	0
4	Atmosphere	670 to 1330hPa	2	1013
5	Thermal resistance	1.0 to 20.0	2	10.0
6	Reference contact compensation	0: Internally OFF 1: Internally ON	2	1

### ■ External Switch Input Setup: ST + 5./Internal Contact Input Setup: ST + 5.

Display No.	Setup Item	Setup Description	Menu Level	Factory Setting	
				External switch input	Internal contact input
1	No.1 external switch input No.1 internal contact input	0: Function setup OFF 1: Recording ON/OFF (all channels unconditionally)	2	1	0
2	No.2 external switch input No.2 internal contact input	2: Print on demand 3: Print all lists 4: Print specified lists		2	0
3	No.3 external switch input No.3 internal contact input	5: Chart feed 6: Print communications list 7: Chart feed speed/scale selection		5	0
4	No.4 external switch input No.4 internal contact input	8: Clear batch counter 11: Clear integrating calculation 1 12: Clear integrating calculation 2		21	0
5	No.5 external switch input No.5 internal contact input	13: Clear integrating calculation 3 14: Clear integrating calculation 4 15: Clear integrating calculation 5		0	0
6	No.6 external switch input No.6 internal contact input	16: Clear integrating calculation 6 21: Print No.1 message 22: Print No.2 message		0	0
7	No.7 external switch input No.7 internal contact input	23: Print No.3 message 24: Print No.4 message 25: Print No.5 message		0	0
8	No.8 external switch input No.8 internal contact input	26: Print No.6 message 27: Print No.7 message 28: Print No.8 message		0	0
9	No.9 external switch input No.9 internal contact input	31: Recording ON/OFF (channels 1 to 3) 32: Recording ON/OFF (channels 4 to 6) 33: Recording ON/OFF (channels 7 to 9)		0	0
A	No.10 external switch input No.10 internal contact input	34: Recording ON/OFF (channels 10 to 12) 35: Recording ON/OFF (channels 13 to 18) 36: Recording ON/OFF (channels 19 to 24)		0	0
B	No.11 external switch input No.11 internal contact input	40: BIN code input 2 <sup>0</sup> (+1) 41: BIN code input 2 <sup>1</sup> (+2) 42: BIN code input 2 <sup>2</sup> (+4)		0	0
C	No.12 external switch input No.12 internal contact input	43: BIN code input 2 <sup>3</sup> (+8) 44: BIN code input 2 <sup>4</sup> (+16) 45: BIN code input 2 <sup>5</sup> (+32)		0	0

### ■ Relay Output Setup: SYS + r 0./Open Collector Output Setup: SYS + d 0.

Display No.	Setup Item	Setup Description	Menu Level	Factory Setting
1	No.1 relay/open collector output	0: OR action/excitation/non-hold	2	0
2	No.2 relay/open collector output	1: OR action/excitation/hold		
3	No.3 relay/open collector output	2: OR action/non-excitation/non-hold		
4	No.4 relay/open collector output	3: OR action/non-excitation/hold		
5	No.5 relay/open collector output	4: AND action/excitation/non-hold		
6	No.6 relay/open collector output	5: AND action/excitation/hold		
7	No.7 relay/open collector output	6: AND action/non-excitation/non-hold		
8	No.8 relay/open collector output	7: AND action/non-excitation/hold		
9	No.9 relay/open collector output	8: OR action/excitation/non-hold/event re-output		
A	No.10 relay/open collector output	9: OR action/non-excitation/non-hold/event re-output		
B	No.11 relay/open collector output			
C	No.12 relay/open collector output			

■ **Segment Table 1 Setup: SYS + ㄱ ㄱ., ㄱ ㄴ.**

Channel No.	Display No.	Setup Item	Setup Description	Menu Level	Factory Setting
ㄱ ㄱ.	1	Segment table 1 X-axis point 01	-10.00 to +110.00%	2	0.00
	2	Segment table 1 X-axis point 02			100.00
	3	Segment table 1 X-axis point 03			100.00
	4	Segment table 1 X-axis point 04			100.00
	5	Segment table 1 X-axis point 05			100.00
	6	Segment table 1 X-axis point 06			100.00
	7	Segment table 1 X-axis point 07			100.00
	8	Segment table 1 X-axis point 08			100.00
	9	Segment table 1 X-axis point 09			100.00
	ㄱ	Segment table 1 X-axis point 10			100.00
	ㄴ	Segment table 1 X-axis point 11			100.00
	ㄷ	Segment table 1 X-axis point 12			100.00
	ㄹ	Segment table 1 X-axis point 13			100.00
	ㅁ	Segment table 1 X-axis point 14			100.00
	ㅂ	Segment table 1 X-axis point 15			100.00
ㄱ ㄴ.	1	Segment table 1 Y-axis point 01	-10.00 to +110.00%	2	0.00
	2	Segment table 1 Y-axis point 02			100.00
	3	Segment table 1 Y-axis point 03			100.00
	4	Segment table 1 Y-axis point 04			100.00
	5	Segment table 1 Y-axis point 05			100.00
	6	Segment table 1 Y-axis point 06			100.00
	7	Segment table 1 Y-axis point 07			100.00
	8	Segment table 1 Y-axis point 08			100.00
	9	Segment table 1 Y-axis point 09			100.00
	ㄱ	Segment table 1 Y-axis point 10			100.00
	ㄴ	Segment table 1 Y-axis point 11			100.00
	ㄷ	Segment table 1 Y-axis point 12			100.00
	ㄹ	Segment table 1 Y-axis point 13			100.00
	ㅁ	Segment table 1 Y-axis point 14			100.00
	ㅂ	Segment table 1 Y-axis point 15			100.00

■ **Segment Table 2 Setup: SYS + ㄱ ㄷ., ㄱ ㄹ.**

The setup method is the same as for the setup details described for segment table 1.

■ **Segment Table 3 Setup: SYS + ㄱ ㅁ., ㄱ ㅂ.**

The setup method is the same as for the setup details described for segment table 1.



## 6 - 3 Event Setup

### ■ Event Setup

The event differential can be set only in menu level 1. However note that the event setting value can be changed in menu level 0, too.

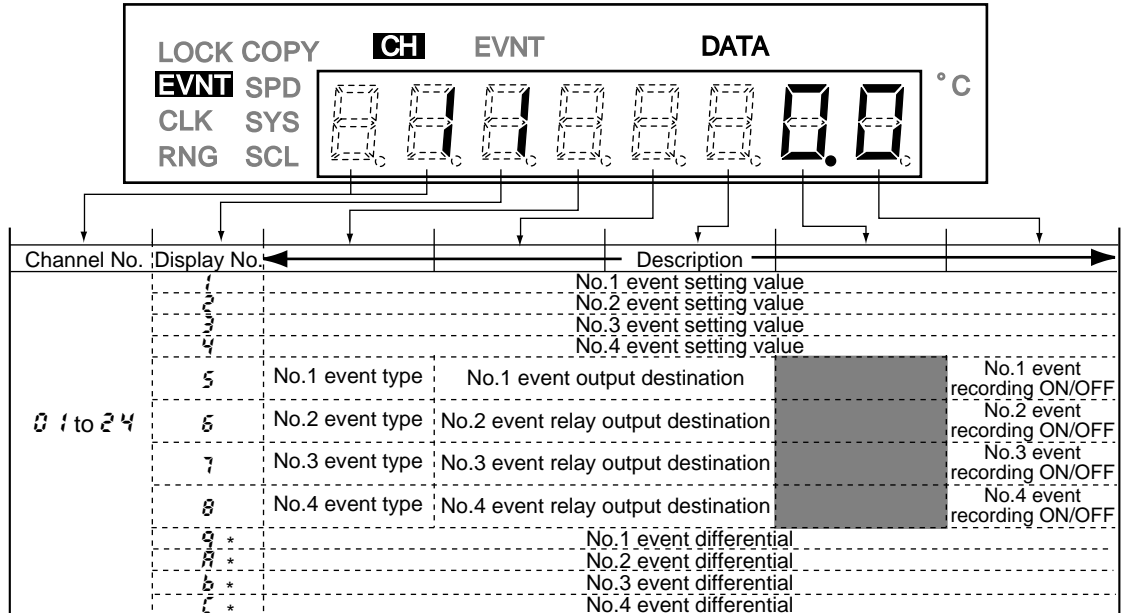

**Note**

\*: These are displayed when menu level 1 is selected.

Event setting values are not displayed when the event type is set to “-----” (event OFF).

◇ Setup Details ◇

Event setting value : “-19999 to +29999” (U)

Event type : “-----” no event  
 “H” upper limit  
 “L” lower limit

Event relay output destination

: “0” no output destination  
 : “1 to 12” correspond to the Nos.1 to 12 relay outputs  
 : “13 to 24” correspond to the Nos.1 to 12 open collector outputs  
 : “25 to 36” correspond to the Nos.1 to 12 internal contact inputs

Event recording ON/OFF : “0” event recording OFF

: “1” event recording ON

Event differential : “0 to 29999” (U)

## ■ Description of Event Setup Items

### ● Event type and differential

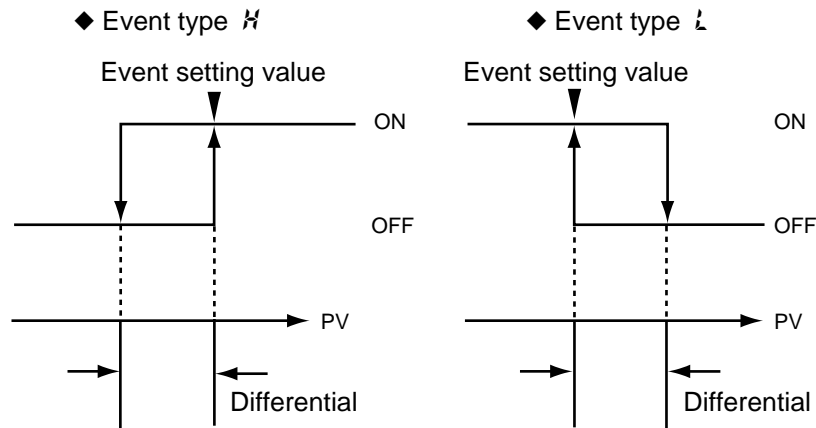

### ● Event output destination

When the event output destination is set to “0”, output is not carried out to any of the relay outputs, open collector outputs, and internal contact inputs.

Up to four event setups can be set to each channel. You can specify the same relay output, open collector output and internal contact input in multiple event setups. However, in this case, outputs that are used in duplicate are dependent on the respective output setup.

For details on relay output, see “**6-16 Relay Output Setup** (page 6-40),” open collector output, “**6-17 Open Collector Output Setup** (page 6-43),” and internal contact input, “**6-15 External Switch Input/Internal Contact Input Setup** (page 6-37)”.

### ● Event recording ON/OFF

When event recording is set to OFF, neither event occurrence nor restoration are recorded.

### ● Event buffer

Up to 24 events including occurrence and restorations can be buffered (stored in memory). Events exceeding this figure are not buffered. If events occur or are restored beyond this figure, a “\*” mark is inserted between the channel No. and h:min in the list print of the 24th buffered event.

#### ! Handling Precautions

Events are buffered only at recording. Event outputs are not buffered.

### ● Relay excitation direction and contact

When an event occurs, the relay is excited according to the specified relay output setting. The contact is transfer contact output (both NO and NC contacts are output by SPDT output).

### ● Event measurement cycle

This is the same as the input measurement cycle.

#### ! Handling Precautions

Recording is sometimes performed in order “H” and “L” according to the measurement sequence.

# 6 - 4 Chart Feed Speed Setup

## ■ Chart Feed Speed Setup

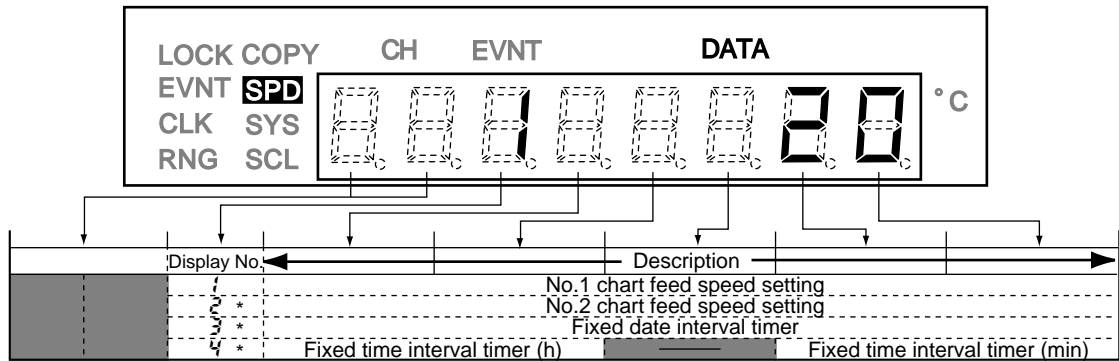

**Note**

\*: These are displayed when menu level 1 is selected.

◇ Setup Details ◇

- No.1 chart feed speed : 1 to 480mm/h, settable in 1mm/h increments.
- No.2 chart feed speed : 1 to 480mm/h, settable in 1mm/h increments.
- Fixed interval timer : The printing interval for fixed interval tabulation recording can be set.

Setting Value	Tabulation Printing Cycle	Printing Time
1	Every 10min	00:00, 00:10, 00:20, . . . .23:50
2	Every 20min	00:00, 00:20, 00:40, . . . .23:40
3	Every 30min	00:00, 00:30, 01:00, . . . .23:30
4	Every h	00:00, 01:00, 02:00, . . . .23:00
5	Every 2h	00:00, 02:00, 04:00, . . . .22:00
6	Every 3h	00:00, 03:00, 06:00, . . . .21:00
7	Every 6h	00:00, 06:00, 12:00, 18:00
8	Every 12h	00:00, 12:00
9	Every 24h	00:00

- Fixed time interval timer : 00:05 to 23:59  
The printing interval for fixed time tabulation recording can be set in 1min increments.

■ Description of Chart Feed Speed Setup Items

● Switching of chart feed speed

The chart feed speed can be switched at the same time as scale switching by external switch inputs or internal contact inputs.

For example, when the scale is switched by external switch inputs, the chart feed speed changes from the No.1 setting to the No.2 setting when the external switch changes from an open to a closed state.

● Chart feed speed and printing cycle

The time standard for the tabulation printing cycle when the recording format is set to “trend + tabulation” is “00:00”. The tabulation cycles are as shown in the table below.

If, for example, the chart feed speed is 20mm/h, then the tabulation time becomes 00:00, 04:00 and so forth up to 20:00.

To carry out tabulation printing at a specific time, select “trend + schedule demand” printing as the recording format.

Chart Feed Speed (mm/h)	“Trend + Tabulation” Tabulation Printing Cycle (printing time)
1 to 4	Printing OFF
5 to 10	Every 12h (0:00, 12:00)
11 to 20	Every 4h (0:00, 4:00, 8:00, and so forth)
21 to 40	Every 2h (odd h)
41 to 120	Every h (n:00)
121 to 480	Printing OFF

● Chart feed speed and date printing

Chart feed speed and date are printed alternately.

 Note

Chart Feed Speed and Character Size  
 Characters are printed in a 7-dot (vertical) x 5-dot (horizontal) matrix. Their height varies as follows, according to the chart feed speed. When the chart is fed at a fast speed, characters become longer and are difficult to distinguish. However, they become easier to distinguish if they are viewed at an angle from the bottom of the chart.

 Handling Precautions

Characters are not printed when the chart feed speed is 4mm/h or less and 121mm/h or more.

Character sizes (dimension between dot centers) for 6- and 12-dot models (numbers in parentheses are for 24-dot models)

Chart Feed Speed (mm/h)	1 to 4	5 to 40	41 to 60	61 to 80	81 to 100	101 to 120	121 to 480
Character Height (mm)	Printing	2.5	3.5	3.5 (4.5)	3.5 (5.5)	3.5 (6.5)	Printing
Vertical Pitch (mm)	OFF	3.5	5.0	5.0 (6.0)	5.0 (7.0)	5.0 (8.0)	OFF

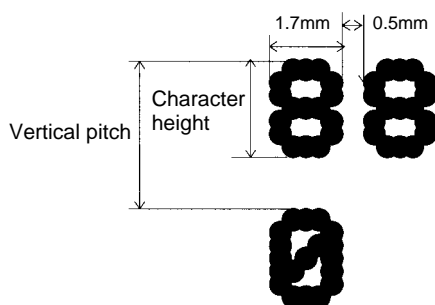

## 6 - 5 Date/Time Setup

### ■ Date/Time Setup

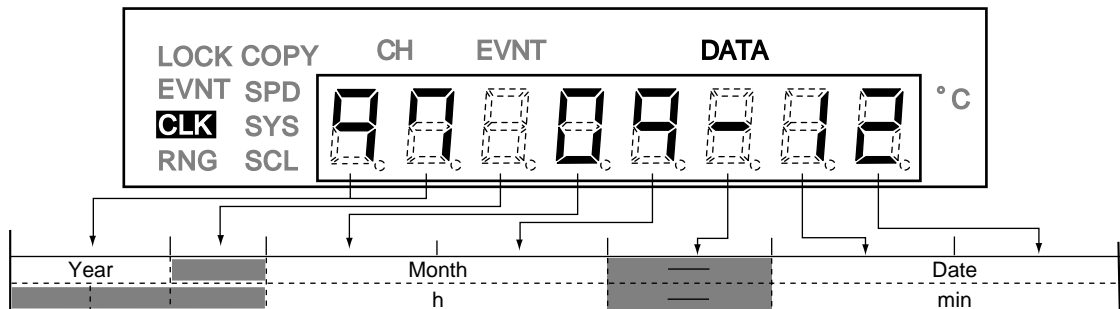

#### ! Handling Precautions

The number of seconds in the time setup are reset (so that counting starts from "00") when you press the **ENT** key, only when the numerical values for the time setup are changed. If you press the **ENT** key without making any changes to the numerical values for the time setup, the date setup display will be redisplayed, and the number of seconds will not be reset.

#### ◇ Setup Details ◇

Year : "90 to 99" 1990 to 1999  
 "00 to 89" 2000 to 2089  
 Month : "01 to 12" January to December  
 Day : "01 to 31" 1st to 31st  
 Hour : "00 to 23" 0am to 11pm  
 Minute : "00 to 59" 0 to 59min

#### 📖 Note

- Clock accuracy is about  $\pm 50$ ppm or about 130s/month under standard conditions.
- The SRF206/212/224 automatically adjusts for leap years until 2089.

# 6 - 6 System Setup

## ■ System Setup

By system setup, you set the basic items for operating this recorder.

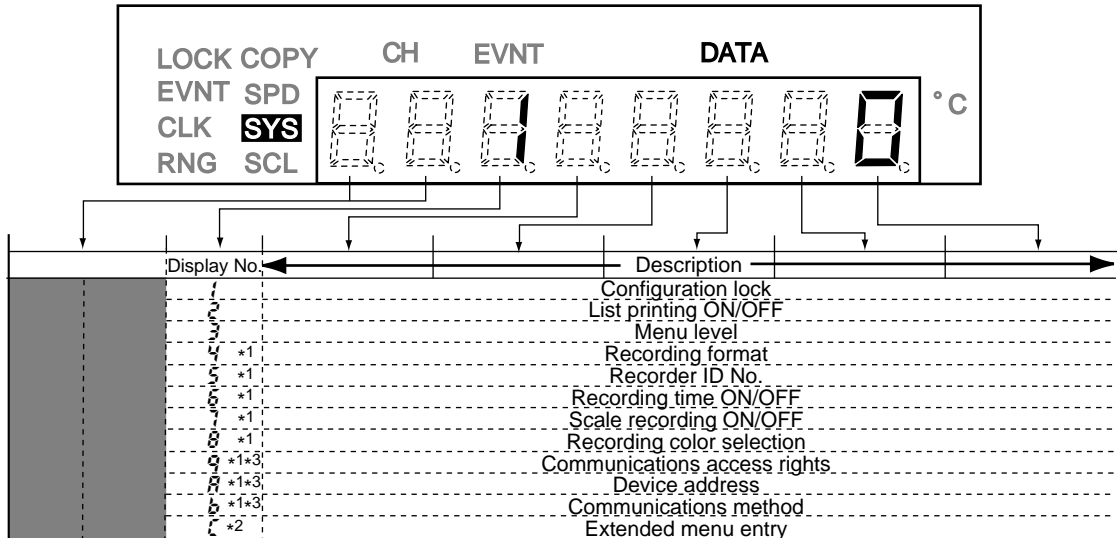

### Note

- \*1: These are displayed when menu level 1 is selected.
- \*2: These are displayed when menu level 2 is selected.
- \*3: These are not displayed on models that do not support the communications (optional) function.

### ◇ Setup Details ◇

- Configuration lock : “0” lock OFF  
“1” lock ON
- List printing start/stop : “0” stop printing of lists  
“1” start printing of specified lists  
“2” start printing of range and scale setups  
“3” start printing of events and DI/DO setups  
“4” start printing of messages, schedule demands, UF and communications setups  
“5” start printing of segment table setups  
“6” start printing of all lists  
“7” start printing of communications lists
- Menu level : “0” display only level 0 setup items  
“1” display level 0 and 1 setup items  
“2” display all setup items
- Recording format : “1” trend  
“2” trend + tabulation  
“3” trend + schedule demand  
“4” fixed interval tabulation (tabulation only)  
“5” fixed time tabulation (tabulation only)
- Recorder ID No. : “0 to 99” ID No. is not printed when set to “0”

---

Time recording ON/OFF	: “0” OFF (time is not recorded) “1” ON (time is recorded)
Scale recording ON/OFF	: “0” OFF (scale is not recorded) “1” ON (scale is recorded)
Recording color selection	: “1” STD (purple, red, green, blue, brown, black) “2” DIN (purple, red, black, green, blue, brown)
Communications access rights	: “1” read only “2” read/write
Device address	: “0 to 127” communications is inhibited when set to “0”.
Communications method	: “1” 4800bps, 8bits, even parity, 1 stop bit “2” 4800bps, 8bits, no parity, 2 stop bits “3” 9600bps, 8bits, even parity, 1 stop bit “4” 9600bps, 8bits, no parity, 2 stop bits
Extended menu entry	: “0” migration disabled “1” migration to extended setup mode “2” migration to DI/DO-related setup mode “3” migration to segment table setup mode

## ■ Description of System Setup Items

### ● Configuration lock

When the configuration lock is active, configurations can no longer be written from the SRF206/212/224's display setup. Setup details, however, can be checked.

Configurations can be written by CPL communications or from a personal computer loader even if the configuration lock is active.

### ● Details of specified list printing

- Date/time (h:min)/recording format/chart feed speed/recorder ID number
- Channel number/range type/recording scale/unit
- Event setup (setting value, type)

### ● How to use the recorder ID No.

When you are using two or more SRF206/212/224s, you can print individual recorder ID Nos. when printing is started to distinguish which recorder is being used to record on the chart.

### ● Time recording OFF

When time recording is set to OFF, no date/time information is printed on the chart. When importance is placed on knowing actual time, set time recording to ON (factory setting).

### ● Recording color selection

You can select from two types of color patterns. The DIN color pattern is provided mainly for use in Europe.



# 6 - 7 Range Setup

## Range Setup

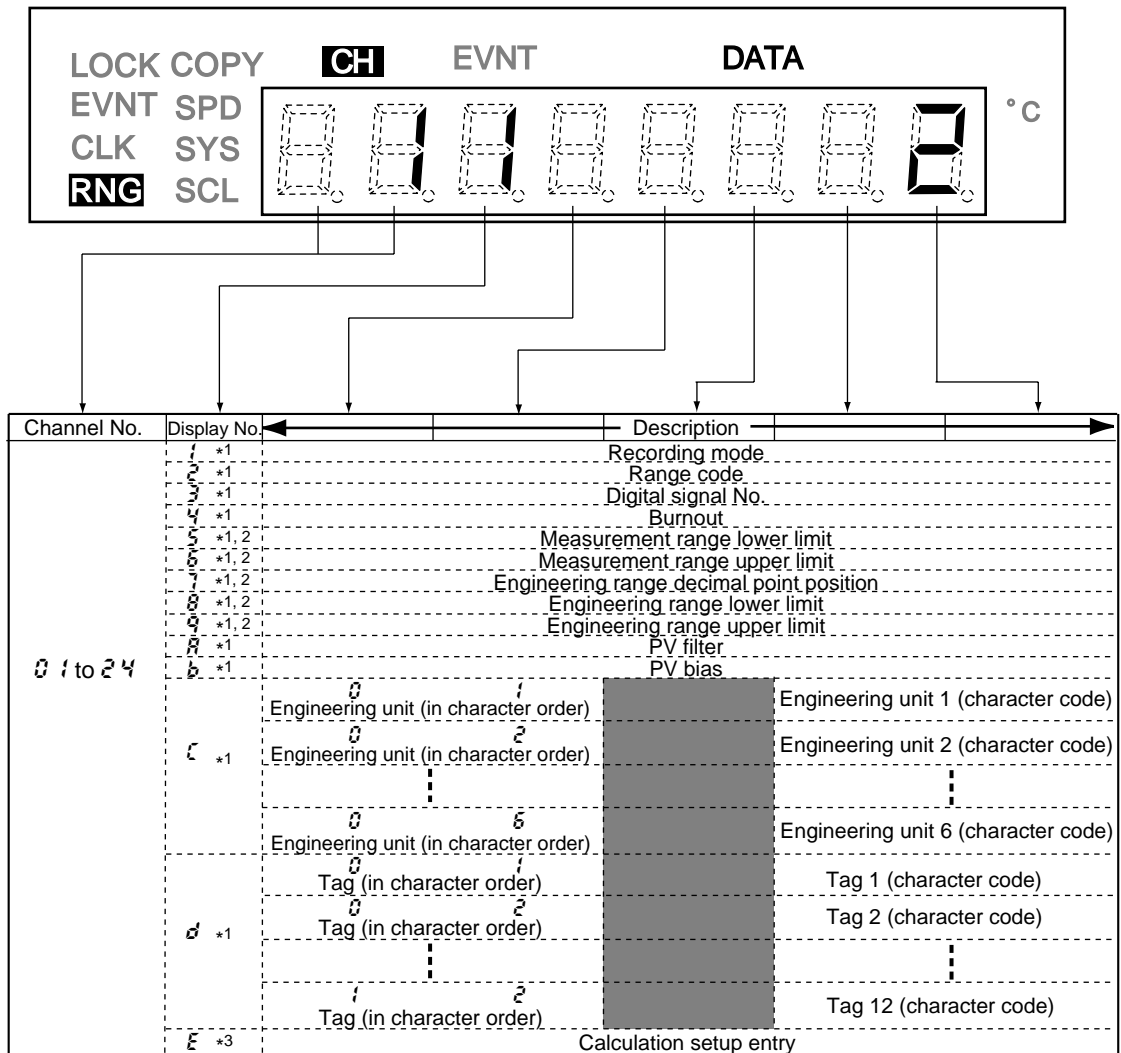

### Note

- \*1: These are displayed when menu level 1 or higher is set.
  - \*2: These are displayed when the input range code is set to 0 to 6.
  - \*3: This is displayed when menu level 2 is selected.
- Some setup items are not displayed depending on the range code setup.

### ◇ Setup Details ◇

- Recording mode : “0” display/recording OFF  
“1” display only  
“2” display + recording  
“3” digital input-dependent
- Range code : See **6-19 Range Code Table** (page 6-47)
- Digital signal No. : “0 to 62”

Sub Code No.	Digital Data Acquisition Destination
01 to 12	Relay output No.1 to No.12
13 to 24	Open collector output No.1 to No.12
31 to 42	External switch input No.1 to No.12
51 to 62	Internal contact input No.1 to No.12

Burnout	: “0” OFF “1” UP “2” DOWN
Measurement range lower limit	: “-19999 to measurement range upper limit -1” (U)
Measurement range upper limit	: “measurement range lower limit + 1 to 29999” (U)
Engineering range decimal point	: “0” xxxxx “1” xxxx.x “2” xxx.xx “3” xx.xxx “4” x.xxxx
Engineering range upper/lower limits	: “-19999 to +29999” (U)
PV filter	: “0 to 15”
PV bias	: “-19999 to +29999” (U)
Character order	: “1 to 6” 1st to 6th character Or, “1 to 12” 1st to 12th character
Engineering unit	: See <b>6-20 Character Code Table</b> (page 6-49) (Set by character code.)
Tag	: See <b>6-20 Character Code Table</b> (page 6-49) (Set by character code.)
Calculation setup entry	: “0” migration OFF “1” migration to calculation setup

## ■ How to Set the Engineering Unit

Set the engineering unit as follows:

- (1) Make the number for the character order you want to set blink using the ◀ or ▶ keys, and enter the character order using the ▲ or ▼ keys.
- (2) Make the number for the character code blink using the ◀ or ▶ keys, and set the character you want to enter as a character code using the ▲ or ▼ keys.
- (3) Repeat steps (1) and (2). When you have finished setting all characters, press the  key. The screen advances to the tag setup screen.

### Note

Set tags in the same way as you set the engineering unit.

## ■ Description of Range Setup Items

### ● Recording mode and operation

Recording Mode	Display	Recording	Event	Communications
“0” display/recording OFF	X	X	X	-32767 is returned
“1” display only	Operable	X	Operable	Operable
“2” display/recording ON	Operable	Operable	Operable	Operable
“3” digital input-dependent	X	X	X	-32767 is returned
	Operable	Operable	Operable	Operable

\* When DI is ON  
\* When DI is OFF

### Note

When digital input-dependent is selected, and recording ON/OFF is set for “31 to 36” by external switch input or internal contact input, display, recording and occurrence of events can be suppressed according to the state of the digital inputs.

### ● Range code selection

The SRF206/212/224 supports full multi-input. Merely selecting the range type here fixes the range code.

#### Handling Precautions

When the range code is changed, the configurations of the following items are initialized to their defaults:

- Digital signal
- Measurement range lower limit
- Measurement range upper limit
- Engineering range decimal point
- Engineering range lower limit
- Engineering range upper limit
- PV filter
- PV bias
- No.1 scale lower limit value
- No.1 scale upper limit value
- Scale switching method
- No.2 scale lower limit value
- No.2 scale upper limit value
- Auto-switching point
- Auto-switching differential

### ● Recording of digital signals

Digital signals are recording instead of analog signals by selecting “90” (ON/OFF type input range) as the range code, and assigning a digital data acquisition destination other than “0” as the digital signal No.

When an unmounted digital input is set as the acquisition destination, recording is performed with recording of digital signals fixed to OFF.

### ● Burnout

Input values are forced to a preset direction when the input signal becomes open during thermocouple input.

#### Handling Precautions

- When a thermocouple is shared with a device other than this recorder, the input signal sometimes interferes with the burnout detection circuit of the other device, preventing burnout from being detected correctly.  
If the circuit of this recorder connected to a single thermocouple has a large wiring resistance, the analog input values of the other device may adversely be affected. To prevent this from happening in such a connection, turn the burnout setting of this recorder to OFF.

### ● PV filter

The PV filter obtains the moving average of a suddenly changing PV to filter PV. The number of samples during moving averaging is “(PV filter setting value) + 1”. For this reason, PV filter function does not work when the PV setting value is 0.

● **PV bias**

“PV bias” refers to the PV offset value. This value is used in the following instances:

- On instrumentation incorporating a controller and a recorder, enter the PV bias when double-element RTDs or thermocouple inputs are used in parallel. PV bias functions to match the PV value indicated on the controller and the PV on the recorder.
- Enter the PV bias when the sensor is impaired or when measurement values are deviating. PV bias functions to compensate measurement values.

● **Position of engineering range decimal point and engineering range upper/lower limit values**

These ranges can be set only when the input range code is set to 0 to 6. These settings determine the display resolution of the measurement range. The resolution of trend recording is fixed to 0.1%FS regardless of these settings.

● **Reverse scaling**

You can reverse scaling of the engineering range by reversing the numerical values for the upper and lower limit values.

● **Measurement range and engineering range setup**

These ranges can be set only when the input range code is set to 0 to 6. (When other range codes are set, the setup mode is not migrated to.) PV is calculated by the following formula:

$$(PV) = \frac{(\text{engineering range upper limit value}) - (\text{engineering range lower limit value})}{(\text{measurement range upper limit value}) - (\text{measurement range lower limit value})} \times \{(\text{input value}) - (\text{measurement range lower limit value})\} + (\text{engineering range lower limit value}) + (PV \text{ bias})$$

The measurement range is assigned to the range of the DC voltage that is to be actually used.

[Setup Example 1]

Item	Input Value	Description
Range code setting	5	-5 to +5V
Measurement range upper value	5.000	
Measurement range lower value	1.000	When 0.0 to 2500.0kPa is assigned to the voltage input value of 1 to 5V.
Engineering range upper value	2500.0	
Engineering range lower value	0.0	
Engineering unit	kPa	

Indicated PV value when 2V is input = 625kPa

[Setup Example 2]

Item	Input Value	Description
Range code setting	5	-5 to +5V
Measurement range upper value	3.200	
Measurement range lower value	1.200	When 0.0 to 2500.0kPa is assigned to the voltage input value of 1.2 to 3.2V.
Engineering range upper value	2500.0	
Engineering range lower value	0.0	
PV bias	-1000.0	
Engineering unit	kPa	

Indicated PV value when 2V is input = 0kPa

## 6 - 8 Calculation Setup

### ■ Calculation Setup

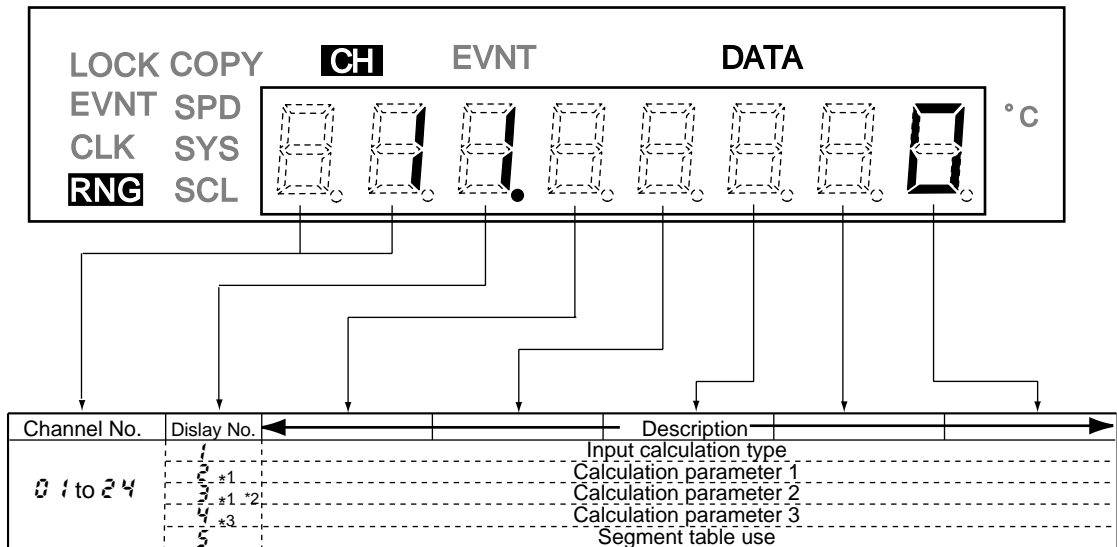

#### Note

- Calculation setup is displayed when the menu level is set to 2. To enter calculation setup, enter “1” at display No. “ $\text{E}$ ” in the range setup.
  - \*1: This is not displayed when the input calculation type is set to “0”.
  - \*2: This is not displayed when the input calculation type is set to “2” or “3”.
  - \*3: This is not displayed when the input calculation type is set to other than “4”.
- For details, see “6-22 Calculation Functions” (page 6-51).

#### ◇ Setup Details ◇

- Input calculation type : “0” OFF (PV value)
  - “1” A channel-B channel
  - “2” Fixed value-current channel
  - “3” Current channel-fixed value
  - “4” Integrating calculation
  - “5” F value calculation
  - “6” Relative humidity calculation
- Calculation parameter 1
  - When input type is “1”
    - A channel for deviation : “1 to max. channel”
  - When input type is “2” or “3”
    - Fixed value : “-19999 to +29999” (U)
  - When input type is “4”
    - Integration time unit : “0” s
    - “1” min
    - “2” h
  - When input type is “5”
    - Standard reference temperature : “0.0 to 500.0” (°C)
  - When input type is “6”
    - Dry bulb temperature input channel : “1 to max. channel”

- Calculation parameter 2
  - When input type is “1”
    - B channel for deviation : “1 to maximum channel”
  - When input type is “4” or “5”
    - Clear integrating calculation No. : “1” (clear integrating calculation 1)
    - “2” (clear integrating calculation 2)
    - “3” (clear integrating calculation 3)
    - “4” (clear integrating calculation 4)
    - “5” (clear integrating calculation 5)
    - “6” (clear integrating calculation 6)
  - When input type is “6”
    - Wind speed : “0” Large (2.5m/s or more)
    - “1” Medium (0.5m/s or more and less than 2.5m/s)
    - “2” Small (less than 0.5m/s)
- Calculation parameter 3 : “0 to 10” Integration weighting
- Segment table use : “0” Use disabled
  - “1” Use segment table 1
  - “2” Use segment table 2
  - “3” Use segment table 3

## ■ Description of Calculation Setups

### ● Input calculation type

- When “0” OFF (PV value) is selected, the analog input is displayed and recorded as it is.
- When “1” A channel-B channel is selected, the result obtained by calculating the difference between the analog input value of the channel specified in the next calculation parameter 1 and 2, respectively, is displayed and recorded as the PV.
- When difference calculation is selected for “2” and “3” fixed values, the result obtained by calculating the difference between the fixed value set in the next calculation parameter 1 and the analog input value is displayed and recorded as the PV.
- When “4” integrating calculation is selected, integration is performed using the integrating time unit specified in the next calculation parameter 1 and the integration weighting specified in calculation parameter 3, and the result is displayed and recorded as the PV.  
Integration is cleared by setting integration calculation clear by external switch input or internal contact input in calculation parameter 2.
- When “5” F value calculation is selected, calculation of the F value is performed together with the thermal resistance in “**6-14 Extended Setup**” (page 6-35). taking the next calculation parameter 1 as the standard reference temperature (°C), and the result is displayed and recorded as the PV.  
Integration is cleared by setting integration calculation clear by external switch input or internal contact input in calculation parameter 2.
- When “6” relative humidity calculation is selected, the relative humidity is calculated taking the analog input of the current channel as the wet bulb temperature and the channel specified by calculation parameter 1 as the dry bulb temperature.  
The wind speed required for relative humidity is set in calculation parameter 2, and the atmospheric pressure is set in “**6-14 Extended Setup**” (page 6-35).  
For details of these operations, see “**6-22 Calculation Functions**” (page 6-51).

- **Segment table**

Broken line approximation can be applied on analog inputs using a specified segment table.

For details on setting up segment tables, see “**6-18 Segment Table Setup**” (page 6-44).

For details, see “**6-22 Calculation Functions**” (page 6-51).

# 6 - 9 Scale Setup

## Scale Setup

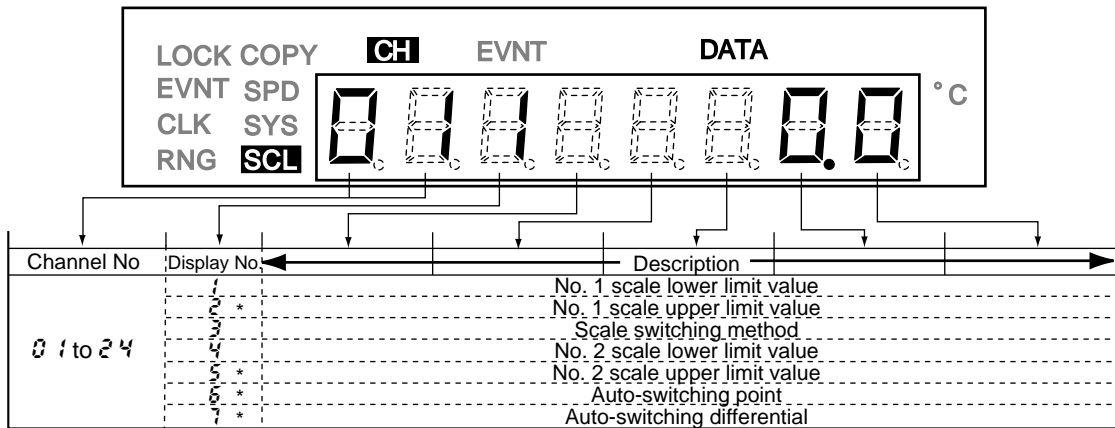

**Note**

The scale setup is displayed when menu level 1 or higher is set.  
 \*: These are skipped and not displayed in the case of the ON/OFF input range.

◇ Setup Details ◇

- Scale upper/lower limits : “-19999 to +29999” (U)  
 “0.0 to 98.0” (%)

**! Handling Precautions**

- When scale switching method is set to “0”, the No.2 scale upper and lower limits are skipped and not displayed.
- In the case of the ON/OFF input range, the setup range becomes “0.0 to 98.0”, and only the scale lower limit value can be set. This becomes the specified chart recording position when the input signal is OFF. When the input signal is ON, recording is performed at a position obtained by adding 2% to this setup.

- Scale switching method : “0” switching OFF  
 “1” auto-switching  
 “2” switching by external switch input/internal contact input/communications

**! Handling Precautions**

“1” (auto-switching) cannot be set in the case of the ON/OFF input range.

- Auto-switching point : “-19999 to +29999” (U)
- Auto-switching differential : “0 to +29999” (U)

**! Handling Precautions**

When the scale switching method is set to “0” or “2”, the auto-switching point and auto-switching differential are skipped and not displayed.



## ■ Description of Scale Setup Items

### ● Reverse scaling

You can reverse scaling of the No.1 and No.2 scales by reversing the numerical values for the upper and lower limit values.

### ● Auto-switching differential

The differential is set to provide a degree of margin so that the recording scale is not immediately restored to its original scale when auto-switching is set.

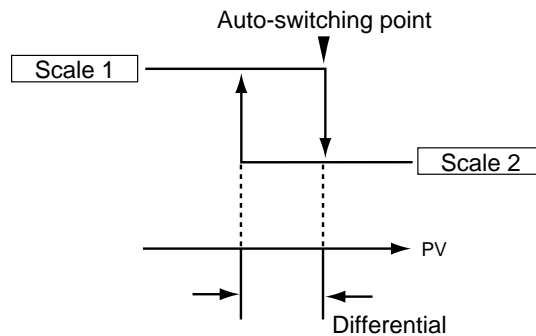

### ● Switching scale by external switch input or internal contact input

The scale can be switched according to the states of switches and switch inputs by selecting “2” (external switch input/internal contact input/communications) and “7” (chart feed speed/scale selection) as the scale switching method.

Switching at this time is performed using “No.1 scale and No.1 chart feed speed” and “No.2 scale and No.2 chart feed speed” as pairs.

### ● Minimum scaling range

Trend recording becomes stepped if scaling is set too narrow.

The resolution of trend recording in a 180mm recording width is 1/1800. Carry out scaling in such a way that this, or a higher resolution, can be obtained referring to the resolution item in the specifications.

### ● ON/OFF input range scale

The ON/OFF input range scale sets the dot position when the input signal is OFF by the scale lower limit value in scale setup steps 1 and 4.

When the scale is set to “30.0”, the dot is printed at the 30% position, when the input signal is OFF and at the 32% position when the input signal is ON.

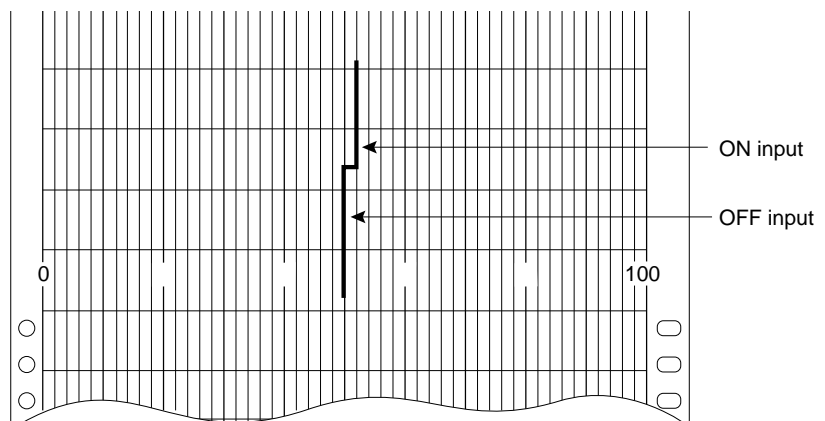

● Scale setup

The recording scale lower and upper limit values are set as the chart 0% and 100% positions. For example, the range is -200.0 to +1370.0°C (input range code: 23) in the case of a K thermocouple. However, to set the left side (0% position) of the chart as “0.0°C” and the right side (100% position) of the chart as “1000.0°C” when carrying out trend recording on the chart, set the scale lower limit value to “0.0” and the upper limit value to “1000.0”.

As the scale setup range is -19999 to +29999, this can be used to record specific zones. For example, in the above example, to write the trend of a K thermocouple on the right half of the chart, set the scale lower limit value to “-1000.0” and the upper limit value to “1000.0”.

Example: K thermocouple range code: 23 (-200.0 to +1370.0°C)

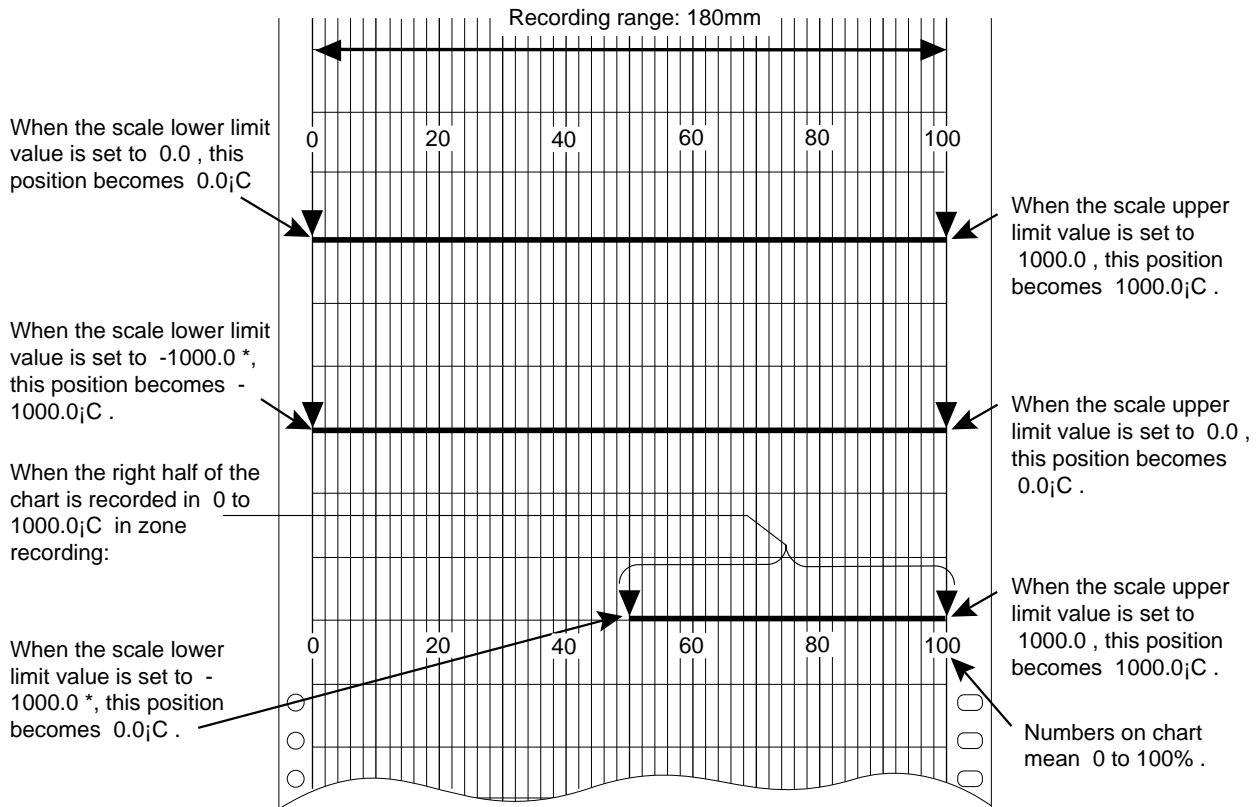

\*: In the linear scale range, the decimal point becomes the value set in the range setup item.

! Handling Precautions

The scale setup range is -1999.9 to +2999.9.

## 6 - 10 Copy Function

### ■ Copy Function

Configurations that must be set to each of the channels can be transferred between channels using the copy function.

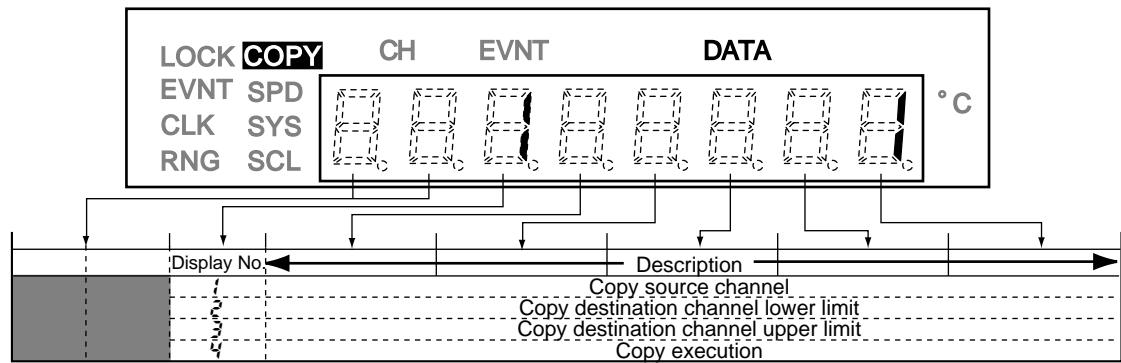

#### Note

This function is displayed only when menu level 2 is set.

#### ◇ Setup Details ◇

- Copy source channel : "1 to maximum channel"
- Copy destination channel lower limit : "1 to copy destination channel upper limit"
- Copy destination channel upper limit : "copy destination channel lower limit to number of channels"
- Copy execution : "0" execution OFF/end copy  
 "1" copy all data  
 "2" copy range, calculation and scale data  
 "3" copy event data  
 "4" copy tag data  
 "5" copy engineering unit data

# 6 - 11 Schedule Demand Setup

## ■ Schedule Demand Setup

The number of schedule demands and their times can be set.

Select 1 (migration to extended setup mode) at display No. "C" in the system setup screen.

Press the **SET** key until "S d." in the following figure is displayed:

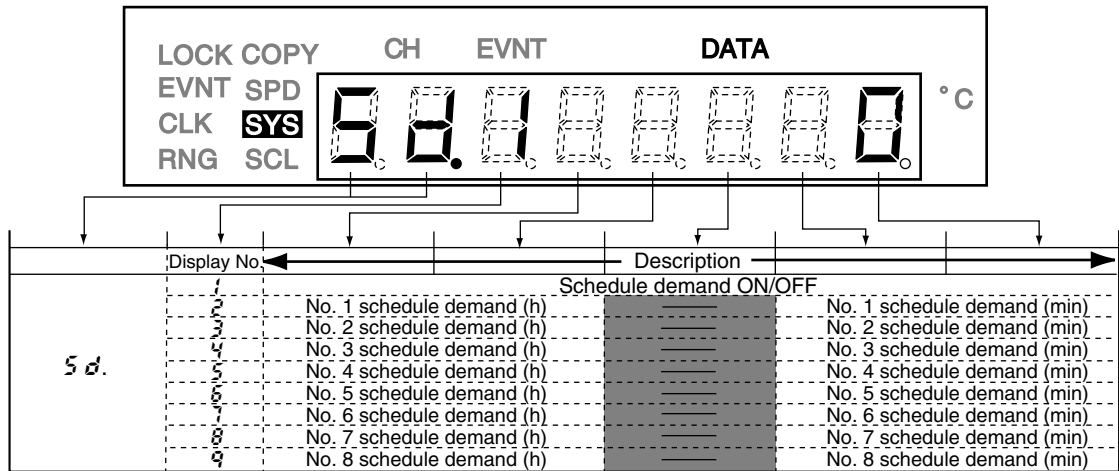

◇ Setup Details ◇

Schedule demand ON/OFF : "0" time setup disabled/schedule demand not printed

- "1" tabulation printing at time No.1
- "2" tabulation printing at times No.1 and No.2
- "3" tabulation printing at times No.1 to No.3
- "4" tabulation printing at times No.1 to No.4
- "5" tabulation printing at times No.1 to No.5
- "6" tabulation printing at times No.1 to No.6
- "7" tabulation printing at times No.1 to No.7
- "8" tabulation printing at times No.1 to No.8

◇ Setup example ◇

When tabulation printing is carried out at 9:00 and 17:00, set as follows:

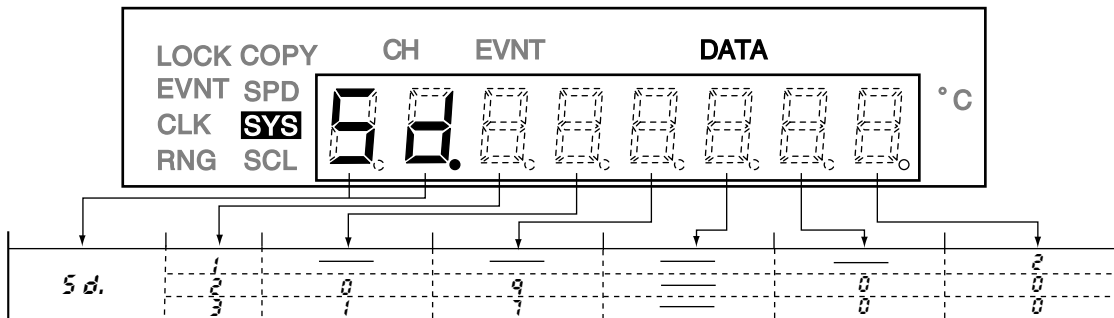

## ■ Description of Schedule Demand Setup

### ● Schedule demand

When “trend + schedule demand” is selected as the recording format, tabulation printing can be carried out at the desired time (h:min), for up to eight times per day.

Schedule demand can be used for recording at processes that require output of reports at predetermined times and for recording of process values at change of operator shifts. There will no recording omissions, as tabulation printing is carried out at the preset time, as long as recording of the schedule has been preset. Schedule demand cannot be used in combination with the “trend + tabulation” recording format.

### ❗ Handling Precautions

- If the time you have set is shorter than a fixed time, subsequent time setups are sometimes ignored, and recording is not carried out. This is because printing of the next schedule demand is not executed during printing of the previous schedule demand. The next setup time is ignored when it is reached during tabulation printing.
- Set the time of the schedule demand so that it does not conflict with printing of other schedule demands. Append the setup schedule demand times with a time interval. Calculate the minimum time interval for schedule demands according to the following formula:

$$\text{Time interval (min)} = (P \times L)/(V/60) + 1$$

where,

P: vertical pitch of character printing at chart feed speed\*

\* For details of vertical pitch, see page 6-14.

L: number of printing lines = In case of 6-dot printing mode, 2 lines  
 In case of 12-dot printing mode, 3 lines  
 In case of 24-dot printing mode, 4 lines

V: chart feed speed (mm/h)

(An extra minute is added on to ensure margin.)

Example: The minimum time interval at a chart feed speed of 30mm/h on a 12-dot model is calculated as follows:

$$(3.5 \times 3)/(30/60) + 1 = 22\text{min}$$

# 6 - 12 Message Setup

## ■ Message Setup

The message print function prints preset messages according to external switch inputs, internal contact inputs and communications on chart together with their times.

Select 1 (migration to extended setup mode) at display No. “*n.5*” in the system setup screen.

Press the **SET** key until “*n.5*” in the following figure is displayed:

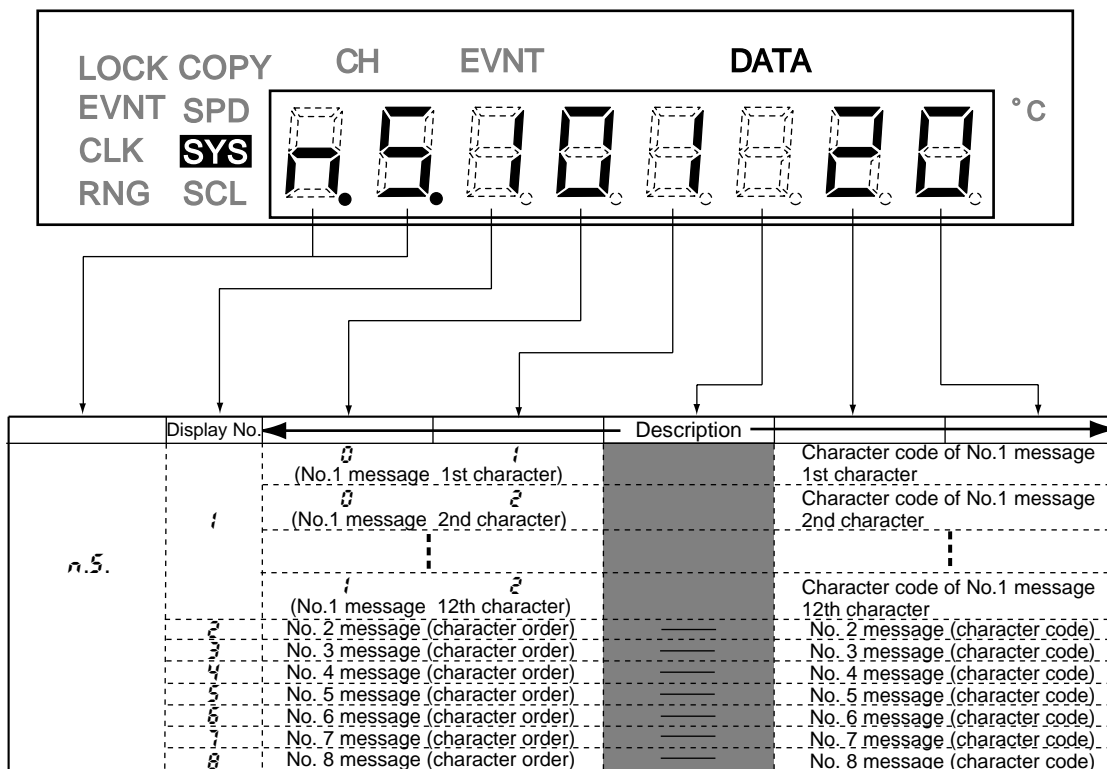

◇ Setup Details ◇

Character order : “1 to 12” 1st to 12th character

Message : Set by character code (See **6-20 Character Code Table**, page 6-49.)

Set the No.1 message as follows:

- (1) Make the number for the character order you want to set blink using the ◀ or ▶ keys, and enter the character order using the ▲ or ▼ keys.
- (2) Make the number for the character code blink using the ◀ or ▶ keys, and set the character you want to enter as a character code using the ▲ or ▼ keys.
- (3) Repeat steps (1) and (2). When you have finished setting all characters, press the **ENT** key. The screen migrates to the No.2 message setup screen.

**Note**

Set the No.2 message onwards in the same way as you set the No.1 message.

## 6 - 13 User Function Key Setup

### ■ Setting Configuration Lock

This recorder is provided with two function keys **UF1** and **UF2**. These keys can be assigned functions such as “output to internal contact” or “call up setup item.” Select “1” (migration to extended setup mode) at display No. “1” in the system setup screen.

Press the **SET** key until the following abbreviations (**U 1.** or **U 2.**) are displayed:

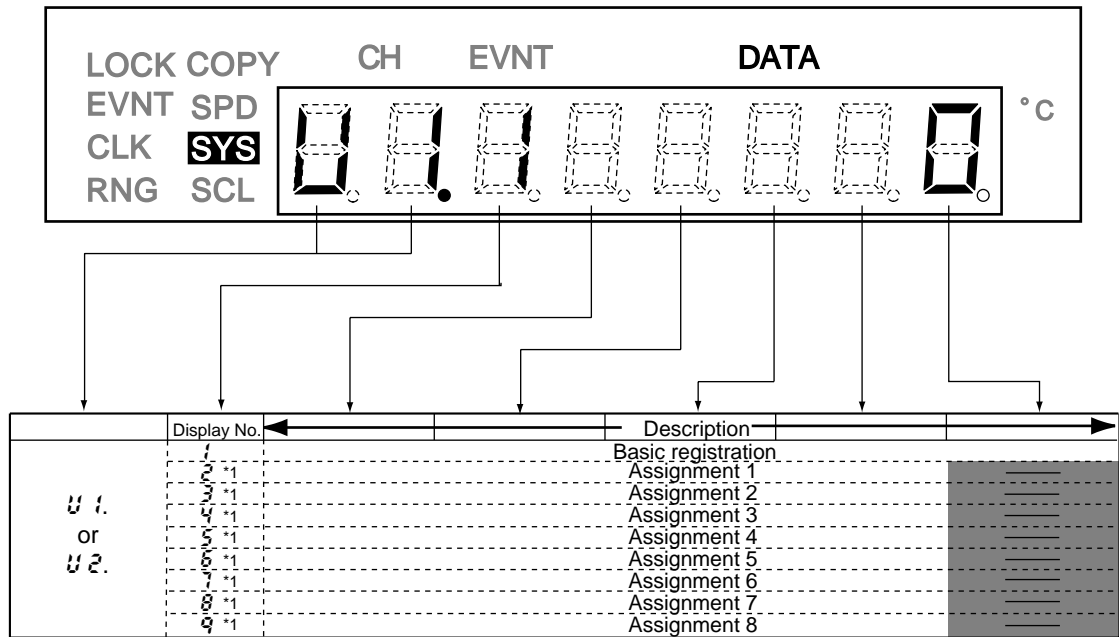

#### Note

\*1: This is displayed only when basic registration is set to “2”.

#### ◇ Setup Details ◇

Basic registration

: “0” OFF

“1” Output to internal contact input No.1\*

“2” Call up setup items

\* Pressing **UF1** outputs to internal contact No.1, and pressing **UF2** outputs to internal contact No.2.

Assignments 1 to 8

: A value “0” obtained by adding the radix shown in the table on the following page to the display No. in each setup you want to register means that no function has been assigned.

Item	Radix
Event setup	1nn00
Chart feed speed setup	1000
Date/Time setup	1500
System setup	2000
Range code setup (calculation setup is range setup + 5000)	2nn00
Scale setup	3nn00
Copy function	6500
Schedule demand setup	2500
Message setup	3000
Extended setup	3500
External switch input setup	4000
Internal contact input setup	4100
Relay output setup	4200
Open collector output setup	4300
Segment table 1 X-axis setup	5000
Segment table 1 Y-axis setup	5100
Segment table 2 X-axis setup	5200
Segment table 2 Y-axis setup	5300
Segment table 3 X-axis setup	5400
Segment table 3 Y-axis setup	5500

“nn” stands for the channel No. (01 to 24).

A value obtained by converting hexadecimal to decimal is used as the screen No.

## ■ Description of User Function Key Setup

### ● Example of how to calculate assignment settings

Assignment of the PV bias setup screen (display No. **b**) for the range setup of 13 channels is as follows.

First, assign nn=13 to 2nn00 as the range setup radix to set “21300”.

When the hexadecimal value of screen No. **b** is converted to decimal, the value becomes “11”.

So,  $21300 + 11 = 21311$

When “21311” is entered as the assignment setting, the 13-channel PV bias setup screen is switched to when the user function key is pressed.

### ⓘ Handling Precautions

If an internal contact is set to corresponding recording ON/OFF or functions such as level operations when a user configuration key is output for internal contact input, impractical cases may occur, for example, an operation is performed for the duration that the user configuration key is pressed.



## 6 - 14 Extended Setup

### Extended Setup

Extended setup allows you to set the following items:

- Recording start ON/OFF
- Count function selection
- Date type selection
- Atmospheric pressure (required for humidity calculation)
- Thermal resistance (required for F value calculation)
- Cold junction compensation

Select “1” (migration to extended setup mode) at display No. “ $\text{E.L.}$ ” in the system setup screen.

Press the **SET** key until the following abbreviation ( $\text{E.L.}$ ) is displayed:

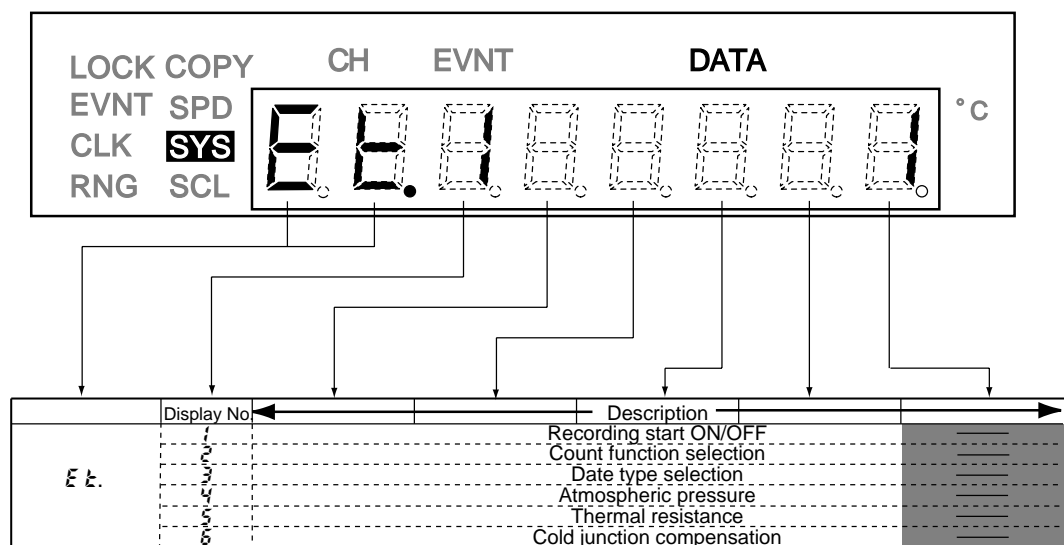

#### ◇ Setup Details ◇

- Recording start : “0” OFF  
“1” ON
- Count function selection : “1” Batch count  
“2” Binary count
- Date type selection : “0” JP (YY, MM, DD)  
“1” US (MM, DD, YY)  
“2” EU (DD, MM, YY)
- Atmospheric pressure : “670 to 1330” (hPa)
- Thermal resistance : “1.0 to 20.0”
- Cold junction compensation : “0” Compensation by recorder’s sensor OFF  
(externally compensated)  
“1” Compensation by recorder’s sensor ON

### Description of Extended Setup

#### ● Count function

This function sets whether to print numbers as binary codes or as incrementing numbers (batch count) each time that recording is started when printing at start of recording.

When binary code is set, numbers are determined by the state of the switch input according to the external switching input or internal contact input setting. When batch count is set, numbers are incremented one at a time each time that recording is started.

These 2-digit numbers are battery backed up and return to 00 after 99. The batch count can be cleared by external switch input or internal contact input.

● **Cold junction compensation**

The instrumentation system is configured as follows when you are compensating cold junction externally by thermocouple.

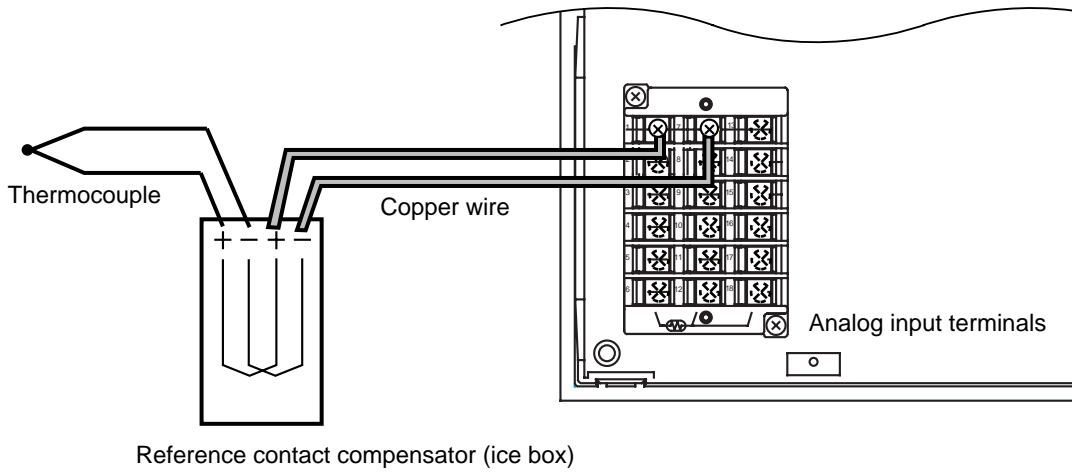

# 6 - 15 External Switch Input/Internal Contact Input Setup

## External Switch Input Setup

The following items can be set up only when the SRF206/212/224 supports external switch inputs (optional functions):

Select “2” (migration to DI/DO-related setup mode) at display No. “E” in the system setup screen.

Press the **SET** key until “E 5.” in the following figure is displayed:

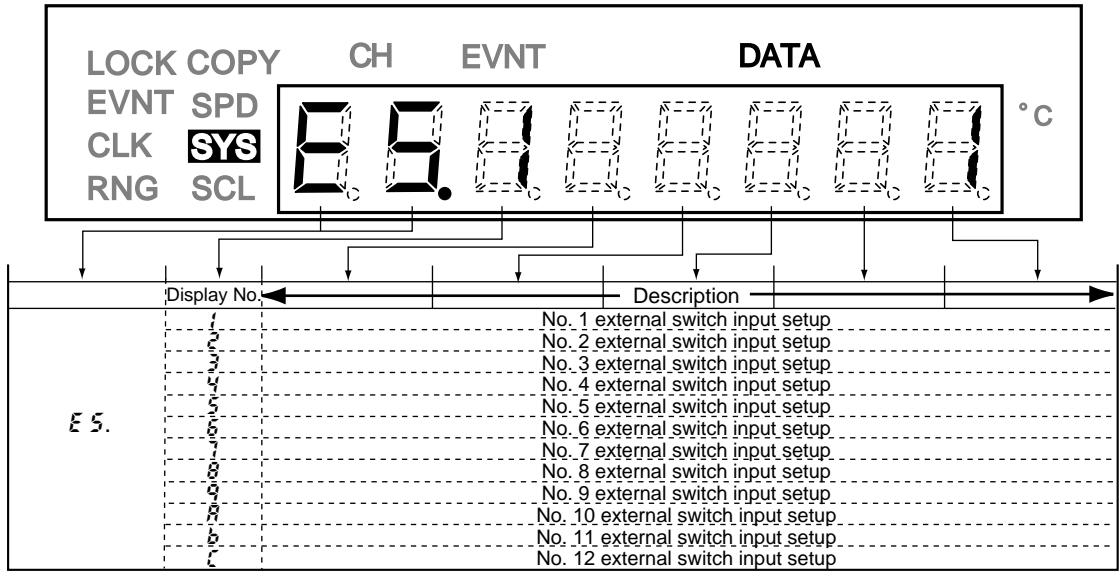

## Internal Contact Input Setup

Select “2” (migration to DI/DO-related setup mode) at display No. “E” in the system setup screen.

Press the **SET** key until the following abbreviation (“I 5.”) is displayed:

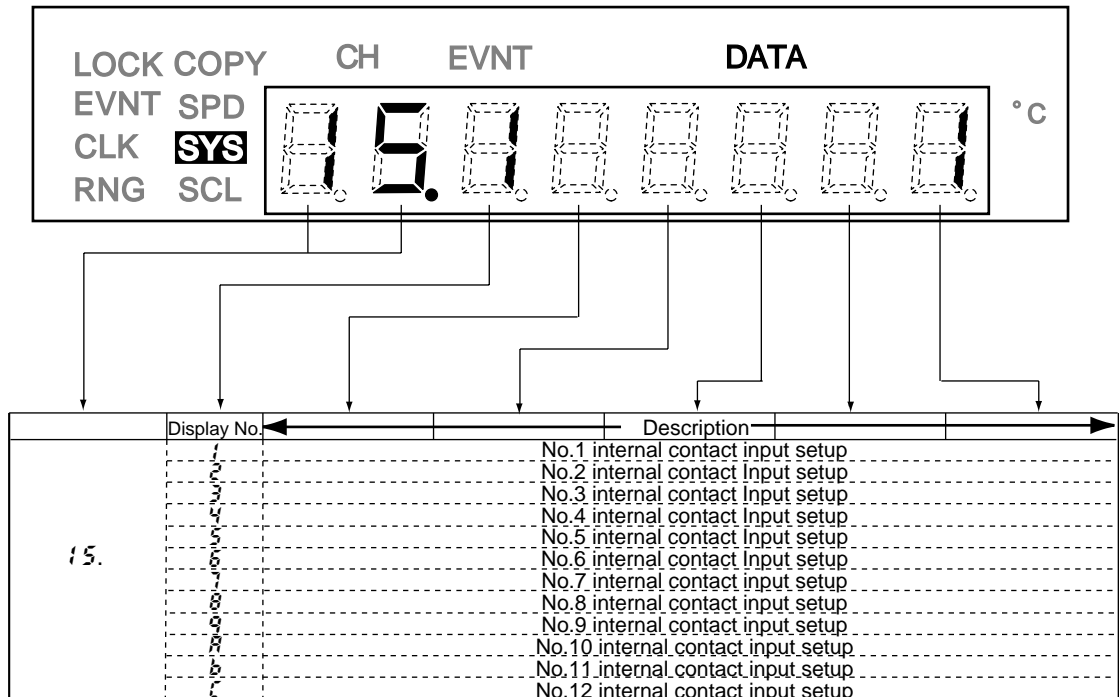

◇ Setup Details ◇

The setup details are the same for both external switch inputs and internal contact inputs.

External switch input setting, internal contact input setting

- : “0” function setup OFF
- “1” recording ON/OFF (unconditional)
- “2” demand printing
- “3” print all lists
- “4” print specified lists
- “5” chart feed
- “6” print communications lists
- “7” chart feed speed/scale selection
- “8” clear batch count
- “11” clear integrating calculation 1
- “12” clear integrating calculation 2
- “13” clear integrating calculation 3
- “14” clear integrating calculation 4
- “15” clear integrating calculation 5
- “16” clear integrating calculation 6
- “21” print No.1 message
- “22” print No.2 message
- “23” print No.3 message
- “24” print No.4 message
- “25” print No.5 message
- “26” print No.6 message
- “27” print No.7 message
- “28” print No.8 message
- “31” recording ON/OFF (channels 1 to 3)
- “32” recording ON/OFF (channels 4 to 6)
- “33” recording ON/OFF (channels 7 to 9)
- “34” recording ON/OFF (channels 10 to 12)
- “35” recording ON/OFF (channels 13 to 18)
- “36” recording ON/OFF (channels 19 to 24)
- “40” BIN code input  $2^0$  (+1)
- “41” BIN code input  $2^1$  (+2)
- “42” BIN code input  $2^2$  (+4)
- “43” BIN code input  $2^3$  (+8)
- “44” BIN code input  $2^4$  (+16)
- “45” BIN code input  $2^5$  (+32)

**!** Handling Precautions

To prevent malfunction caused by noise, changes in state are not detected unless they last for 500ms or more. (The figure below is for when “1” recording start ON/OFF.)

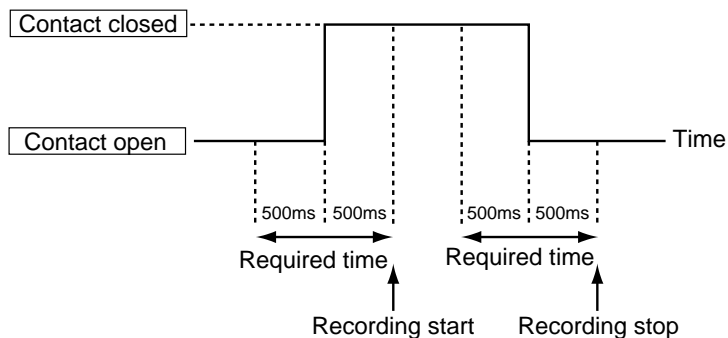

---

## ■ Description of External Switch Input/Internal Contact Input Setup

### ● Recording ON/OFF

- When “1” recording start ON/OFF is selected, recording is started and stopped by the state of external switch inputs or internal contact inputs.
- With “31 to 36” recording ON/OFF, only display and recording of channels whose recording mode is set to “3” (digital input-dependent), and occurrence of events is suppressed.

### ● Chart feed

With the “5” chart feed setting, the chart is fed at high speed for 40mm after which chart feed stops automatically when the external switch or internal contact state changes from open to closed.

### Handling Precautions

External switch inputs are not accepted during initialization (within 30s) of turning the power ON.

### Note

For details, see “**6-23 Operation of External Switch Input/Internal Contact Input Functions**” (page 6-56).

## 6 - 16 Relay Output Setup

### ■ Relay Output Setup

The following items can be set up only when the SRF206/212/224 supports relay outputs (optional functions):

Select 2 (migration to DI/DO-related setup mode) at display No. “2” in the system setup screen.

Press the **SET** key until “r o.” in the following figure is displayed:

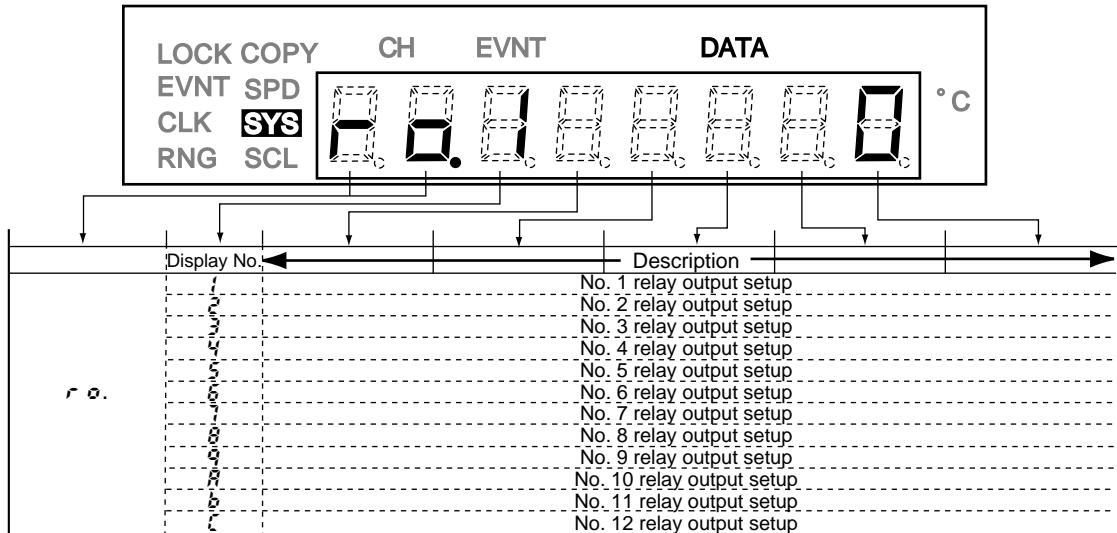

◇ Setup Details ◇

Relay output setting

- : “0” OR action/excitation/non-hold
- “1” OR action/excitation/hold
- “2” OR action/non-excitation/non-hold
- “3” OR action/non-excitation/hold
- “4” AND action/excitation/non-hold
- “5” AND action/excitation/hold
- “6” AND action/non-excitation/non-hold
- “7” AND action/non-excitation/hold
- “8” OR action/non-excitation/non-hold/event re-output
- “9” OR action/excitation/non-hold/event re-output

## ■ Description of Relay Output Setup

### ● Relay output operation

Generally, relay output operation is normally “0” (OR operation, excitation, non-hold). However, relay output can be set to operate in various ways by combining the following four functions described below:

Fully understand the descriptions for each of these functions before use. Relay output is sometimes not as expected if these functions are set incorrectly.

#### (1) Relay output AND/OR operation function

When a single relay output is shared on two or more events, you can select from the following two relay operations:

OR operation: Relay output when one of the two events occurs

AND operation: Relay output only when all events occur

The following shows event occurrence and relay output states:

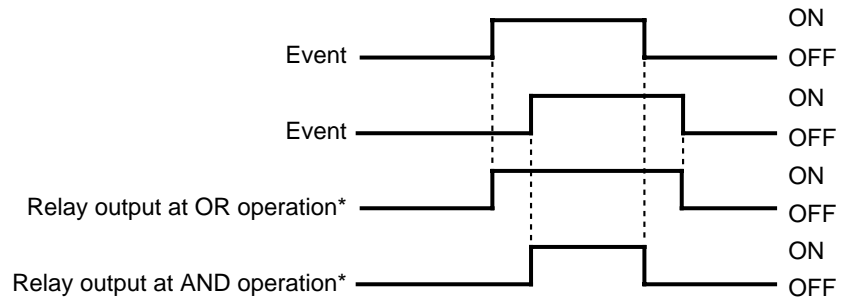

#### (2) Relay output excitation/non-excitation function

Excitation and non-excitation of relay outputs can be selected. The same output as when an event occurs when the power is turned OFF can be generated by selecting non-excitation.

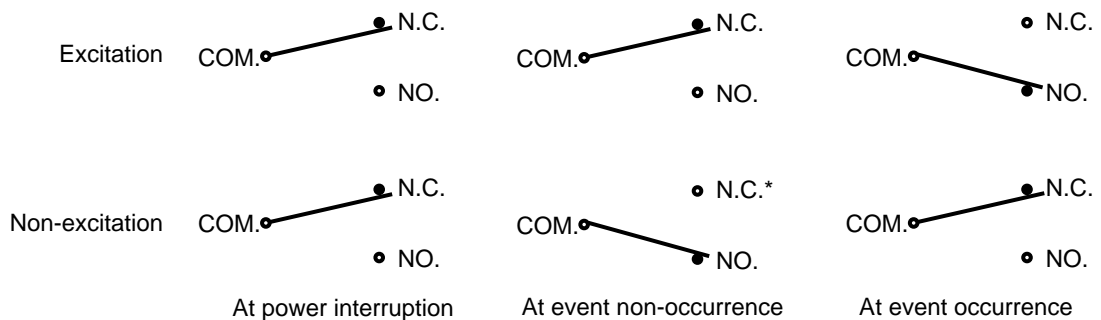

\* This operation is performed after initialization ends after the power is turned ON.

**(3) Relay output hold/non-hold function**

Hold and non-hold can be selected for relay outputs.

- Non-hold

Relay output is performed at turning ON/OFF of events.

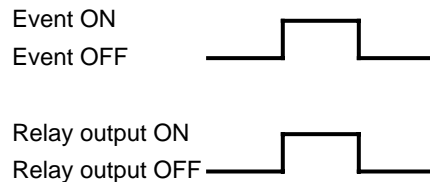

- Hold

Once an event occurs, relay output is held until the **ACK** key is pressed even if the event turns OFF.

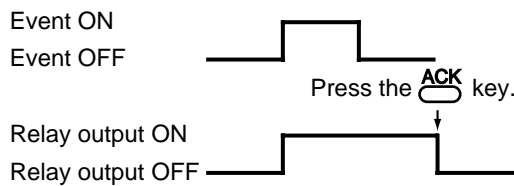

**(4) Event re-output function**

With a relay output to which two or more events are connected, relay output is set to an OFF state for about 500ms when relay output is set to an ON state by one of the events, after which the other event turns ON.

By this function, you can tell by the relay output that a new event has occurred during operation.

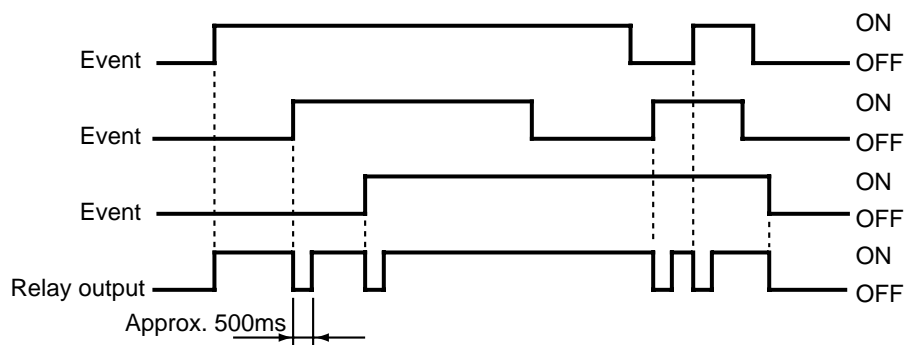

**! Handling Precautions**

When event re-output is set for relay output, the relay is pulse-operated for about 500ms. Use this function carefully as this causes the relay to chatter at actual output and may shorten the relay's life.

This need not be taken into consideration with open collector output.



# 6 - 17 Open Collector Output Setup

## ■ Open Collector Output Setup

The following items can be set only when the recorder is provided with open collector output (optional function):

Select “2” (migration to DI/DO-related setup mode) at display No. “2” in the system setup screen. Press the **SET** key until the following abbreviation (d.o.) is displayed:

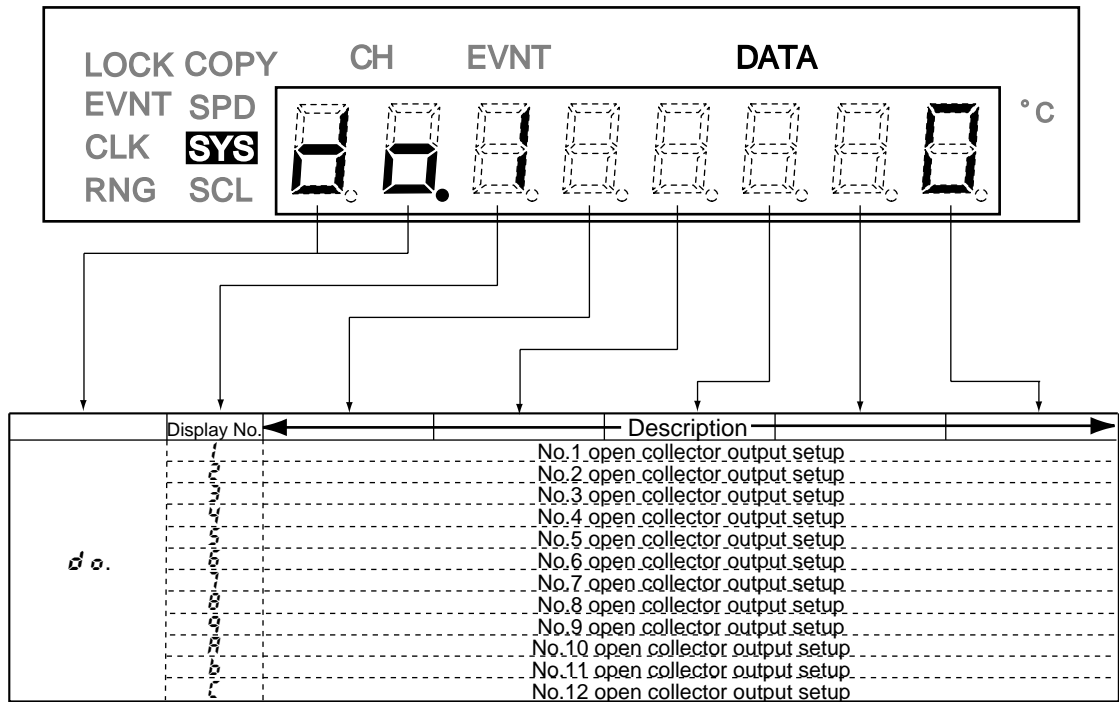

◇ Setup Details ◇

- Open collector output setup : “0” OR action/excitation/non-hold
- “1” OR action/excitation/hold
- “2” OR action/non-excitation/non-hold
- “3” OR action/non-excitation/hold
- “4” AND action/excitation/non-hold
- “5” AND action/excitation/hold
- “6” AND action/non-excitation/non-hold
- “7” AND action/non-excitation/hold
- “8” OR action/non-excitation/non-hold/event re-output
- “9” OR action/excitation/non-hold/event re-output

**Note**

For a description of the above functions, see pages 6-41 and 6-42.

# 6 - 18 Segment Table Setup

## ■ Segment Table Setup

The segment table must be set up by following the procedure below when “segment table use” is set in the calculation setup:

Select “3” (migration to segment table setup mode) at display No. “**3**” in the system setup screen. Press the **SET** key until the following abbreviations (**3A**, **3B**, **3C**, **3D**, **3E**, **3F**) is displayed:

### ● Segment table 1 setup

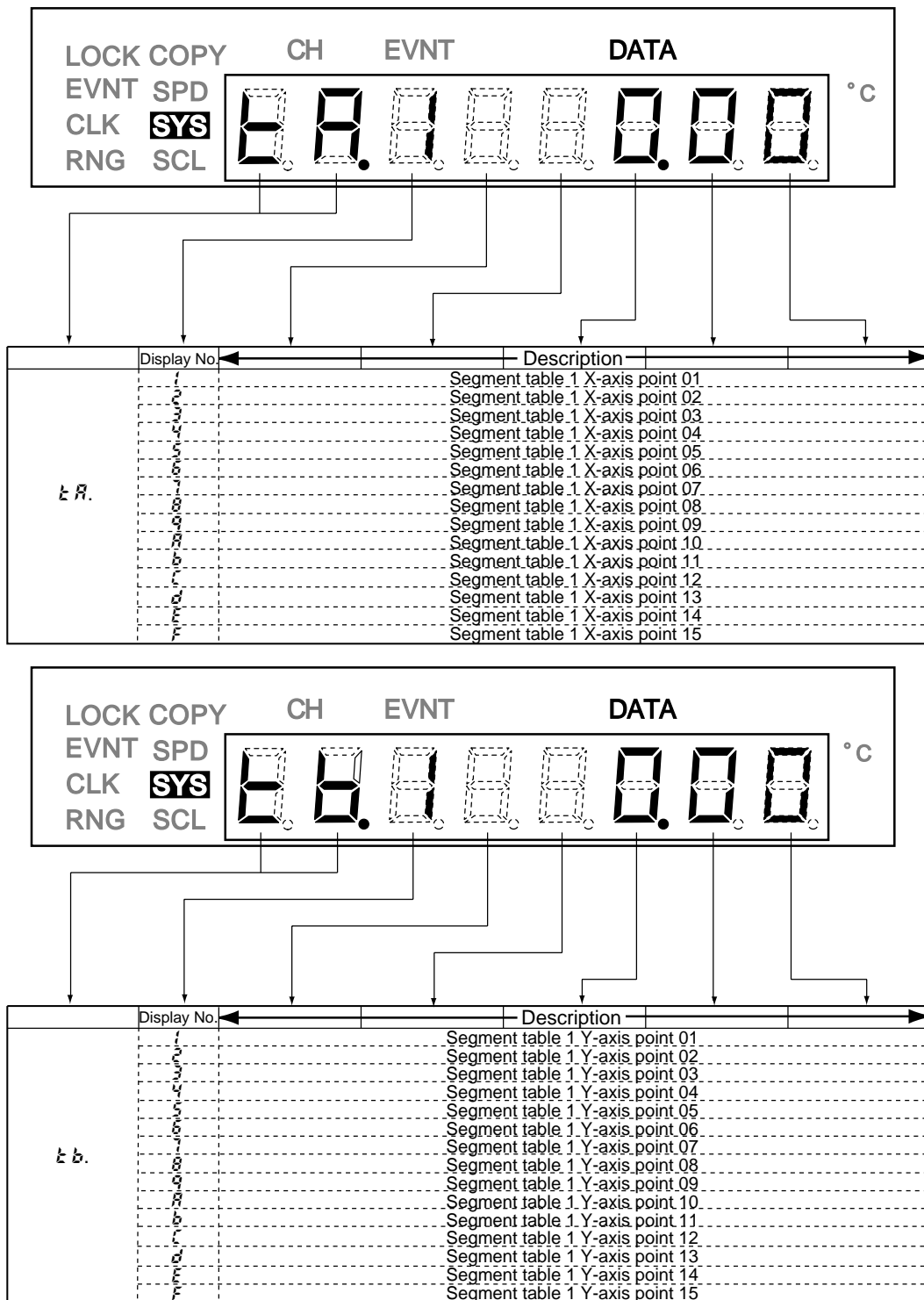

● Segment table 2 setup

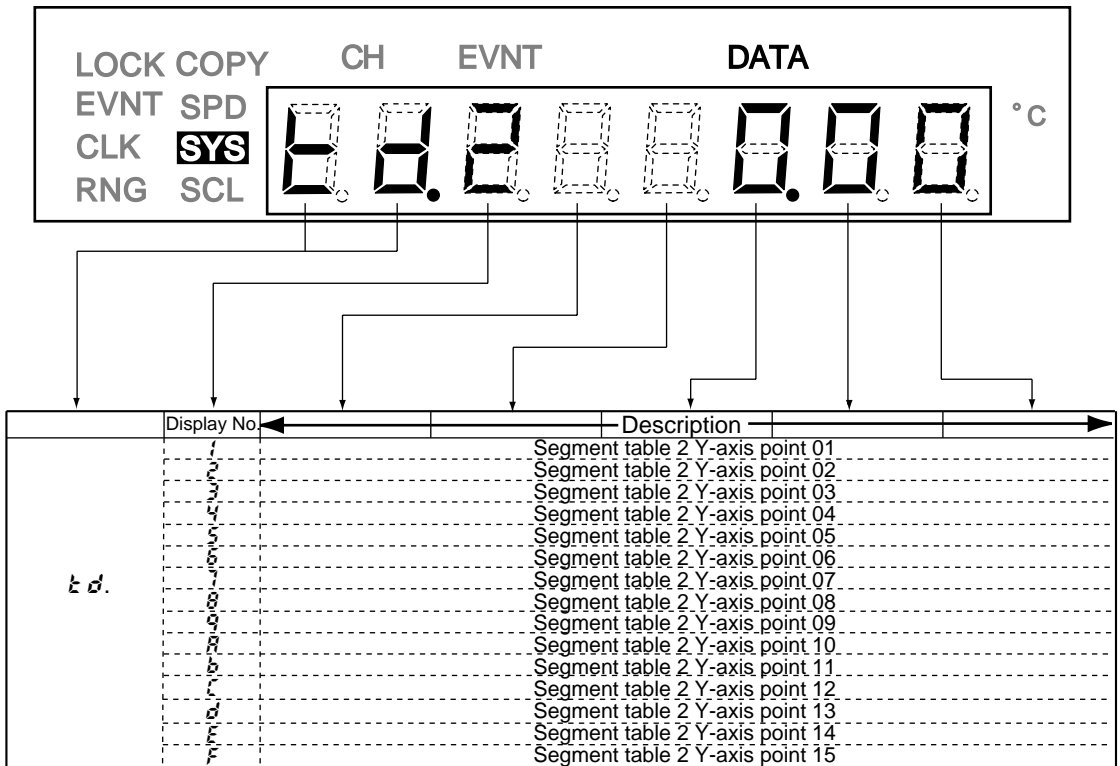
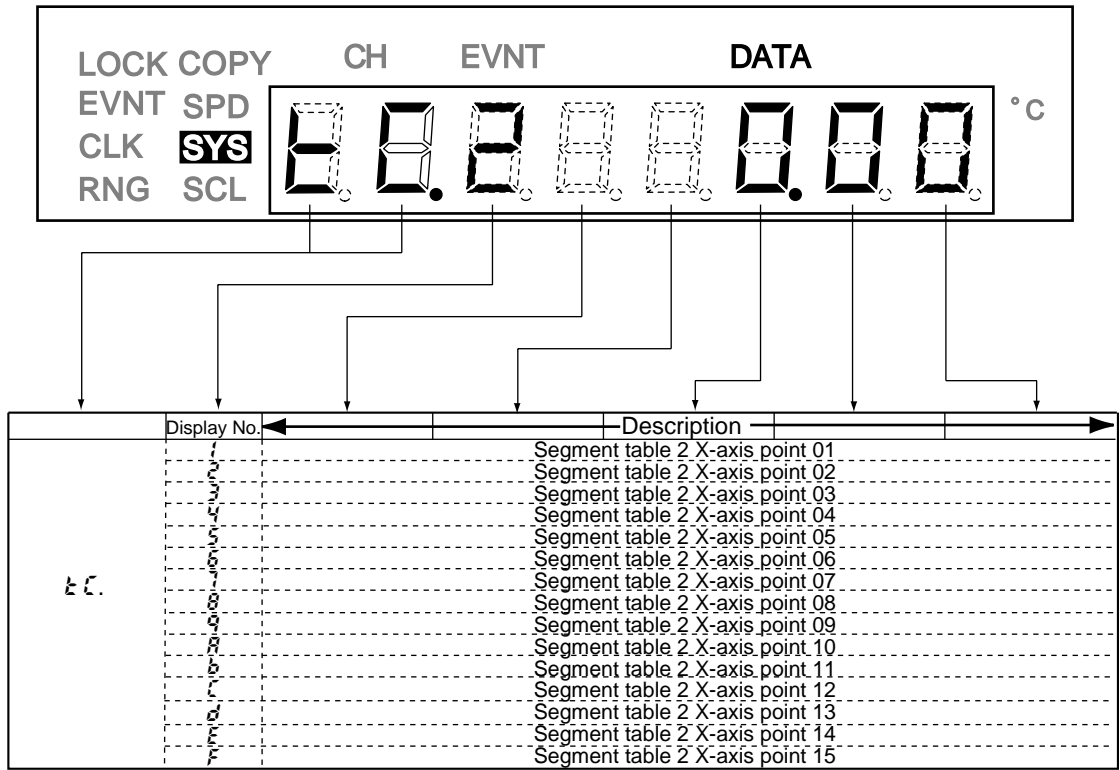

● Segment Table 3 Setup

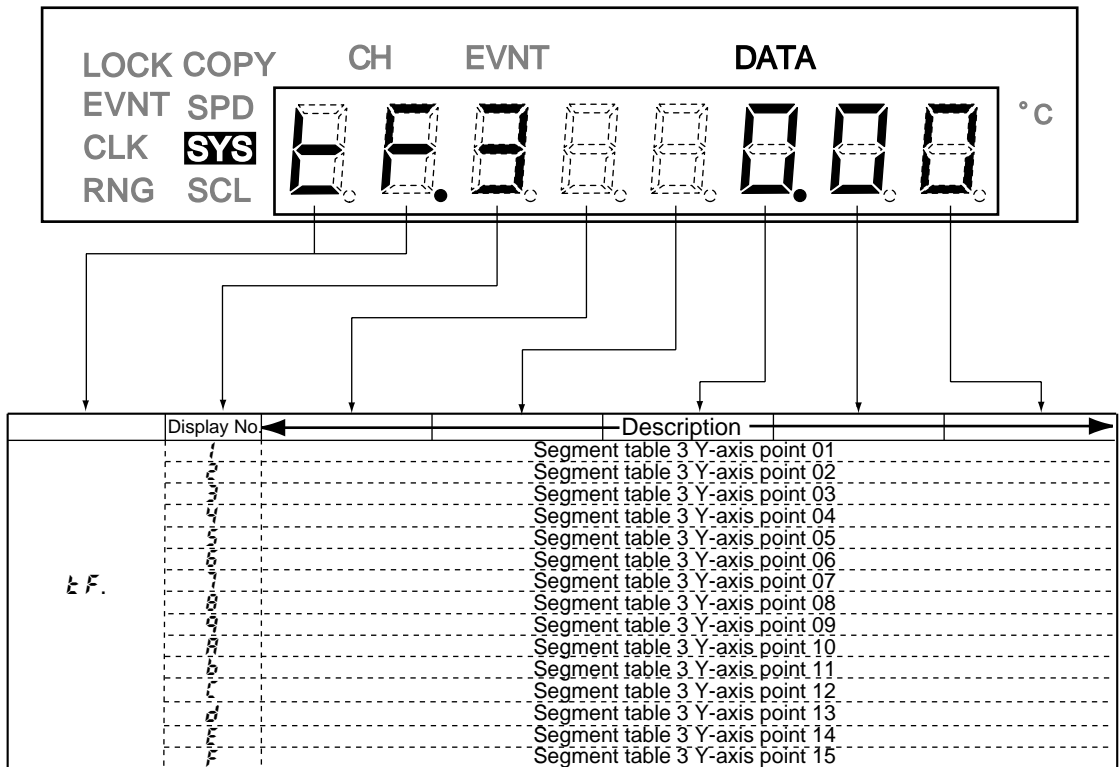
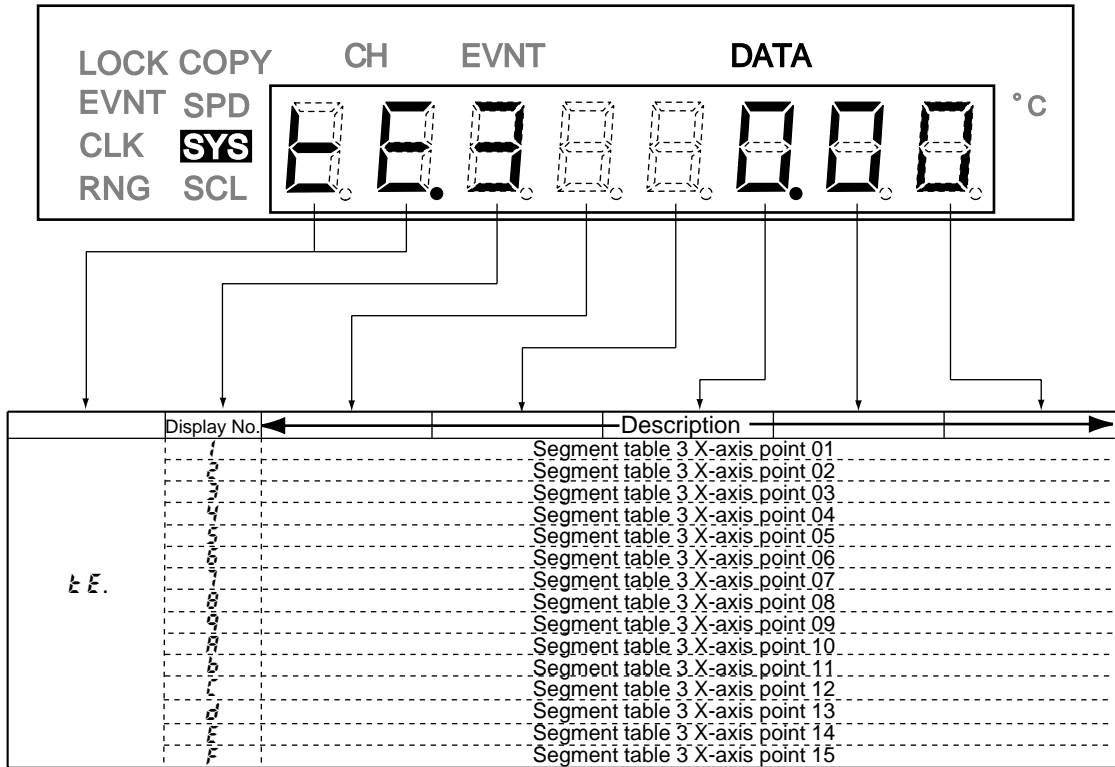

**Note**

For details on broken-line approximation, see “6-22 Calculation Functions” (page 6-51).

## 6 - 19 Range Code Table

Input Type		Range Code	Measurement Range (performance measurement range)
DC voltage Linear scaling range	mV	0	-20.00 to +20.00mV
		1	-40.00 to +40.00mV
		2	-60.00 to +60.00mV
	V	3	-200.0 to +200.0mV
		4	-2.000 to +2.000V
		5	-5.000 to +5.000V
DC voltage Input voltage direct-reading range <sup>*1</sup>	mV	6	0.000 to 10.000V
		10	-20.00 to +20.00mV
		11	-40.00 to +40.00mV
	V	12	-60.00 to +60.00mV
		13	-200.0 to +200.0mV
		14	-2.000 to +2.000V
Thermocouple	R	15	-5.000 to +5.000V
		16	0.000 to 10.000V
		20	0.0 to 1760.0°C
		21	0.0 to 1760.0°C
		22	0.0 to 1820.0°C
		23	-200.0 to +1370.0°C
		24	-220.0 to +800.0°C
		25	-200.0 to +1100.0°C
		26	-200.0 to +400.0°C
		27	0.0 to 1300.0°C
		28	0.0 to 2320.0°C
		29	0.0 to 2320.0°C
	30	0.0 to 1880.0°C	
31	0.0 to 1290.0°C		
32	0.0 to 1200.0°C		
Resistance temperature detector (RTD)	Pt100	40	-200.0 to +650.0°C
	JPt100	41	-200.0 to +550.0°C
	JPt50	42	-200.0 to +550.0°C
	Ni508	43	-50.0 to +150.0°C

Input Type		Range Code	Measurement Range (performance measurement range)
Thermocouple	R	50	32 to 3200°F
	S	51	32 to 3200°F
	B	52	32 to 3308°F
	K	53	-328 to +2498°F
	E	54	-328 to +1472°F
	J	55	-328 to +2012°F
	T	56	-328 to +752°F
	N	57	32 to 2372°F
	WRe0-26	58	32 to 4208°F
	WRe5-26	59	32 to 4208°F
	PR40-20	60	32 to 3416°F
	PLII	61	32 to 2354°F
Ni-Ni•Mo	62	32 to 2192°F	
Resistance temperature detector (RTD)	Pt100	70	-328.0 to +1202.0°F
	JPt100	71	-328.0 to +1022.0°F
	JPt50	72	-328.0 to +1022.0°F
	Ni508	73	-58.0 to +302.0°F
Communications <sup>*2</sup>	-----	80 to 87	-19999 to +29999
ON/OFF <sup>*3</sup>	-----	90	-----

- Notes
- \*1 Voltage values can be read directly without linear scaling.
  - \*2 Values acquired by communications are taken as PV input, and are recorded in the same way as normal input. A total of eight communications inputs (range codes 80 to 87) are supported. Communications inputs are processed as PV inputs by writing data to predetermined addresses (see communications address table) by communications.
  - \*3 ON/OFF-type digital signals are recorded as inputs. Specify the data acquisition No. by the next digital signal No. Specify the digital signal No. after selecting range code 90.

Digital Signal No.	Digital Data Acquisition Destination	Supplementary Explanation
01 to 14	Relay outputs No.1 to No.12	These can be specified regardless of actual digital input or output. However, if an unmounted digital input is specified, the setting is fixed at OFF.
13 to 24	Open collector outputs No.1 to No.12	
31 to 42	External switch inputs No.1 to No.12	
51 to 62	Internal contact inputs No.1 to No.12	

## 6 - 20 Character Code Table

Upper Bits Lower Bits	2	3	4	5	6	7	8
0		0	@	P	`	p	<sup>3</sup>
1	!	1	A	Q	a	q	°
2	“	2	B	R	b	r	◦
3	#	3	C	S	c	s	•
4	\$	4	D	T	d	t	
5	%	5	E	U	e	u	
6	&	6	F	V	f	v	
7	´	7	G	W	g	w	
8	(	8	H	X	h	x	
9	)	9	I	Y	i	y	
A	*	:	J	Z	j	z	
B	+	;	K	[	k	Ω	
C	,	<	L	¥	l		
D	—	=	M	]	m	μ	
E	.	>	N	^	n	<sup>2</sup>	
F	/	?	O	_	o	<sub>2</sub>	

The character setup range when the date type selection is “1” (US) or “2” (EU) is 20 to 8F (hex).

Setup Example:kPa

Step	Engineering Unit	Character Code
1	k	6B
2	P	50
3	a	61
4	(blank)	20
5	(blank)	20
6	(blank)	20

Setup Example:TIRC-1

Step	Tag	Character Code
1	T	54
2	I	49
3	R	52
4	C	43
5	-	2D
6	1	31
7	(blank)	20
•	•	•
•	•	•
•	•	•
12	•	•

## 6 - 21 About Digital Printing Priority

Digital printing on the SRF206/212/224 is subject to several restrictions to ensure that trend recording is not interrupted. This is called “printing control.” The following briefly describes printing control.

### ■ Printing Control During a Print Conflict

Digital printing is categorized into the following four groups: In principle, printing is carried out in the order in which it occurs within each group. However, start of printing is sometimes suppressed or printing is canceled midway according to the type of printing. If printing of one group conflicts with printing of another, either printing of one of the groups is suppressed or one of the groups is printed over the other. The following describes these restrictions:

Print Group	Print Item	Restrictions
A	Event	
B	Initial printing	
	Demand printing	Demand printing cannot be restarted during demand printing.
	Message	
	Schedule demand	Printing is canceled when demand printing occurs (even during print standby).
	Tabulation	
	Scale	Printing of this item is not started up when other printing is currently in progress or standing by.
	Channel No.	Printing of this item is not started up when other printing is currently in progress or standing by.
C	Chart feed speed selection	The current group is printed overlapping other groups.
D	Scale selection	Printing is canceled when a conflict with group A occurs. However, note that the change marker is recorded.

### ! Handling Precautions

- When printing of group A conflicts with printing of the scale upper limit or the scale tag/unit, printing of the scale upper limit or the scale tag/unit is canceled.
- When printing of group D conflicts with printing of the scale upper limit or the scale tag/unit, printing of group D is canceled. (Note that the change mark is recorded.)

### ■ Simultaneous Printing Control

When demand printing and message printing or schedule demand printing and message printing continuously stand by to be printed, a message is printed on the h:min line of demand printing (manual demand and schedule demand). Accordingly, the message print line no longer exists independently.



## 6 - 22 Calculation Functions

In addition to simply displaying and recording signals from analog inputs, you can also perform fixed processes using various arithmetic operations, and display and record the results. By simply setting the range code, you can display and record thermocouple ranges, for example, without being aware of the calculations that are performed. PV bias, for example, allows you to compensate sensor deviation, while PV filter allows you to prevent recording of minute deflection in processes. The figure below shows the flow of calculations until display/recording PV are obtained on this recorder.

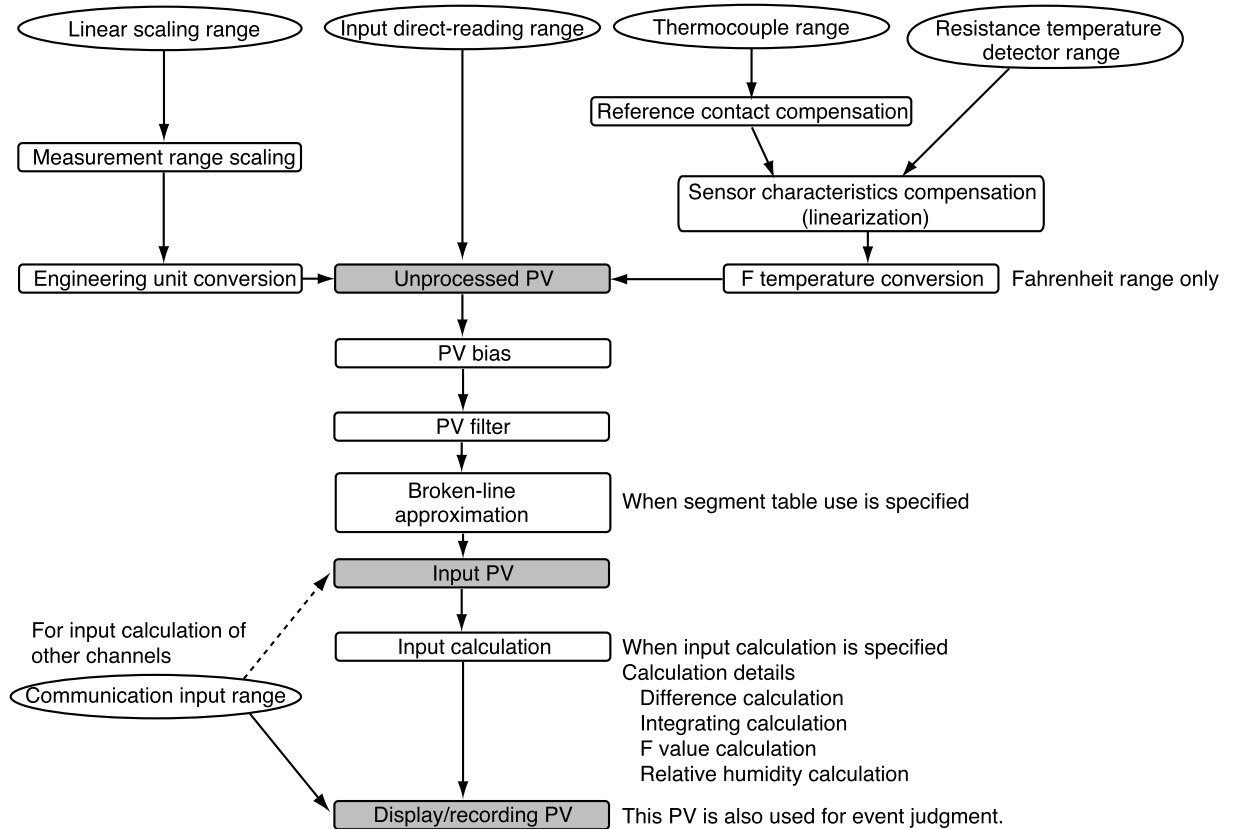

The following pages describe broken-line approximation and input calculations:

■ Broken-line approximation

Broken-line approximation can be applied to analog inputs. On which channel input broken-line approximation is to be applied is set in the calculation setup for each channel, and setting of the segment itself is performed by the segment table setup. The X-axis is the input axis, and the Y-axis is the output axis. The output of Y-axis segment point 01 is output for the input of X-axis segment point 01, and the section between each segment point is interpolated by a straight line. Both ends of the line are limited by the segment points of a valid setting. Inputs and outputs in the broken-line approximation calculation are set as percentages.

On channels for which segment table use is specified, X→Y conversion is performed on the resulting data after bias filter processing according to a specified segment table. Three segment tables 1, 2 and 3 are available. The maximum number of segment points in each segment table is 15, and X→Y conversion is possible on the settings of 14 segments.

Linear interpolation is calculated by a normalization value (range %). So, also set the X- and Y-axis setting values of each segment point as a range percentage value (-10.00 to +110.00%).

The same segment table can be used on multiple channels.

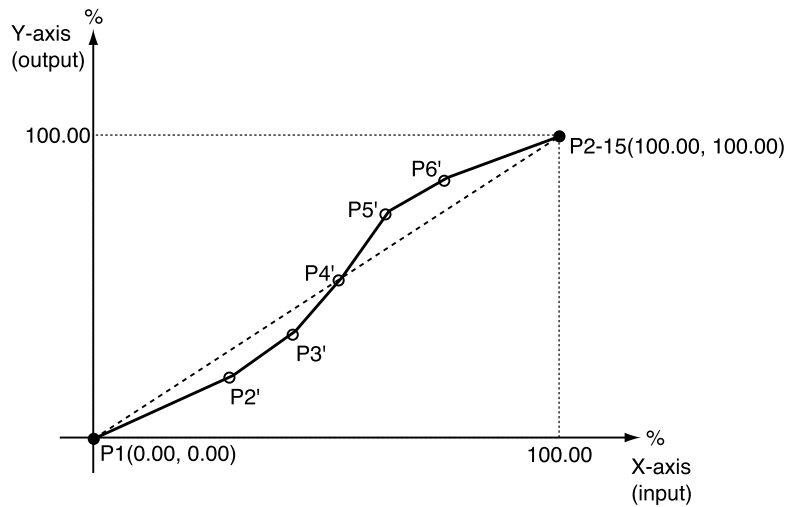

● Concept of broken-line approximation

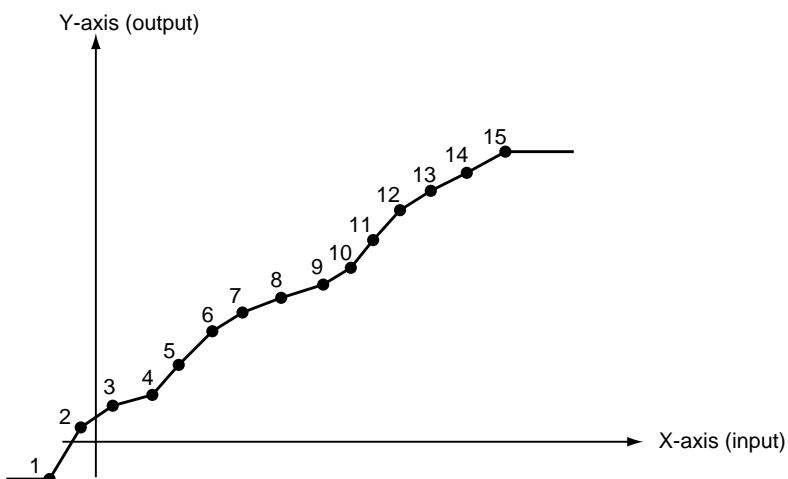

The relationship between segment points on only the X-axis must be set so that the broken line increases such as X1=0.00, X2=10.00 and so forth. If this relationship is not set as such, the aberrant point (X2, Y2 in the figure below) is excluded to make a broken line with ever-increasing X-axis values.

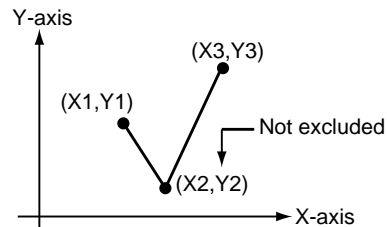
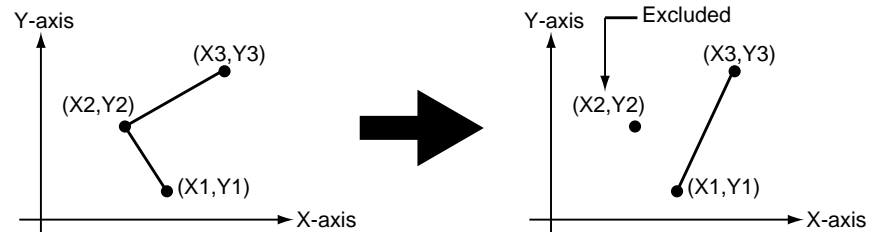

- When two values on the X-axis are equal such as X1=X2, take Y1 to be the output value.

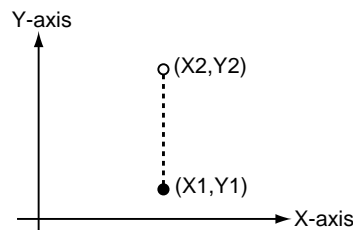

## ■ Input Calculation

### ● Difference calculation (input calculation type: 1, 2, 3)

Difference calculation is a function that uses the reference channel, current channel, PV filter value, PV bias values and the fixed value for deviation to calculate the difference, and display and record the calculation result as the data of the current channel.

- Calculation example 1

	Channel 1	Channel 2
Input PV	5.000	4.000
Calculation No.: calculation details	1:ch1-ch2	3:ch2-fixed value
Calculation parameter 1	1	1.000
Calculation parameter 2	2	—
Recording/Display PV	1.000	3.000

Calculation equation

$$\text{ch1} = 5.000 - 4.000 = 1.000$$

$$\text{ch2} = 4.000 - 1.000 = 3.000$$

• Calculation example 2

	Channel 1	Channel 3
Input PV	5.000	40.00
Calculation No.: calculation details	1:ch3-ch1	2:fixed value-ch3
Calculation parameter 1	3	100.00
Calculation parameter 2	1	—
Recording/Display PV	35.000	60.000

Calculation equation

$$ch1=40.00-5.000=35.000$$

$$ch3=100.00-40.00=60.00$$

● **Integrating calculation (input calculation type: 4)**

This function integrates flowrate, for an example. To activate integrating calculation, the integration reset function must be assigned to external switch inputs/internal contact inputs.

When the state of the external switch inputs/internal contact inputs is OFF when PV input is updated, integration is reset, and integration is continued when the state is ON.

When integration is reset, the displayed and recorded PV changes to 0.

Six integration resets, 1 to 6, are available for external switch inputs/internal contact inputs. Specify whether or not to use integration reset in calculation parameter 2.

$$Y(t)=Y(t-1)+\frac{1}{10^a} \cdot X(t)dt \quad \text{where} \quad X(t)dt=\frac{T_s}{T_b} \cdot X$$

where,

Y (t) : integration amount

Y (t-1): integration amount at the previous sampling

X : instantaneous integration data (input PV of current channel)

Ts : sampling time : 15s on 6-dot and 12-dot printing models, and 30s on 24-dot printing models.

Tb: integration time unit : Select from the following integration times in calculation parameter 1.

0: s (Tb=1s)

1: min (Tb=60s)

2: h (Tb=3600s)

a: integration weighting : Specified within the range 0 to 10 in calculation parameter 3

- The integration reset function that is assigned to external switch inputs/internal contact inputs operates simultaneously on all assigned integration calculations.
- When two or more integration reset functions have been assigned to a single external switch input/internal contact input, the ON state of the input is OR-ed. So, integration continues if one of the integration reset inputs is ON.
- The number of digits past the decimal point in the calculation result is two digits regardless of the input range.
- The calculation result is limited to the range -199.99 to +299.99.
- Digits whose integration amount in a single integration calculation is  $10^{-13}$  or less are not integrated and are discarded.

(When the integrating time unit is “hours” and the weighting is  $10^{-10}$ , integration is not performed when X(t) is approximately 2.5 or less.  $10^{-10} \times 15/3600 \times 2.5 \approx 1.0 \times 10^{-12}$ . So, all digits of  $10^{-13}$  or less are treated as an error.)

### ● F value calculation (Input calculation type: 5)

This function calculates the time (min units) that food, for example, is sterilized. To activate F value calculation, the integration reset function must be assigned to external switch inputs/internal contact inputs.

When the state of the external switch inputs/internal contact inputs is OFF when PV input is updated, the F value is reset, and F value calculation is continued when the state is ON.

Six integration resets, 1 to 6, are available for external switch inputs/internal contact inputs. Specify whether or not to use integration reset in calculation parameter 2.

$$Y(t)=Y(t-1)+10^{\frac{T-a}{b}} \cdot dt \quad \text{where} \quad 10^{\frac{T-a}{b}} \cdot dt = \frac{T_s}{60} \cdot 10^{\frac{T-a}{b}}$$

where,

Y (t) : F value

Y (t-1) : F value at the previous sampling

T: product temperature (input PV of current channel)

Ts: sampling time : 15s on 6-dot and 12-dot printing models, and 30s on 24-dot printing models.

a : standard reference temperature : Specify this temperature in calculation parameter 1. (default: 121.1°C)

b : thermal resistance : Set in special parameters common to all channels.

- The integration reset function that is assigned to external switch inputs/internal contact inputs operates simultaneously on all assigned F value calculations.
- When two or more integration reset functions have been assigned to a single external switch input/internal contact input, the ON state of the input is OR-ed. So, the F value calculation continues if one of the integration reset inputs is ON.
- The number of digits past the decimal point in the F value calculation result is two digits regardless of the input range.
- The calculation result is limited to the range -199.99 to +299.99.
- The F value calculation result is expressed in min.

Note, however, that the unit setting takes precedence when the linear scaling range is set.

### ● Relative humidity calculation (Input calculation type: 6)

This function calculates the relative humidity from the dry bulb temperature and the wet bulb temperature.

- The relative humidity cannot be calculated if the following condition is not satisfied: 0.0°C < wet bulb temperature, dry bulb temperature ≤ 100.0°C  
PV is displayed as “— — — — —” and printed as “\*\*\*\*”.
- The number of digits past the decimal point in the relative humidity calculation result is one digit regardless of the input range.

### Note

We recommend using a resistance temperature detector from the standpoint of input accuracy of the sensor.

## 6 - 23 Operation of External Switch Input/Internal Contact Input Functions

No.	Function Name	Trigger Condition	Operation Description
0	Function setup OFF		None
1	Recording ON/OFF		Starts recording.
			Stops recording.
2	Demand printing		Starts printing.
3	Print all lists		Starts printing.
4	Print specified lists		Starts printing.
5	Chart feed		Starts chart feed.
6	Print communications lists		Starts printing.
7	Chart feed speed/scale selection		Selects No.2 chart feed speed.
			Selects No.1 chart feed speed.
8	Clear batch count		Clears batch count.
11	Clear integrating calculation 1	Level operation ON (close): Recording OFF OFF (open): Recording ON	
12	Clear integrating calculation 2		
13	Clear integrating calculation 3		
14	Clear integrating calculation 4		
15	Clear integrating calculation 5		
16	Clear integrating calculation 6		
21	Print No.1 message		Starts printing.
22	Print No.2 message		
23	Print No.3 message		
24	Print No.4 message		
25	Print No.5 message		
26	Print No.6 message		
27	Print No.7 message		
28	Print No.8 message		
31	Recording ON/OFF (channel 1 to 3)	Level operation ON (close): Recording OFF OFF (open): Recording ON	
32	Recording ON/OFF (channel 4 to 6)		
33	Recording ON/OFF (channel 7 to 9)		
34	Recording ON/OFF (channel 10 to 12)		
35	Recording ON/OFF (channel 13 to 18)		
36	Recording ON/OFF (channel 19 to 24)		
40	Binary code input 2 <sup>0</sup> (+1)	Level operation ON (close): Code incremented. OFF (open): Incrementing OFF	
41	Binary code input 2 <sup>1</sup> (+2)		
42	Binary code input 2 <sup>2</sup> (+4)		
43	Binary code input 2 <sup>3</sup> (+8)		
44	Binary code input 2 <sup>4</sup> (+16)		
45	Binary code input 2 <sup>5</sup> (+32)		

# Chapter 7. MAINTENANCE

## 7 - 1 Periodic Inspection

To ensure prolonged use of the SRF206/212/224, periodically inspect the operating status of the SRF206/212/224 and maintain it in a proper working condition. Perform the following inspections, and replace consumables and maintenance parts as required:

Inspection Item	Remedy	See page
Faint recording or printing	If recording is faint replace the ink ribbon cassette. The life of the ink ribbon is about three months at a chart feed speed of 20mm/h. (This varies according to operating conditions.)	4-1
Incorrect feeding of chart, or paper jam	Re-load the chart.	4-1
Insufficient remaining chart	The remaining amount of chart is printed at 10mm intervals on the right side of the chart. When only 60cm of chart remains, the remaining chart warning is printed on the chart. Replace with new chart.	4-1
Alarm code "AL03" displayed	Replace with a new battery.	7-3
Alarm code other than "AL03" displayed	We recommend periodically cleaning the SRF206/212/224.	Chapter 8
Dust collection inside the SRF206/212/224	Wipe off any dust inside the SRF206/212/224 with a soft brush, and suck up the dust with a vacuum cleaner. Also, use soft cloth or paper that does not produce any fluff to prevent the shaft from becoming scratched. Wipe the shaft with soft cloth or paper moistened with ethyl alcohol only when it is difficult to remove dirt or stains from the shaft. <b>! Handling Precautions</b> <ul style="list-style-type: none"> <li>When cleaning the SRF206/212/224, take care not to damage the flexible board on the wire dot head.</li> <li>The SRF206/212/224 does not need to be lubricated with lubricating oil. Do not apply lubrication oil to any parts or components on the SRF206/212/224. Doing so might attract dust or increase wear.</li> <li>Be sure to use cloth or paper that does not produce any fluff when cleaning the shaft. Fluff adversely affects operation of the wire dot head. Recommended cleaning cloth: Kim Wipe® made by Crecia Co., Ltd</li> </ul>	–
Dust collection on the door window	Wipe dust from the door window using soft dry cloth or paper. <b>! Handling Precautions</b> Never wipe the door window with paint thinner or other organic solvents. Doing so might cause the window to crack or cloud.	–
Loose wiring	Tighten the wiring within the rated torque.	
Cracked or loose terminal cover	Attach the cover if loose. If the cover is missing, obtain a maintenance part.	–

### Handling Precautions

- If you leave the SRF206/212/224 for a long time with the ink ribbon cassette loaded in the SRF206/212/224, ink will become faint on only the parts that contact the air. For this reason, part of the recording may become faint at periodic intervals when the SRF206/212/224 is next used.
- If you leave the SRF206/212/224 for a long time with the chart loaded in the chart cassette, the chart may become discolored due to sunlight or it may become wrinkled. For this reason, the chart may not fold properly when the SRF206/212/224 is next used.
- We recommend carrying out the following when you are not using the SRF206/212/224 for a long time:
  1. Remove the ink ribbon cassette, insert the cassette into a vinyl bag and seal the bag.
  2. Remove the chart from the chart cassette, and return the chart to the chart box.



## 7 - 2 Replacing the Clock Backup Battery

### ⚠ WARNING

- ❗ To prevent danger before you replace the clock backup battery, turn the power OFF, and disconnect the SRF206/212/224 from its power supply.
- ⊘ Do not insert the battery with the polarities (+, -) reversed.
- ⊘ Do not use damaged (broken battery skin, leaking battery fluid) batteries.
- ⊘ Do not throw batteries into fires, or charge, short-circuit, disassemble or heat batteries.
- ❗ Store batteries out of the reach of small children. Batteries are small and are easy to swallow. If a child swallows a battery, consult a physician immediately.
- ❗ Return used batteries to Yamatake Corporation or your dealer. When disposing of used batteries at the user site, observe local bylaws.

The clock backup battery is for backing up the clock data in the event of a power interruption and memorizing the recording start/stop state.

The life of the clock backup battery is about five years. If you forget to replace the battery, or the battery is out of power, alarm code “**AL03**” is displayed on the display when the power is turned ON, clock data is initialized to “2000/01/01 00:00”, and the recording mode is set forcibly to the recording start mode.

Though the SRF206/212/224 can be operated in this state, we recommend replacing the clock backup battery as soon as possible.

Various setup data are stored to nonvolatile memory. So, these data need not be reset when the clock backup battery is replaced.

#### ● Items to be prepared

- Phillips screwdriver
- Lithium battery (CR2430)  
(Buy at an electrical appliance or camera store.)

#### ● Replacement procedure

(1) Draw out the chart cassette.

For details on how to draw out the chart cassette, see **4-1 Preparation (loading the chart and ink ribbon cassette)** (page 4-1).

(2) Remove the four screws fastening the chassis.

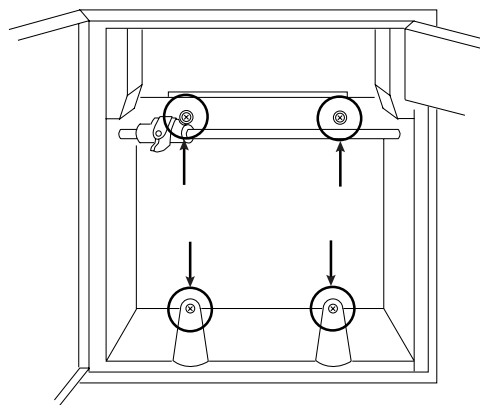

(3) Pull out the chassis to draw out.

(4) Lift up the battery from the battery holder on the board inside.

**! Handling Precautions**

- Touch only the battery holder. Do not touch other parts with your hands.
- Take care to prevent surrounding parts or the PCB pattern from becoming scratched.

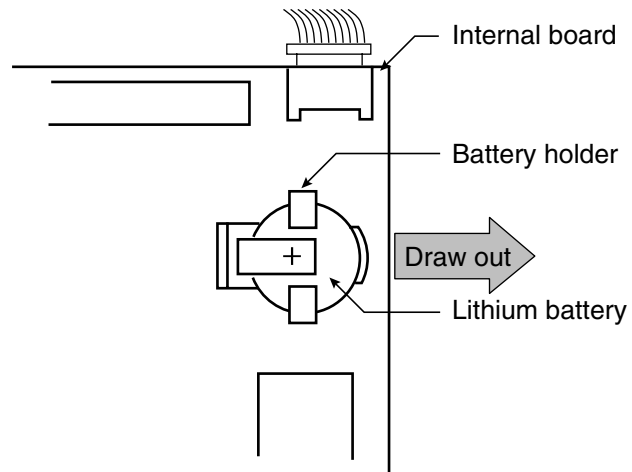

(5) Remove the battery from its holder.

(6) Insert a new battery into the battery holder with the plus (+) side facing up.

(7) Return the chassis to its original position, fasten and turn the power ON.

(8) Reset the date and time.

## 7 - 3 Replacing the Fuse

### WARNING



To prevent danger before you replace the fuse, turn the power OFF, and disconnect the SRF206/212/224 from its power supply.



To prevent fire, use only the specified fuse. Do not use other fuses.

Replacement part No. : 81446289-002 (10-fuse pack)

Fuse rating : 3A 250V, Time-lag (IEC127)

#### Handling Precautions

Replace fuses periodically (about every two years) to prevent unexpected blowing.

#### ● Items to be prepared

- Phillips screwdriver
- Flathead screwdriver
- Replacement parts Fuse (81446289-002)

#### ● Replacement procedure

(1) Draw out the chassis.

For details on how to draw out the chassis, see page 7-3.

(2) The fuse holder is located on the side of the case. Turn the screw counterclockwise to remove the fuse.

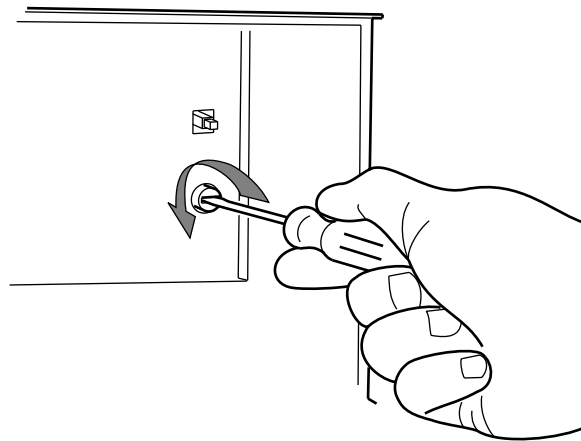

(3) Insert the new fuse in the fuse holder, and turn the screw in the clockwise direction to fasten the fuse holder.

(4) Return the chassis to its original position, fasten and turn the power ON.

## 7 - 4 Measuring the Display Accuracy of Analog Inputs

This section describes how to measure the display accuracy (including digital printing by tabulation) of analog inputs. We recommend measuring the display accuracy of analog inputs once every year to ensure appropriate use of the SRF206/212/224.

If, as a result of measurement, it is found that accuracy deviates from the specified display accuracy of the SRF206/212/224 (see **9-2 Input Types, Ranges and Display Accuracy** (page 9-7)), perform one-point adjustment using the PV bias (see **6-7 Range Setup** (page 6-19)). If the SRF206/212/224 needs to be calibrated, contact your dealer.

### ■ Equipment Required for Measurement

The standard display accuracy of the SRF206/212/224 is 0.15%. When measuring the standard display accuracy, use equipment having an accuracy higher than this.

- DC standard voltage generator: When measuring DC voltage and thermocouple inputs
- Standard contact compensator (ice box): When measuring thermocouple inputs
- Dial variable resistor: When measuring resistance temperature detectors (RTD)

### ■ Measurement Environment

The standard display accuracy of the SRF206/212/224 is based upon the standard conditions listed in **9-2 Input Types, Ranges and Display Accuracy** (page 9-7). These conditions must also be satisfied when measuring the accuracy of analog inputs. If accuracy is measured outside of these conditions, the following additional accuracies must be included the display accuracy measurement:

#### ● Additional accuracies

(ambient temperature characteristics)

- Indication and recording fluctuations in response to temperature changes of  $\pm 10^{\circ}\text{C}$ :  
(excluding standard contact temperature compensation error at thermocouple input)  
Indication fluctuation: Within  $\pm(0.1\% \text{F.S.} + \text{resolution} \times 2)$   
Recording fluctuation: Within (display fluctuation) + (0.3%F.S.)  
(excluding influence of chart expansion/shrinkage)

(ambient humidity characteristics)

- When humidity changes from 60% to 85%RH:  
Indication fluctuation: Less than  $\pm 0.1\% \text{F.S.}$
- When humidity changes from 60% to 45%RH:  
Indication fluctuation: Less than  $\pm 0.1\% \text{F.S.}$

### ■ Procedure

- Wire to each of the input types as shown in the figure on the next page, and warm up the recorder for at least 60min.
- Make sure that the ambient temperature, humidity and other environmental conditions are within their respective standard conditions.
- Apply inputs equivalent to 0% and 100% of the input range, read the indications at this time, and measure the error from the difference with the input values.

● When measuring DC voltage

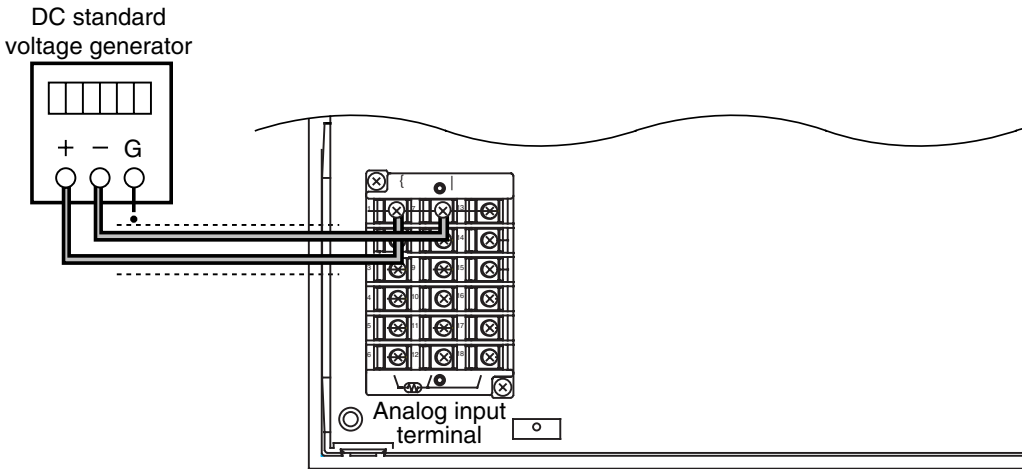

● When measuring a thermocouple

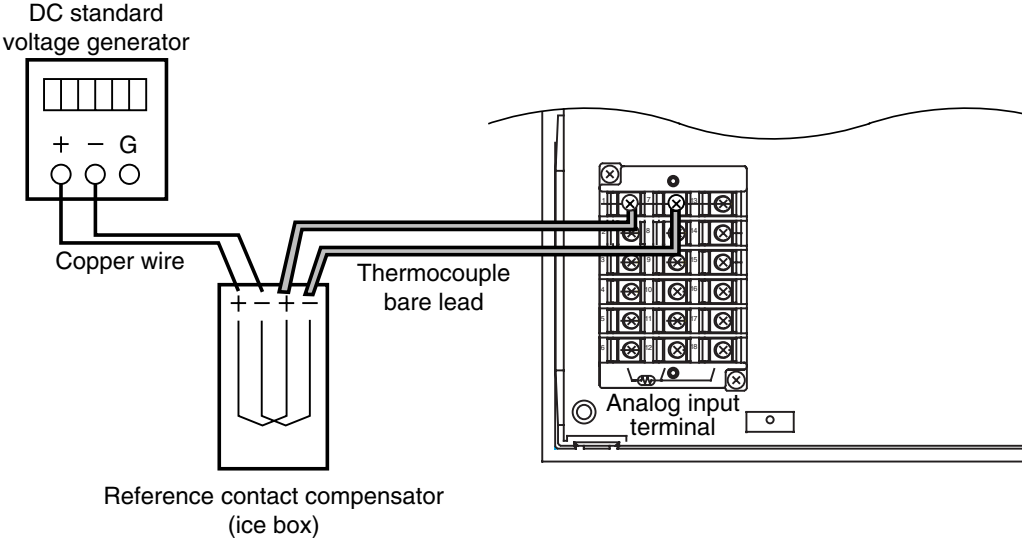

● When measuring a resistance temperature detector

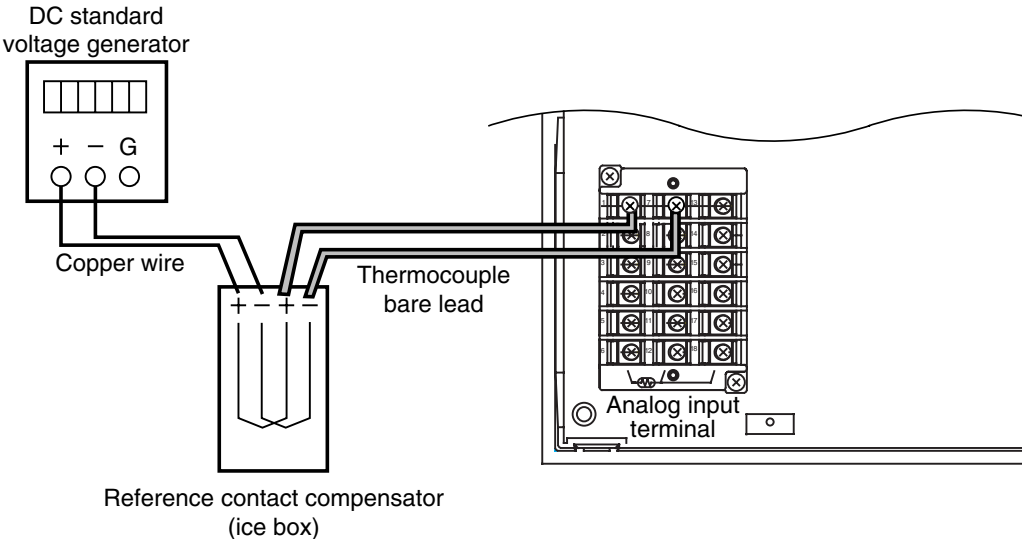

## 7 - 5 Adjusting the Dot Position

---

This section describes how to adjust the dot position on the chart.

This adjustment should be performed when the recording accuracy has drifted outside of the permissible accuracy range. The dot position is factory-adjusted, and normally need not be re-adjusted.

- The recording accuracy indicated in **Chapter 9. SPECIFICATIONS** assumes that ambient temperature, humidity and other environmental conditions are within their respective standard conditions.
- Otherwise, chart expansion/shrinkage must also be taken into consideration.

### ■ About Recording Accuracy

#### ● Recording accuracy

In PV axis (horizontal) direction: Display accuracy + ( $\pm 0.3\%$  of recording F.S.)

In time axis (vertical) direction:  $\pm 0.5\text{mm}$

#### ● Chart expansion/shrinkage (in horizontal direction)

- The chart expands about  $0.7\%$ F.S. when the ambient humidity changes from  $60\%$  to  $85\%$ RH.
- The chart shrinks about  $0.2\%$ F.S. when the ambient humidity changes from  $60\%$  to  $45\%$ RH.

### ■ About Standard Conditions

- Temperature:  $23\pm 2^\circ\text{C}$
- Humidity:  $60\pm 5\%$ RH
- Mounting: Horizontal

■ Procedure

The following describes the adjustment procedure for dot positions 0% and 100%:

- (1) Make sure that the standard environmental conditions described on the previous page are satisfied, and then turn the power OFF.
- (2) Draw out the chassis according to the procedure described on pages 7-3 and 7-4.
- (3) Switch the on-board mode selector pin P10 to “CAL” from “REC”.

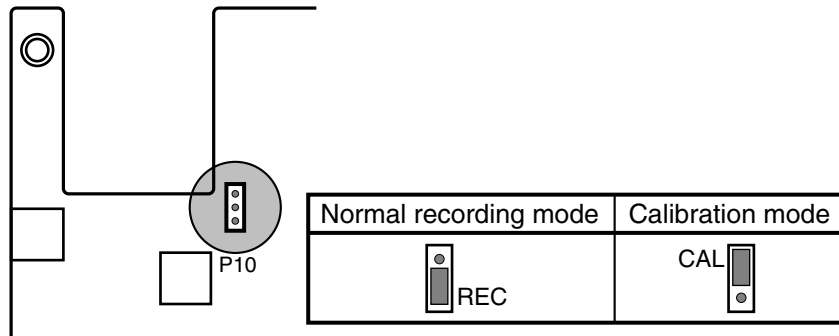

- (4) Install the chassis.
- (5) Turn the SRF206/212/224 ON with the **SET** and **RCD** keys held down simultaneously.

! Handling Precautions

Hold the keys down until “Adjust” is displayed. If “Adjust” is not displayed, turn the SRF206/212/224 OFF again, and repeat step (5).

- (6) Press the **DISP** key to display dot position adjustment item “14”.
- (7) Press the **SET** key to select the adjustment position.

To adjust the 0% dot position, select “1”, and to adjust the 100% dot position, select “2”.

The following example shows the display setup unit when 0% dot position adjustment is selected:

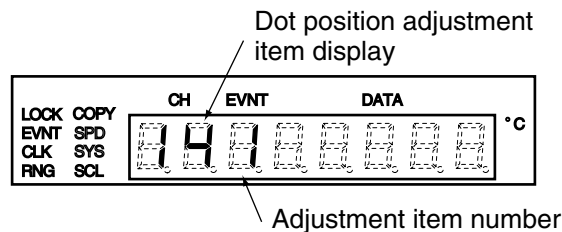

- (8) Press the **ENT** key to start the dot position adjustment. The DATA LED blinks for about 2s, and dot printing is started using the current dot position adjustment data.

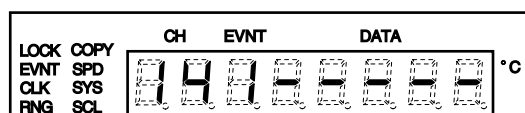

(9) Blinking of the DATA LEDs stops, and the current dot position adjustment value data is displayed.

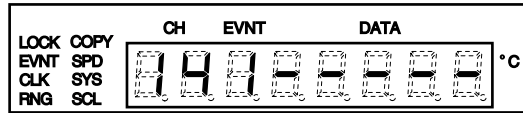

(10) Adjust the dot position using the ▲ / ▼ keys. (adjustment range: -10 to +10)

- ◇ Pressing the ▲ key moves the head position to the right. A value incremented by “1” is displayed as the adjustment data value.
- ◇ Pressing the ▼ key moves the head position to the left. A value decremented by “-1” is displayed as the adjustment data value.

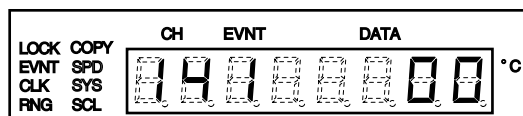

**! Handling Precautions**

To cancel adjustment of the dot position midway, press the **SET** key. This advances the adjustment item number without changing the numerical values.

To resume adjustment, return to step (2). To quit the adjustment, advance to step (13).

(11) After aligning the dot position to the 0% or 100% positions, press the **ENT** key to write the adjustment value data. The DATA LED blinks for about 2s, and dot printing is stopped.

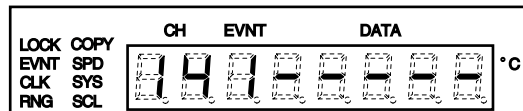

(12) When registration of adjustment data is completed, the display in step (7) is redisplayed.

(13) To quit dot position adjustment, draw out the chassis following the procedure in steps (1) and (2), and switch the on-board mode selector pin P10 to “REC” from “CAL”.

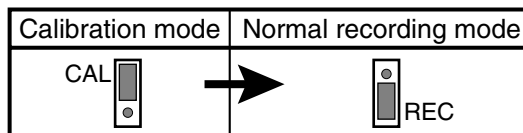

(14) Install the chassis.

(15) When the SRF206/212/224 is next turned ON, it starts up in the normal recording mode.

**! Handling Precautions**

If you enter the normal recording mode with the on-board mode selector pin P10 still set to “CAL”, alarm message “AL13” is generated. If this happens, switch pin P10 to “REC”.





# Chapter 8. TROUBLESHOOTING

## 8 - 1 Alarm Display and Descriptions

This recorder is provided with a self diagnostics function that inspects the functions at all times. If an error is detected, an alarm code is displayed on the display, and not in the configuration display.

If a function is judged to be in error, a predetermined operation according to the alarm type is carried out.

If two or more errors are judged to have occurred simultaneously, alarm codes are displayed successively from the lowest number alternating with regular display. To cancel display of an alarm code, turn the power OFF then back ON again unless otherwise mentioned. If an alarm code stays displayed even though a remedy has been carried out, contact us for repair.

**Display example (AL01)**



### ● Alarm display: diagnostic item

- ◇ Description of alarm
- Recorder operation
- ⇒ Remedy

### ◆ AL01: printer position

- ◇ The reset position of the wire dot head is checked to see if it can be detected.
- The alarm code is displayed, and recording stops. Operations except recording are continued.
- ⇒ Check to see if the chart or the chart holder is not touching the wire dot head.

### ◆ AL02: ribbon position

- ◇ The reset position of the ink ribbon cassette holder is checked to see if it can be detected.
- The alarm code is displayed, and recording stops. Operations except recording are continued.
- ⇒ Check to see if the ink ribbon is not entangled with the wire dot head.

### ◆ AL03: clock backup battery

- ◇ The clock backup battery is checked when the power is turned ON.
- The alarm code is displayed, and recording continues. At this time, the date and time are initialized to “2000/01/01, 00:00”. Storage of recording operation (recording ON/OFF) is forcibly set to “recording ON”, and recording is started by recording ON even if recording previously ended by recording OFF.
- ⇒ Replace the lithium battery.

### ◆ AL04: reference contact temperature

- ◇ The reference contact temperature range (-30°C to +80°C) is checked.
- The alarm code is displayed, and operation continues. At this time, either -30°C or +80°C is used as the reference contact temperature. So, data is not reliable.
- ⇒ Ask for repair.

◆ **AL05: A/D converter**

- ◇ A/D converter operation is checked.
- The alarm code is displayed, and operation continues. At this time, an unstable value is indicated as the PV value. So, data is not reliable.
- ⇒ Ask for repair.

◆ **AL06: reference voltage**

- ◇ The reference voltage A/D conversion value range is checked.
- The alarm code is displayed, and operation continues. At this time, design values are used for the reference voltage value. So, data is not reliable.
- ⇒ Ask for repair.

◆ **AL07: auto zero entry**

- ◇ The auto zero A/D conversion value range is checked.
- The alarm code is displayed, and operation continues. At this time, design values are use for the auto zero value. So, data is not reliable.
- ⇒ Ask for repair.

◆ **AL08: ROM**

- ◇ The checksum is verified over all areas when the power is turned ON.
- The alarm code is displayed, and all operations stop.
- ⇒ Ask for repair.

◆ **AL09: RAM**

- ◇ The RAM is checked when the power is turned ON.
- The alarm code is displayed, and all operations stop.
- ⇒ Ask for repair.

◆ **AL10: EEPROM**

- ◇ The EEPROM is checked when data is written.
- The alarm code is displayed, and operation continues. At this time, data in RAM is used as the data.
- ⇒ Ask for repair.

◆ **AL11: calibration data**

- ◇ The checksum of calibration data in EEPROM is verified when the power is turned ON.
- The alarm code is displayed, and all operations stop.
  
- ◇ During operation, the checksum is periodically verified. During an alarm, the data in EEPROM is copied to RAM, and is checked again.
- The alarm code is displayed, and operation continues. At this time, design values are used as calibration data.
- ⇒ Ask for repair.

---

**◆ AL 12: configuration data**

- ◇ A verify check is carried out on all range data when range data is written. During an alarm, data in RAM is copied to EEPROM, and the verify check is carried out on this data.
- The alarm code is displayed, and operation continues. At this time, data in RAM is used as range data.
- ⇒ Reset the configuration data. If this error reoccurs after carrying out the remedy, ask for repair.

**◆ AL 13: mode selector pin**

- ◇ If the normal mode is entered after the power is turned ON, the mode selector switch is read. If the calibration mode cannot be entered when the power is turned ON with the mode selector pin inserted in the calibration mode position, this is judged to be a diagnostics error.
- The alarm code is displayed, and operation continues.
- ⇒ Return the mode selector pin to the REC mode position.

**◆ AL 15: model No. information**

- ◇ When the normal mode is entered after the power is turned ON, a check is carried out to see if the mode No. information (number of dots, optional functions) preset to the recorder matches the hardware information. If this information does not match, this is judged to be an error.  
This alarm code is displayed when the option unit is added or dismantled without the change in the model number information.
- The alarm code is displayed, and operation continues. At this time, the model No. information preset to the recorder is used as the model No. information.
- ⇒ This error is sometimes remedied at the site. Contact your nearest dealer or agent.  
When an option unit is to be added, the model number information must be changed in accordance with the user's manual of new option unit.  
The alarm code will not be displayed after the power supply is turned on again.



**◆ No display: watchdog timer**

- ◇ When a time-out error occurs on the watchdog timer, this is judged to be a diagnostic error.
- The recorder restarts automatically.

## 8 - 2 Remediating Trouble

Trouble	Probable Cause	Remedy
No operation (e.g. display, recording)	Power is not being supplied to the main unit.	Check the wiring and power voltage, and supply the power correctly.
	The power switch on the main unit is OFF.	Set the power switch at the top right on the main unit to ON.
	The fuse has blown.	Remove the cause of the fuse blowing, and replace the fuse. (See page 7-5.)
	The chassis is not correctly inserted.	Correctly insert the chassis. (Note 1)

Note 1: A probable cause is a damaged connector on the driver board mounted on the chassis. Check this when the chassis is re-attached.

Trouble	Probable Cause	Remedy
Pressing the  key does not advance the display to PV value display.	The recording mode for all channels is set to "display/recording OFF".	Set the recording mode for the required channels.
"ALXX" is displayed on the display.	An error was discovered during self diagnostics.	Remedy by referring to pages 8-1 to 8-3.
Recording is not carried out even though PV value display is normal.	The recording mode for all channels is set to "display only".	Set the recording mode for the required number of channels.
	Recording is not ON.	Press the  key to start recording.
	The ink ribbon has reached the end of its life.	Replace with a new ink ribbon cassette. (See page 4-13.)
	The ink ribbon is not loaded.	Attach the ink ribbon cassette. (See page 4-4.)
	The ink ribbon is not passing along the correct path.	Pass the ink ribbon between the printer and chart. (See page 4-4.)
	The chart cassette is not loaded correctly.	Insert the chart cassette correctly as far as possible. (Note 2)
Incorrect recording color	The ink ribbon is not loaded correctly.	Replace with a new ink ribbon cassette. (See page 4-4.)
Faint recording color	The ink ribbon has reached the end of its life.	Replace with a new ink ribbon cassette. (See page 4-13.)
	The ink ribbon is not loaded correctly.	Press the  key to make sure that the ink ribbon feed knob turns and is correctly attached. (Note 2)
Chart is not the right one or printing is faint.	The ink ribbon is wound under the twisted condition.	Replace with a new ink ribbon cassette. (See page 4-13.)
Recording color periodically faint	The ink ribbon has been left for a long time in an open state, and has partially dried.	Replace with a new ink ribbon cassette. (See page 4-13.)
The chart is not being fed.	The chart is not loaded correctly.	Make sure that the chart holder and chart guide are correctly attached in place. Attach correctly if necessary.
The chart has come loose from the sprockets.	The chart is not loaded correctly.	Make sure that the chart holder and chart guide are correctly attached in place. Attach correctly if necessary. If the problem is not solved, turn the power off and then on again.

Note 2: Pulling the ink ribbon out of the ink ribbon cassette with excessive force may damage the components inside the ink ribbon cassette. Slowly turn the ink ribbon feed knob to take up any slack on an ink ribbon that is protruding too much.

Trouble	Probable Cause	Remedy
Trends and characters sometimes smudge or print heavily.	The chart cassette is not loaded correctly.	Insert the chart cassette correctly as far as possible. (Note 3)
Trends became discontinuous.	Noises from sensors or signal transmitter were transmitted through input wires.	Check the noise sources and attenuate the noise level.
	Chart holder or chart cassette are not correctly set, thus, hindering the movement of printer.	Correctly set the parts in place.
	Some soiled moving mechanism of printer is hindering the printing.	The moving mechanism such as is shaft should be cleaned.
Characters can not made out.	Chart holder or chart cassette are not correctly set, thus, hindering the movement of printer.	Correctly set the parts in place.
	Some soiled moving mechanism of printer is hindering the printing.	The moving mechanism such as shaft should be cleaned.
"OL", "-OL", "OF" or "-OF" is displayed	An excessive voltage is being input.	Make sure that the signal voltage is correct. Enter the correct signal.
		Make sure that the signal voltage is correct. Enter the correct range code.
		Check the polarities of the input terminals, and wire correctly if necessary.
	The wiring or sensor is broken.	Check the wiring from the sensor for breakages. Repair the sensor.
		Check the wiring from the signal oscillator for breakages. Repair the oscillator.
	The sensor or signal generator is malfunctioning.	Make sure that sensor is not malfunctioning. Repair the sensor.
		Make sure that the signal generated is not malfunctioning. Repair the signal generator.
	The input impedance of equipment connected in parallel to the recorder has dropped.	Make sure that sensor is not malfunctioning. Repair the sensor.
Make sure that the signal generated is not malfunctioning. Repair the signal generator.		
PV values using engineering scaling remain fixed values in spite of the input signal.	The engineering range upper limit value is set to the same value as its lower limit value.	Set the correct engineering range. (See page 6-4.)
The PV display shows an error with the actual PV value.	The range code setting does not match the sensor.	Set the correct range code. (See page 6-4.)
	The PV bias is inappropriate.	Set the appropriate PV bias. To disable, set to "0" (zero). (See page 6-4.)
Recording is 0% or less or 100% or more even though the PV display is correct.	The scale setting is inappropriate.	Set the scale matched to the input. (See page 6-5.)
	The scale upper limit value is set to the same value as its lower limit value.	Set the correct scale. (See page 6-5.)
Trend is stepped.	The scale span is far smaller than the resolution.	Set the scale as required. (See page 6-5.)

Note 3: The chart cassette may not go in further in case of the chart latch not being completely in place.

## Chapter 8. TROUBLESHOOTING

Trouble	Probable Cause	Remedy
Pressing the <b>ENT</b> key in the configuration mode cannot set data.	Configuration is locked.	Cancel configuration lock in the system setup. (See page 6-3.)
	An attempt was made to enter illegal data.	Enter data in the correct entry range.
Pressing the <b>SET</b> key does not enter the range or scale setting mode.	The menu level setting is "0".	Set the menu level setting. (See page 6-3.)
The recorder does not enter the event setting value screen.	The event type setting is set to "event OFF".	Correct the event type setting. (See page 6-2.)
The setting values of the relay output No. or open collector output No. does not light.	The option unit is malfunctioning.	Repair
Events are not recorded on the chart.	The event recording ON/OFF setting is set to "event recording OFF".	Set the event recording ON/OFF setting to "event recording ON." (See page 6-2.)
The event switches ON/OFF continuously.	The event differential is too small.	Set the event differential to the appropriate value. (See page 6-2.)
Characters (shedule demand, message) are not printed on charts.	The chart feed speed is set to 4mm/h or less or 121mm/h or more. Printing conflict occurred.	Set (See page 6-2.) Check the details of printing conflict.
PV values during demand printing or tabulation printing are all printed as "-----".	The recording mode of all channels is set to "display/recording OFF".	Set the recording mode for the required channels.
The recorder ID No. is not printed.	The recorder ID No. setting is "0".	Set the recorder ID No. to number other than "0" (zero). (See page 6-3.)
The time is not recorded.	The time recording ON/OFF setting is OFF.	Set the time recording ON/OFF setting to ON. (See page 6-3.)
Scale is not recorded.	The scale recording ON/OFF setting is OFF.	Set the scale recording ON/OFF setting to ON. (See page 6-3.)
The recording color does not match the tag plate.	The recording color selection setting does not match the tag plate.	Match the recording color selection to the tag plate. (See page 6-3.)
		Obtain a tag plate matched to the recording color selection. (See page 1-4.)
Schedule demand is not printed.	The time setting interval is too short and cannot be printed.	Set the time setting to a wider value. (See page 6-5.)
		Decrease the number of demand printing. (See page 6-5.)
		Set the chart feed speed to a higher value. (See page 6-2.)
	The number of schedule demand ON/OFF settings is less than the time setting.	Match the number of schedule demand ON/OFF settings to the number of schedule demand time settings in use.
	The schedule demand printing time is not set to "recording ON".	Set to the recording ON mode before the schedule demand printing time.
The loader cannot be connected.	The cable is not connected or is broken.	Check connections, and replace cables.

Trouble	Probable Cause	Remedy
CPL communications is not possible.	The device address is set to "0".	Set the device address to an appropriate value other than "0". (See page 6-3.)
	The communications method of the recorder does not match the setting of the master.	Match the communications method between this recorder and the master. (See page 6-3.)
	Inappropriate communications cable	Use an appropriate cable.
	Incorrect communications wiring	Rewire correctly. (See pages 3-12, 3-13.)
	Incorrect protocol	Change to the appropriate protocol.
Data from the master station cannot be written by CPL communications.	Communications access rights are set to "read only."	Set the communications access rights to "read/write" as necessary. (See page 6-3.)





# Chapter 9. SPECIFICATIONS

## 9 - 1 Specifications

### ■ General Specifications

Memory protection	Setup data	EEPROM
	Clock backup	Lithium cell: CR2430
Insulation resistance	Min. 20MΩ across each terminal and GND terminal (by 500Vdc megger)	
Dielectric strength	Power supply, relay output, open collector output (leak current 5mA max.): Across power terminal and GND terminal: 1500Vac 50/60Hz for 1min Across relay output terminal and GND terminal: 1500Vac 50/60Hz for 1min Across open collector output terminal and GND terminal: 500Vac 50/60Hz for 1min Input (leak current 2mA max.) Across measurement input terminal and GND terminal: 1000Vac 50/60Hz for 1min Across measurement input terminals: 500Vac 50/60Hz for 1min (excluding RTD input) Across external switch input terminal and GND terminal: 500Vac 50/60Hz for 1min Across communications terminal and GND terminal: 500Vac 50/60Hz for 1min	
Induction resistance	Common mode rejection rate: 120dB (50/60Hz±0.1Hz, input impedance 500Ω, across terminals and ground) Normal mode rejection rate: 40dB (50/60Hz±0.1Hz)	
Standard conditions	Temperature	23±2°C
	Humidity	60±5%RH
	Voltage fluctuation	±1%
	Frequency fluctuation	±1%
	Vibration, noise, surge voltage	Not allowed
	Influence from other equipment	Not allowed
	Mounting	Horizontal
Operating conditions	Ambient temperature	0 to 50°C
	Ambient humidity	30 to 90%RH (condensation not allowed)
	Power voltage	90 to 250Vac
	Power supply frequency	±5% of rated power frequency
	Vibration resistance	0.98m/s <sup>2</sup> (0 to 100Hz)
	Mounting orientation	0 to 30° bottom rear angle from horizontal position, 0 to 3° top rear angle from horizontal position, other directions 10°
	Altitude	Max. 2000m
Transportation/storage conditions	Ambient temperature	-20 to +60°C (-10 to +60°C for ink ribbon. At -20 to -10°C, only ink ribbon must be stored separately.)
	Ambient humidity	10 to 95%RH (condensation not allowed)
	Shock resistance	294m/s <sup>2</sup> (continuously for 11ms max.)
	Vibration resistance	4.9m/s <sup>2</sup> max. (0 to 100Hz)
Rated power voltage	100 to 240Vac, 50/60Hz	
Power consumption	Approx. 50VA (100VA max.)	
Rush current	Approx. 25A (for 10ms max.) at Power voltage 100Vac Approx. 45A (for 10ms max.) at Power voltage 200Vac	
Material	Case	Steel plate
	Door frame	Modified PPE (m-PPE-GF30)
	Door window	Acryl (PMMA)
Color	Case	Frosted gray (DIC554 or equivalent)
	Door frame	Surface matte gray (DIC554 or equivalent)
Mass	Approx. 7 to 8kg (Varies according to basic model No. and optional functions.)	
Mounting	Panel mount	
Applicable standards	EN61010-1, EN61326	
Warm up time	At least 60 minutes	

■ Performance Specifications

Input	Input type	<p>DC voltage: -20 to +20mV, -40 to +40mV, -60 to 60mV, -200 to +200mV, -2 to +2V, -5 to +5V, 0 to 10V</p> <p>Thermocouple: R,S,B,K,E,J,T,N (JIS C1602-1995) WRe0-26 (ASTM E1751) WRe5-26 (ASTM E988-90) PR40-20 (Johnson Matthey Data) PL II(Engelhard Industries Data (IPTS68)) Ni-NiMo (General Electric Data)</p> <p>Resistance temperature detector (RTD): Pt100,JPt100 (JIS C1604-1989) JPt50 (JIS C1604-1981) Ni508 (Yamatake Data)</p> <p>ON/OFF input</p> <p>Communication input  Refer page 9-6</p> <p>Note 1: In the case of DC current (4 to 20mAdc), attach a converter resistor(sold separately, catalog No.81446642-001 or 81401325), and convert to 1 to 5V to input.</p>
	Number of input channels	6/12/24
	Input measurement cycle	6/12 models: 15s, 24 model: 30s (30s regardless of number of measurement points)
	Input impedance	DC voltage ( $\pm 2V$ range max.), thermocouple input: 10M $\Omega$ min. DC voltage ( $\pm 5V$ range min.) : 1M $\Omega$ min.
	Allowable wiring resistance	DC voltage, thermocouple input (input wiring resistor): 2k $\Omega$ max. RTD input (input wiring resistor) : 10 $\Omega$ max. (per line. However, resistance of three lines must be the same.)
	Burnout	Thermocouple input: one of upscale/downscale OFF can be selected for each channel (burnout condition: 10M $\Omega$ min.)
	Input bias current	DC voltage ( $\pm 2V$ range max.), thermocouple input: $\pm 100nA$ max. DC voltage ( $\pm 5V$ range min.) : $\pm 1\mu A$ max. However, current must be $\pm 200nA$ max. when setting burnout for thermocouple input.
	Measuring current	RTD input: Approx. 1mA
	Permissible input voltage range	Outside RTD range: -7 to +11Vdc RTD range: -5 to +5Vdc
	PV bias	Can be set to each channel in range -19999 to +29999 Unit (engineering unit including decimal point).
	Linear scaling	Display and recording is possible at actual unit (engineering unit) at linear scaling range DC voltage (range codes 00 to 06).
	Direct-reading range	mV or V values can be read directly with linear scaling set to OFF during input voltage direct-reading range and current/voltage (range codes 10 to 16).
	Digital input trend	Digital input trends are printed for channels whose input range type is set to ON/OFF input range.
	Communications input trend*	Written data is printed as measurement the value by communications for channels whose input range type is set to communications input.
	Measurement/calculation method	PV value, inter-channel deviation, deviation from fixed value, functional operation (integration, F value, relative humidity)
	Measurement range	DC voltage input: Any measurement range (upper/lower limit values) can be set for each of the measurement ranges.
	Segment table offset	Up to 14 segments tables can be set, and X (input) can be converted to Y (output). Three segment tables can be set.
	Engineering range	DC voltage input: The engineering range (upper/lower limit value, decimal point position and unit) can be set within the range -19999 to +29999.
	Recording scale	Any recording scale (including reverse scaling) can be set for each channel within the range -19999 to +29999.
	Reference contact compensation	Thermocouple input: Compensation can be set ON/OFF for all channels (not independently). When compensation is set to OFF, a reference contact compensation unit (such as an ice box) must be provided externally.

\* Communications input trend is supported on models that support the communications function.

Input	Intrinsically safe explosion-proof system	100Vac is used as the lamp power supply on models with chart illumination lamp. So, an intrinsically safe explosion-proof system cannot be configured. When an intrinsically safe explosion-proof system is required, select a model without the chart illumination lamp, and connect a Zener barrier externally. If uneven resistance from the Zener barrier causes a temperature display error to occur, compensate for this by the PV bias. As the input wiring resistance exceeds 10Ω, the accuracy compensation on page 9-7 cannot be applied.							
Display	Digital display	Display method	Red and green 8-digit, 7-segment LED and 2 green LEDs for units (One of these is a 5-digit, green LED for displaying measurement values.)						
		Display cycle	4s/measurement point						
		Display information	<ul style="list-style-type: none"> <li>• Measurement values</li> <li>• Channel No.</li> <li>• Alarm display</li> <li>• Date</li> <li>• Time (h:min)</li> <li>• Chart feed speed</li> <li>• Other configuration data</li> </ul>						
	Lamp display	Display information	<ul style="list-style-type: none"> <li>• Lights during recording and event occurrence</li> <li>• Lights and displays configuration and operation mode information</li> </ul>						
Recorder	Recording method	Dot recording	Wire dot + ink ribbon (6 colors)						
		Dot size	Approx. 0.5mm						
		Trend recording cycle	6/12 models: 15s 24 models: 30s (fixed cycle regardless of number of measurement inputs)						
		Recording color	Trend	Two types can be selected and set (turn power ON to enable)					
			Channel	1, 7, 13, 19	2, 8, 14, 20	3, 9, 15, 21	4, 10, 16, 22	5, 11, 17, 23	6, 12, 18, 24
			Standard	Purple	Red	Green	Blue	Brown	Black
			DIN	Purple	Red	Black	Green	Blue	Brown
			Scale	Same color as trend color of each channel					
			Tabulation recording	Same color as trend color of each channel					
			Time printing	PV value: Same color as trend color of each channel Time: Purple					
			Event	Occurrence: red Reset: Blue					
			Channel No.	Same color as trend color of each channel					
		Demand	PV value: Same color as trend color of each channel Time: Purple						
	Message	Purple							
	Other	Purple							
	Character structure	Dot matrix	7 (V) x 5 (H)						
	Character recording	Recording at chart feed speed 5 to 120mm/h max.							
	Chart	Shape	Folding type						
		Eff. recording width	-1.8 to +181.8mm of calibration position (0%)						
		Total length	20m (standard paper), 16m (clean paper)						
Replacement warning mark		Warning marks are output at 10cm intervals from 60cm from the end of the chart.							
Chart feed speed		1 to 480mm/h, adjustable in 1mm/h steps							
Trend recording resolution		0.1mm							
Recording accuracy (excluding chart shrinkage/elongation)		PV axis: (Accuracy indicated in page 9-7) + (±0.3% of recording full scale) Time axis: ±0.1% max. (when chart is fed continuously for 1000mm or more)							
[Reference]		Chart shrinkage/elongation: When the ambient humidity has changed from 60% to 85%RH: → Chart stretches by approx. 0.7%FS. When the ambient humidity has changed from 60% to 45%RH → Chart shrinks by approx. 0.2%FS.							
Display/recording mode		One of the following four modes can be selected and set for each channel: • Display/recording OFF • Display only • Display/recording ON • Digital input-dependent							

Recording format	Trend recording	Trend	• PV value (analog) • Channel No.																			
		Scale printing	• Marker/time (h:min)/date/tag/unit/scale upper- and lower-limit values Or, • Marker/time (h:min)/chart feed speed/tag/unit/scale upper- and lower-limit values																			
		Event	• Marker (on trend) • Channel No./time (h:min)/event No./relay No./state (occurrence/reset) When a state occurs (is reset) before printing has finished, the next 24 items are memorized and printed.																			
	Trend + tabulation recording	Trend	• PV value (analog) • Channel No.																			
		Scale printing	• Marker/time (h:min)/date/tag/unit/scale upper- and lower-limit values Or, • Marker/time (h:min)/chart feed speed/tag/unit/scale upper- and lower-limit values																			
		Tabulation	<ul style="list-style-type: none"> <li>• PV value</li> <li>6-dot model: 1 row, 6 columns</li> <li>12-dot model: 2 rows, 6 columns</li> <li>24-dot model: 4 rows, 6 columns</li> <li>Tabulation is carried out after printing of the scale.</li> <li>• Tabulation Cycle</li> </ul> <table border="1" style="width: 100%; border-collapse: collapse;"> <tr> <td style="width: 12.5%;">Chart feed speed (mm/h)</td> <td style="width: 12.5%;">1 to 4</td> <td style="width: 12.5%;">5 to 10</td> <td style="width: 12.5%;">11 to 20</td> <td style="width: 12.5%;">21 to 40</td> <td style="width: 12.5%;">41 to 120</td> <td style="width: 12.5%;">121 to 480</td> </tr> <tr> <td>Print cycle (time)</td> <td>No printing</td> <td>12</td> <td>4</td> <td>2</td> <td>1</td> <td>No printing</td> </tr> </table>						Chart feed speed (mm/h)	1 to 4	5 to 10	11 to 20	21 to 40	41 to 120	121 to 480	Print cycle (time)	No printing	12	4	2	1	No printing
		Chart feed speed (mm/h)	1 to 4	5 to 10	11 to 20	21 to 40	41 to 120	121 to 480														
	Print cycle (time)	No printing	12	4	2	1	No printing															
	Event	• Marker (on trend) • Channel No./time (h:min)/event No./relay No./state (occurrence/reset) When a state occurs (is reset) before printing has finished, the next 24 items are memorized and printed.																				
	Trend + schedule demand	Trend	• PV value (analog) • Channel No.																			
		Scale printing	• Marker/time (h:min)/date/tag/unit/scale upper- and lower-limit values Or, • Marker/time (h:min)/chart feed speed/tag/unit/scale upper- and lower-limit values																			
		Schedule demand	<ul style="list-style-type: none"> <li>• Time (h:min)/PV value</li> <li>6-dot model: 1 row, 6 columns</li> <li>12-dot model: 2 rows, 6 columns</li> <li>24-dot model: 4 rows, 6 columns</li> <li>Up to eight times can be set.</li> </ul>																			
		Event	• Marker (on trend) • Channel No./time (h:min)/event No./relay No./state (occurrence/reset) When a state occurs (is reset) before printing has finished, the next 24 items are memorized and printed.																			
	Fixed interval tabulation	Tabulation is carried out at a preselected fixed interval. Trend recording is not carried out, and only printing is carried out.																				
Fixed time tabulation	Tabulation is carried once at the start of printing, and carried out from then on at a preselected time.																					
List printing	<ul style="list-style-type: none"> <li>• Print function lists: Parameters are printed out for each function categorized into four categories</li> <li>• Print all lists: All parameters set in the configuration are printed out. A 4-item function list is printed out continuously.</li> <li>• Print specified lists: Chart feed speed, range code, scale, unit, event setting values, etc.</li> </ul>																					
Communication list printing	Any prepared lists (within 85 characters x 3 lines) can be printed out as a list on the recording paper by a loader or communications.																					

Event	Setting	Number of set events	Four events can be set for each channel.	
		Setting range	-19999 to +29999 (Decimal point position varies according to range.)	
		Differential	0 to 29999 (Decimal point position varies according to range.)	
	Action	<p>Event action is carried out even while recording has stopped (RCD OFF).</p> <p>OFF: Event action stopped</p> <p>LOW (measurement value lower limit alarm): Action when the PV and deviation values are at the event setup value or less</p> <p>HIGH (measurement value upper limit alarm): Action when the PV and deviation values are at the event setup value or more</p>		
	Action result	Recording	<ul style="list-style-type: none"> <li>• Channel No.</li> <li>• Event occurrence/reset</li> <li>• Event state</li> <li>• Relay output number (w/ event option)</li> </ul>	
		Display	<ul style="list-style-type: none"> <li>• Event state and measurement value when an event occurs</li> <li>• Event occurrence/reset state on other channels</li> </ul>	
		Buffer	<ul style="list-style-type: none"> <li>• Up to 24 recording actions are memorized. (These are cleared when the power or recording are turned OFF.)</li> </ul>	
		Output	Relay output, open collector output or output to internal contact inputs possible	
	Optional functions	External switch inputs	Number of inputs	4/8/12
			Functions	<p>Functions operate by assigning the following:</p> <ul style="list-style-type: none"> <li>• Recording start/stop</li> <li>• Print on demand</li> <li>• Print all lists</li> <li>• Print specified lists</li> <li>• Print communications lists</li> <li>• Chart feed</li> <li>• Chart feed speed/scale selection</li> <li>• Clear batch counter</li> <li>• Reset total</li> <li>• Print messages</li> <li>• Recording mode selection</li> <li>• BIN code entry</li> </ul>
Contact hold time			500ms min.	
Switch type			Dry contact or open collector (current sink to common)	
Allowable open collector ON residual voltage			0.5V max. (under recommended operating conditions)	
Allowable open collector OFF leakage current			0.1mA max. (under recommended operating conditions)	
Open voltage			Approx. 5V	
Short-circuit current			Approx. 6mA	
Event outputs			Number of outputs	6/12
		Output action	Four event actions (max. 96 actions) preset to each channel can be freely combined to output OR or AND.	
		Output type	Transfer contact (NC, NO contact), both normal and reverse relay excitation possible.	
		Contact rating	250Vac 3A (resistive load) 30Vdc 3A (resistive load) Min. load 5Vdc 10mA, 24Vdc 50mA	
		Electrical life	100,000 operations (resistive load)	
		Event re-output	When two or more event outputs are linked by OR action, the events can be output again when a new event occurs.	
Open collector outputs		Number of outputs	12 + 3 (special output)	
		Output action	Four event actions preset to each channel can be freely combined for OR and AND output	
		Special outputs	<ul style="list-style-type: none"> <li>• ON during recording</li> <li>• ON at power ON</li> <li>• ON when an alarm occurs (AL01 to AL15)</li> </ul>	
		Load drive power voltage	10 to 29Vdc (including power ripple)	
		Max. load current	70mA max. (at normal operating conditions)	
		OFF leakage current	0.1mA max. (at normal operation, load drive power voltage range)	
		ON residual voltage	1.6V max. (max. output current at normal operation, load drive power voltage range)	
		Event re-output	When two or more event outputs are linked by OR operation, the events can be output again when a new event occurs.	

Chapter 9. SPECIFICATIONS

Optional functions	Chart illumination lamp	Cold cathode fluorescent light			
	Communications	Standard	Standard	RS-232C	RS-485
			Number of signal lines	3 (including SG)	5 (including SG)
			Transmission distance	15m max.	300m max.
		Protocol	Standard	Yamatake CPL communications	Yamatake CPL communications
			Network	1:1	Multi-drop (max. 31 nodes)
			Function	Slave station function	Slave station function
			Master station	Not specified	Not specified
		Communications system	Synchronization	Start-stop synchronization	Start-stop synchronization
			Communications flow	Half duplex	Half duplex
			Transmission speed	4800, 9600bps	4800, 9600bps
			Data length	8bits	8bits
			Parity	Even parity, no parity	Even parity, no parity
		Stop bit	1, 2	1, 2	

## 9 - 2 Input Types, Ranges and Display Accuracy

Input			Range		Display Accuracy (rdg refers to absolute value of indication value)	Resolution	
Type	Symbol	Code	mV/V input	mV/V indication range			
DC voltage	mV	0	±20mV	-19999 to +29999	± (0.2% of rdg+3 digits)	10µV	
		1	±40mV	-19999 to +29999	± (0.2% of rdg+2 digits)	10µV	
		2	±60mV	-19999 to +29999	± (0.2% of rdg+2 digits)	10µV	
		3	±200mV	-19999 to +29999	± (0.2% of rdg+2 digits)	100µV	
	V	4	±2V	-19999 to +29999	± (0.2% of rdg+2 digits)	1mV	
		5	±5V	-19999 to +29999	± (0.2% of rdg+2 digits)	1mV	
		6	0 to 10V	-19999 to +29999	± (0.2% of rdg+2 digits)	1mV	
	mV	10	±20mV	±20.00mV	± (0.2% of rdg+3 digits)	10µV	
		11	±40mV	±40.00mV	± (0.2% of rdg+2 digits)	10µV	
		12	±60mV	±60.00mV	± (0.2% of rdg+2 digits)	10µV	
		13	±200mV	±200.00mV	± (0.2% of rdg+2 digits)	100µV	
	V	14	±2V	±2.000V	± (0.2% of rdg+2 digits)	1mV	
		15	±5V	±5.000V	± (0.2% of rdg+2 digits)	1mV	
		16	0 to 10V	0.000 to 10.000V	± (0.2% of rdg+2 digits)	1mV	
	Type	Symbol	Code	°C Range		Display Accuracy	Resolution
	Thermocouple (Note 1)	R	20	0.0 to 1760.0°C	0 to less than 100°C	±3.7°C	0.2°C
S		21	100 to less than 300°C		±1.5°C	0.2°C	
				300°C min.	± (0.15% of rdg+1°C)	0.2°C	
B		22	0.0 to 1820.0°C	Less than 400°C	±50°C	Not specified	
				400 to less than 600°C	±3°C	0.3°C	
				600°C min.	± (0.15% of rdg+1°C)	0.2°C	
K		23	-200.0 to +1370.0°C	-200 to less than -100°C	± (0.15% of rdg+1.5°C)	0.2°C	
				-100°C min.	± (0.15% of rdg+0.9°C)	0.2°C	
E		24	-200.0 to +800.0°C	-200 to less than -100°C	± (0.15% of rdg+1°C)	0.2°C	
				-100°C min.	± (0.15% of rdg+0.6°C)	0.2°C	
J		25	-200.0 to +1100.0°C	-200 to less than -100°C	± (0.15% of rdg+1.1°C)	0.2°C	
				-100°C min.	± (0.15% of rdg+0.7°C)	0.2°C	
T		26	-200.0 to +400.0°C	-200 to less than -100°C	± (0.15% of rdg+1°C)	0.2°C	
				-100°C min.	± (0.15% of rdg+0.6°C)	0.2°C	
N	27	0.0 to 1300.0°C	Entire range	± (0.15% of rdg+1°C)	0.2°C		
WRe0-26	28	0.0 to 2320.0°C	0 to less than 300°C	± (0.15% of rdg+10°C)	1.1°C		
			300 to less than 600°C	± (0.15% of rdg+1.5°C)	0.2°C		
			600°C min.	± (0.15% of rdg+1°C)	0.2°C		
WRe5-26	29	0.0 to 2320.0°C	0 to less than 300°C	± (0.15% of rdg+1.5°C)	0.2°C		
			300°C min.	± (0.15% of rdg+1°C)	0.2°C		
PR40-20	30	0.0 to 1880.0°C	0 to less than 500°C	±40°C	2.2°C		
			500 to less than 900°C	±12°C	0.7°C		
			900 to less than 1500°C	± (0.3% of rdg+6°C)	0.4°C		
			1500°C min.	± (0.3% of rdg+3.5°C)	0.2°C		
PLII	31	0.0 to 1290.0°C	Entire range	± (0.15% of rdg+0.7°C)	0.2°C		
Ni-Ni•Mo	32	0.0 to 1200.0°C	Entire range	± (0.15% of rdg+0.7°C)	0.2°C		
Resistance temperature detector (RTD)	Pt100	40	-200.0 to +550.0°C	Entire range	± (0.15% of rdg+0.6°C)	0.2°C	
	JPt100	41	-200.0 to +550.0 °C	Entire range	± (0.15% of rdg+0.6°C)	0.2°C	
	JPt50	42	-200.0 to +550.0°C	Entire range	± (0.3% of rdg+1.2°C)	0.4%	
	Ni508	43	-50.0 to +150.0°C	Entire range	± (0.15% of rdg+0.6°C)	0.2%	



Type	Symbol	Code	°F Range	Display Accuracy		Resolution
Thermocouple (Note 1)	R	50	32 to 3200°F	32 to less than 212°F	±8°F	1°F
	S	51		212 to less than 572°F	±4°F	1°F
				572°F min.	± (0.15% of rdg+3°F)	1°F
	B	52	32 to 3308°F	Less than 752°F	±90°F	Not specified
				752 to less than 1112°F	±6°F	2°F
				1112°F min.	± (0.15% of rdg+3°F)	1°F
	K	53	-328 to +2498°F	-328 to less than -148°F	± (0.15% of rdg+4°F)	1°F
				-148°F min.	± (0.15% of rdg+3°F)	1°F
	E	54	-328 to +1472°F	-328 to less than -148°F	± (0.15% of rdg+3°F)	1°F
				-148°F min.	± (0.15% of rdg+2°F)	1°F
	J	55	-328 to +2012°F	-328 to less than -148°F	± (0.15% of rdg+3°F)	1°F
				-148°F min.	± (0.15% of rdg+2°F)	1°F
T	56	-328 to +752°F	-328 to less than -148°F	± (0.15% of rdg+3°F)	1°F	
			-148°F min.	± (0.15% of rdg+2°F)	1°F	
N	57	32 to 2372°F	Entire range	± (0.15% of rdg+3°F)	1°F	
WRe0-26	58	32 to 4208°F	32 to less than 572°F	± (0.15% of rdg+19°F)	3°F	
			572 to less than 1112°F	± (0.15% of rdg+4°F)	1°F	
			1112°F min.	± (0.15% of rdg+3°F)	1°F	
WRe5-26	59	32 to 4208°F	32 to less than 572°F	± (0.15% of rdg+4°F)	1°F	
			572°F min.	± (0.15% of rdg+3°F)	1°F	
PR40-20	60	32 to 3416°F	32 to less than 932°F	±73°F	5°F	
			932 to less than 1652°F	±23°F	2°F	
			1652 to less than 2732°F	± (0.3% of rdg+12°F)	2°F	
			2732°F min.	± (0.3% of rdg+7°F)	1°F	
PLII	61	32 to 2354°F	Entire range	± (0.15% of rdg+2°F)	1°F	
Ni-Ni•Mo	62	32 to 2192°F	Entire range	± (0.15% of rdg+2°F)	1°F	
Resistance temperature detector (RTD)	Pt100	70	-328.0 to +1202.0°F	Entire range	± (0.15% of rdg+1.2°F)	0.5°F
	JPt100	71	-328.0 to +1022.0°F	Entire range	± (0.15% of rdg+1.2°F)	0.5°F
	JPt50	72	-328.0 to +1022.0°F	Entire range	± (0.3% of rdg+2.4°F)	1.0°F
	Ni508	73	-58.0 to +302.0°F	Entire range	± (0.15% of rdg+1.2°F)	0.5°F
Communications input (Note 2)		80 to 87	-19999 to +29999	—	1U	
ON/OFF signal (Note 3)		90	—	—	1U	

Type	Code	Range	Resolution
Communication input (note 2)	80 to 87	-19999 to +29999	1U
ON/OFF input (note 3)	90	—	1U

(Note 1) Display accuracy does not include reference contact compensation accuracy. The final display accuracy, when reference contact compensation is ON (factory setting), is obtained by adding the following reference contact compensation accuracy to the display accuracy in the tables:

Reference contact compensation accuracy

- Type: K, E, J, T, N, Ni-Ni•Mo, PLII: ±0.5°C/±1°F

Note that the reference contact compensation accuracy is as follows at low temperatures:

At K, E, J, T input -100°C/-148°F or less: ±1°C/±2°F

- Type: R, S, B, WRe0-26, WRe5-26: ±1°C/±2°F
- Type: PR40-20: ±2°C/±4°F

(Note 2) The data that is written to a specific address (see Communications Address Table) by communication is processed as PV values.

(Note 3) The data that is specified by the following sub-code Nos. is processed as digital signals.

Sub Code No.	Digital Data Acquisition Destination	Supplementary Explanation
01 to 12	Relay outputs No.1 to No.12	These can be specified regardless of actual digital input or output. However, if an unmounted digital input is specified, the setting is fixed at OFF.
13 to 24	Open collector outputs No.1 to No.12	
31 to 42	External switch inputs No.1 to No.12	
51 to 62	Internal contact inputs No.1 to No.12	

# 9 - 3 External Dimensions

(unit: mm)

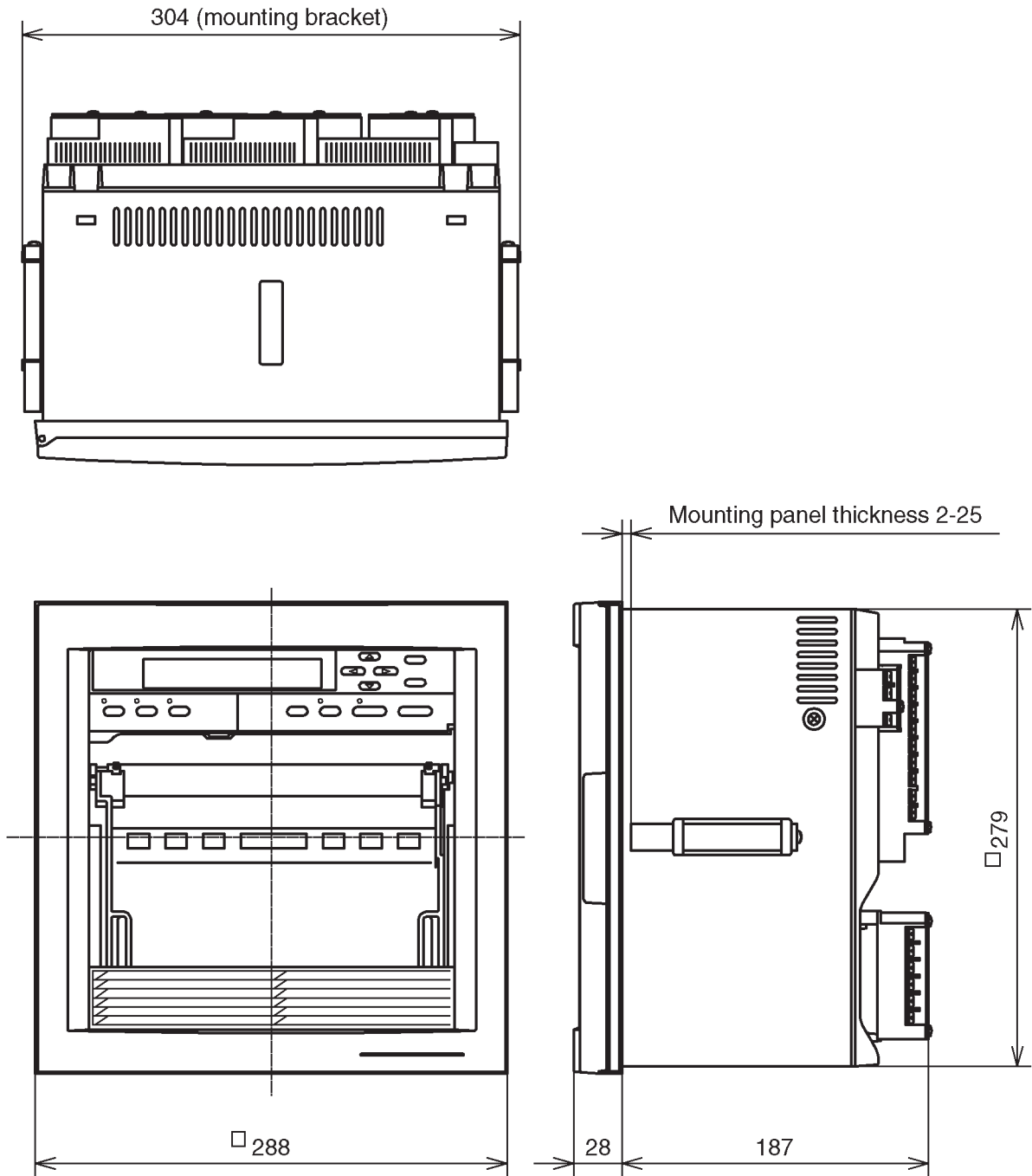



# APPENDIX

## Customer Setup Sheets

---

### ■ Contents

● Range code .....	.App.-2
● Calculation setup .....	.App.-2
● Scale setup .....	.App.-4
● Event setup .....	.App.-4
● System setup .....	.App.-6
● Chart feed speed setup .....	.App.-6
● Schedule demand setup .....	.App.-8
● Message setup .....	.App.-8
● User function 1, 2 keys setup .....	.App.-10
● Extended setup .....	.App.-12
● External switch input setup .....	.App.-12
● Internal contact input setup .....	.App.-14
● Relay output setup .....	.App.-14
● Open collector output setup .....	.App.-16
● Segment table 1 setup .....	.App.-18
● Segment table 1 setup .....	.App.-18
● Segment table 2 setup .....	.App.-20
● Segment table 2 setup .....	.App.-20
● Segment table 3 setup .....	.App.-22
● Segment table 3 setup .....	.App.-22

### ■ How to Use the User Setup Sheets

The left page of a user setup sheet shows the setup details, and the right page the user setup entry fields.

We recommend using a copy made of the user setup sheets with both pages opened out.

APPENDIX

Customer	
Device Name	
Mfg. No.	

● Range setting (individual channels): RNG

- Setup details

Display No.	Setup Item	Setup Description	Menu Level	Factory Setting
f	Recording mode	0 (OFF)/1 (display)/2 (display + recording)/3 (digital input-dependent)	1	2 (display + recording)
g	Range code	See Range Code Table (page 6-47).	1	05 (±5V)
h	Digital signal No.	0 to 62	1	0
i	Burnout	0 (OFF)/1 (UP)/2 (DOWN)	1	0 (OFF)
j	Measurement range lower limit	-19999 to measurement range upper limit -1	1	1.000
k	Measurement range upper limit	Measurement range lower limit + 1 to 29999	1	5.000
l	Engineering range decimal point	0 (xxxxx) to 4 (x.xxxx)	1	1 (xxxx.x)
m	Engineering range lower limit	-19999 to +29999	1	0.0
n	Engineering range upper limit	-19999 to +29999	1	100.0
o	PV filter	0 to 15	1	0
p	PV bias	-19999 to +29999	1	0.0
q	Engineering unit	6 characters	1	Blank
r	Tag	12 characters	1	CH1 to 24 (shift to right)
s	Calculation setup entry	0: Entry to calculation setup disabled 1: Entry to calculation setup enabled	2	0

● Calculation setup (individual channels): RNG

- Setup details

Display No.	Setup Item	Setup Description	Menu Level	Factory Setting	
t	Input calculation type	0: OFF (PV value) 1: A Channel - B channel 2: Fixed value - current channel 3: Current channel - fixed value 4: Integrating calculation 5: F value calculation 6: Relative humidity calculation	2	0	
u	Calculation parameter 1	Conditions	2		
		Input calculation type = 1		1 to number of channels	Current channel
		Input calculation type = 2		-19999 to +29999	0.0
		Input calculation type = 3		-19999 to +29999	0.0
		Input calculation type = 4		0: s 1: min 2: h	0
		Input calculation type = 5		0.0 to 500.0	121.1
	Input calculation type = 6	1 to number of channels	*		
v	Calculation parameter 2	Input calculation type = 1	2	Current channel	
		Input calculation type = 4		1 to 6	1
		Input calculation type = 5		1 to 6	1
		Input calculation type = 6		0: Large (2.5m/s or more) 1: Medium (0.5 to 2.5m/s) 2: Small (less than 0.5m/s)	0
w	Calculation parameter 3	0 to 10	2	0	
x	Segment table use	0: Use disabled 1: Use segment table 1 2: Use segment table 2 3: Use segment table 3	2	0	

Page	
Model No.	
Prepared by	
Date Prepared	

• User Setup Fields

Display No.	Setup Item	User Settings					
		Channel	Channel	Channel	Channel	Channel	Channel
1	Recording mode						
2	Range code						
3	Digital signal No.						
4	Burnout						
5	Measurement range lower limit						
6	Measurement range upper limit						
7	Engineering range decimal point						
8	Engineering range lower limit						
9	Engineering range upper limit						
A	PV filter						
b	PV bias						
c	Engineering unit						
d	Tag						
E	Calculation setup entry	—	—	—	—	—	—

• User Setup Fields

Display No.	Setup Item	User Settings					
		Channel	Channel	Channel	Channel	Channel	Channel
1	Input calculation type						
2	Calculation parameter 1						
3	Calculation parameter 2						
4	Calculation parameter 3						
5	Segment table use						

APPENDIX

Customer	
Device Name	
Mfg. No.	

● Scale Setup (individual channels): SCL

• Setup details

Display No.	Setup Item	Setup Description	Menu Level	Factory Setting
1	No.1 scale lower limit	-19999 to +29999 or 0.0 to 98.0 <sup>1</sup>	1	0.0
2	No.1 scale upper limit	-19999 to +29999	1	100.0
3	Scale switching method selection	0: OFF 1: Automatic 2: Internal contact input, external switch input or CPL communications	1	0
4	No.2 scale lower limit	-19999 to +29999 or 0.0 to 98.0 <sup>1</sup>	1	0.0
5	No.2 scale upper limit	-19999 to +29999	1	100.0
6	Auto-switching point	-19999 to +29999	1	0.0
7	Auto-switching differential	0 to 29999	1	0.0

● Event Setting (individual channels): EVNT

Display No.	Setup Item	Setup Description	Menu Level	Factory Setting
1	No.1 event setting value	-19999 to +29999	0	0
2	No.2 event setting value	-19999 to +29999	0	0
3	No.3 event setting value	-19999 to +29999	0	0
4	No.4 event setting value	-19999 to +29999	0	0
5	No.1 event type selection	- (OFF)/L (LOW)/H (HIGH)	0	- (OFF)
6	No.2 event type selection	- (OFF)/L (LOW)/H (HIGH)	0	- (OFF)
7	No.3 event type selection	- (OFF)/L (LOW)/H (HIGH)	0	- (OFF)
8	No.4 event type selection	- (OFF)/L (LOW)/H (HIGH)	0	- (OFF)
5	No.1 event output destination	0 to 36	0	0
6	No.2 event output destination	0 to 36	0	0
7	No.3 event output destination	0 to 36	0	0
8	No.4 event output destination	0 to 36	0	0
5	No.1 event recording ON/OFF	0 (OFF)/1 (ON)	0	1 (ON)
6	No.2 event recording ON/OFF	0 (OFF)/1 (ON)	0	1 (ON)
7	No.3 event recording ON/OFF	0 (OFF)/1 (ON)	0	1 (ON)
8	No.4 event recording ON/OFF	0 (OFF)/1 (ON)	0	1 (ON)
9	No.1 event differential	0 to 29999	1	0
A	No.2 event differential	0 to 29999	1	0
b	No.3 event differential	0 to 29999	1	0
c	No.4 event differential	0 to 29999	1	0

Page	
Model No.	
Prepared by	
Date Prepared	

• User Setup Fields

Display No.	Setup Item	User Settings					
		Channel	Channel	Channel	Channel	Channel	Channel
1	No.1 scale lower limit						
2	No.1 scale upper limit						
3	Scale switching method selection						
4	No.2 scale lower limit						
5	No.2 scale upper limit						
6	Auto-switching point						
7	Auto-switching differential						

• User Setup Fields

Display No.	Setup Item	User Settings					
		Channel	Channel	Channel	Channel	Channel	Channel
1	No.1 event setting value						
2	No.2 event setting value						
3	No.3 event setting value						
4	No.4 event setting value						
5	No.1 event type selection						
6	No.2 event type selection						
7	No.3 event type selection						
8	No.4 event type selection						
5	No.1 event output destination						
6	No.2 event output destination						
7	No.3 event output destination						
8	No.4 event output destination						
5	No.1 event recording ON/OFF						
6	No.2 event recording ON/OFF						
7	No.3 event recording ON/OFF						
8	No.4 event recording ON/OFF						
9	No.1 event differential						
A	No.2 event differential						
b	No.3 event differential						
c	No.4 event differential						



APPENDIX

Customer	
Device Name	
Mfg. No.	

● **System Setup (individual channels): SYS**

• Setup details

Display No.	Setup Item	Setup Description	Menu Level	Factory Setting
1	Configuration lock	0 (OFF)/1 (ON)	0	0 (OFF)
2	List printing start/stop	0: Stop list printing 1: Start specified list printing 2: Start range/scale settings printing 3: Start event and DI/DO settings printing 4: Start MSG, S.DMD, UF and communications settings printing 5: Start segment table settings printing 6: Start all list printing 7: Start communications list printing	0	0 (stop)
3	Menu level	0 to 2	0	0
4	Recording format	1: Trend 2: Trend + tabulation 3: Trend + schedule demand 4: Fixed interval tabulation (tabulation only) 5: Fixed time tabulation (tabulation only)	1	2
5	Recorder ID No.	0 to 99	1	0
6	Recording time ON/OFF	0 (OFF)/1 (ON)	1	1 (ON)
7	Scale recording ON/OFF	0 (OFF)/1 (ON)	1	1 (ON)
8	Recording color selection	1 (STD)/2 (DIN)	1	1 (STD)
9	Communications access rights	1 (read)/2 (read/write)	1	1 (read)
A	Device address	0 to 127 (setting to "0" inhibits communications)	1	0
b	Communications method	1: 4800 bps, 8bits, even parity, 1 stop bit 2: 4800 bps, 8bits, no parity, 2 stop bits 3: 9600 bps, 8bits, even parity, 1 stop bit 4: 9600 bps, 8bits, no parity, 2 stop bits	1	1
c	Extended menu entry	0: Migration disabled 1: Migration to extended setup mode 2: Migration to DI/DO-related setup mode 3: Migration to segment table setup mode	2	0

● **Chart Feed Speed Setup (individual channels): SPD**

• Setup details

Display No.	Setup Item	Setup Description	Menu Level	Factory Setting
1	No.1 chart feed speed	1 to 480mm/h	0	20
2	No.2 chart feed speed	1 to 480mm/h	1	20
3	Fixed date interval timer	1: 10min 2: 20min 3: 30min 4: 1h 5: 2h 6: 3h 7: 6h 8: 12h 9: 24h	1	1
4	Fixed time interval timer	00:05 to 23:59	1	00:30

Page	
Model No.	
Prepared by	
Date Prepared	

• User Setup Fields

Display No.	Setup Item	User Settings
1	Configuration lock	
2	List printing start/stop	
3	Menu level	
4	Recording format	
5	Recorder ID No.	
6	Recording time ON/OFF	
7	Scale recording ON/OFF	
8	Recording color selection	
9	Communications access rights	
A	Device address	
b	Communications method	
c	Extended menu entry	—

• User Setup Fields

Display No.	Setup Item	User Settings
1	No.1 chart feed speed	
2	No.2 chart feed speed	
3	Fixed date interval timer	
4	Fixed time interval timer	

**APPENDIX**

Customer	
Device Name	
Mfg. No.	

● **Schedule Demand (individual channels): SYS + 5 d.**

- Setup details

Display No.	Setup Item	Setup Description	Menu Level	Factory Setting
1	Time setup ON/OFF	0: Time setup disabled (schedule demand printing is not carried out) 1: No.1 time setup enabled 2: No.1 and 2 time setup enabled 3: No.1 to 3 time setup enabled 4: No.1 to 4 time setup enabled 5: No.1 to 5 time setup enabled 6: No.1 to 6 time setup enabled 7: No.1 to 7 time setup enabled 8: No.1 to 8 time setup enabled	2	0
2	No.1 time setup	00:00 to 23:59	2	00:00
3	No.2 time setup			
4	No.3 time setup			
5	No.4 time setup			
6	No.5 time setup			
7	No.6 time setup			
8	No.7 time setup			
9	No.8 time setup			

● **Message Setup (individual channels): SYS + n.5.**

- Setup details

Display No.	Setup Item	Setup Description	Menu Level	Factory Setting
1	No.1 message	12 characters	2	"MSG1"
2	No.2 message			"MSG2"
3	No.3 message			"MSG3"
4	No.4 message			"MSG4"
5	No.5 message			"MSG5"
6	No.6 message			"MSG6"
7	No.7 message			"MSG7"
8	No.8 message			"MSG8"

Page	
Model No.	
Prepared by	
Date Prepared	

• User Setup Fields

Display No.	Setup Item	User Settings
1	Time setup ON/OFF	
2	No.1 time setup	
3	No.2 time setup	
4	No.3 time setup	
5	No.4 time setup	
6	No.5 time setup	
7	No.6 time setup	
8	No.7 time setup	
9	No.8 time setup	

• User Setup Fields

Display No.	Setup Item	User Settings
1	No.1 message	
2	No.2 message	
3	No.3 message	
4	No.4 message	
5	No.5 message	
6	No.6 message	
7	No.7 message	
8	No.8 message	

APPENDIX

Customer	
Device Name	
Mfg. No.	

● **User Function 1, 2 Keys Setup: SYS + U 1/2.**

- Setup details

Channel No.	Display No.	Setup Item	Setup Description	Menu Level	Factory Setting																																												
U 1.	1	User function 1 key basic registration	0: OFF 1: Output to internal contact input No.1 2: Call up setup items	2	0																																												
	2	User function 1 assignment 1	0 to 32500 When UF1 key basic registration is set to 2: Sets a value obtained by adding the following cardinal number to the setup No. of the settings to be registered: "0" means that nothing is assigned: <table style="margin-left: 20px;"> <tr> <td>Setup Item</td> <td>Cardinal Number</td> </tr> <tr> <td>Event</td> <td>1nn00</td> </tr> <tr> <td>Chart feed speed</td> <td>1000</td> </tr> <tr> <td>Date/time</td> <td>1500</td> </tr> <tr> <td>System</td> <td>2000</td> </tr> <tr> <td>Range</td> <td>2nn00</td> </tr> <tr> <td colspan="2">(Calculation setup is range setup + 5000.)</td> </tr> <tr> <td>Scale</td> <td>3nn00</td> </tr> <tr> <td>Copy</td> <td>6500</td> </tr> <tr> <td>Schedule demand</td> <td>2500</td> </tr> <tr> <td>Message</td> <td>3000</td> </tr> <tr> <td>Extended</td> <td>3500</td> </tr> <tr> <td>External switch input</td> <td>4000</td> </tr> <tr> <td>Internal contact input</td> <td>4100</td> </tr> <tr> <td>Relay output</td> <td>4200</td> </tr> <tr> <td>Open collector output</td> <td>4300</td> </tr> <tr> <td>Segment 1 X-axis</td> <td>5000</td> </tr> <tr> <td>Segment 1 Y-axis</td> <td>5100</td> </tr> <tr> <td>Segment 2 X-axis</td> <td>5200</td> </tr> <tr> <td>Segment 2 Y-axis</td> <td>5300</td> </tr> <tr> <td>Segment 3 X-axis</td> <td>5400</td> </tr> <tr> <td>Segment 3 Y-axis</td> <td>5500</td> </tr> </table> Item "nn" indicates the channel No. If the number is an alphabet character (hex), use a value after converting to a decimal number.	Setup Item	Cardinal Number	Event	1nn00	Chart feed speed	1000	Date/time	1500	System	2000	Range	2nn00	(Calculation setup is range setup + 5000.)		Scale	3nn00	Copy	6500	Schedule demand	2500	Message	3000	Extended	3500	External switch input	4000	Internal contact input	4100	Relay output	4200	Open collector output	4300	Segment 1 X-axis	5000	Segment 1 Y-axis	5100	Segment 2 X-axis	5200	Segment 2 Y-axis	5300	Segment 3 X-axis	5400	Segment 3 Y-axis	5500	2	0
	Setup Item	Cardinal Number																																															
	Event	1nn00																																															
	Chart feed speed	1000																																															
	Date/time	1500																																															
	System	2000																																															
	Range	2nn00																																															
	(Calculation setup is range setup + 5000.)																																																
Scale	3nn00																																																
Copy	6500																																																
Schedule demand	2500																																																
Message	3000																																																
Extended	3500																																																
External switch input	4000																																																
Internal contact input	4100																																																
Relay output	4200																																																
Open collector output	4300																																																
Segment 1 X-axis	5000																																																
Segment 1 Y-axis	5100																																																
Segment 2 X-axis	5200																																																
Segment 2 Y-axis	5300																																																
Segment 3 X-axis	5400																																																
Segment 3 Y-axis	5500																																																
3	User function 1 assignment 2	0																																															
4	User function 1 assignment 3	0																																															
5	User function 1 assignment 4	0																																															
6	User function 1 assignment 5	0																																															
7	User function 1 assignment 6	0																																															
8	User function 1 assignment 7	0																																															
9	User function 1 assignment 8	0																																															
U 2.	1	User function 2 key basic registration	0: OFF 1: Output to internal contact input No.2 2: Call up setup items	2	0																																												
	2	User function 2 assignment 1	Same as user function 1	2	0																																												
	3	User function 2 assignment 2			0																																												
	4	User function 2 assignment 3			0																																												
	5	User function 2 assignment 4			0																																												
	6	User function 2 assignment 5			0																																												
	7	User function 2 assignment 6			0																																												
	8	User function 2 assignment 7			0																																												
	9	User function 2 assignment 8			0																																												

Page	
Model No.	
Prepared by	
Date Prepared	

• User Setup Fields

Display No.	Setup Item	User Settings
1	User function 1 key basic registration	
2	User function 1 assignment 1	
3	User function 1 assignment 2	
4	User function 1 assignment 3	
5	User function 1 assignment 4	
6	User function 1 assignment 5	
7	User function 1 assignment 6	
8	User function 1 assignment 7	
9	User function 1 assignment 8	

• User Setup Fields

Display No.	Setup Item	User Settings
1	User function 2 key basic registration	
2	User function 2 assignment 1	
3	User function 2 assignment 2	
4	User function 2 assignment 3	
5	User function 2 assignment 4	
6	User function 2 assignment 5	
7	User function 2 assignment 6	
8	User function 2 assignment 7	
9	User function 2 assignment 8	

APPENDIX

Customer	
Device Name	
Mfg. No.	

● **Extended Setup: SYS + ξ ζ.**

- Setup details

Display No.	Setup Item	Setup Description	Menu Level	Factory Setting
1	Initial printing ON/OFF	0: OFF 1: ON	2	1
2	Count function switching	0: Batch count 1: BIN code	2	0
3	Date type selection	0: JP (YY, MM, DD) 1: US (MM, DD, YY) 2: EU (DD, MM, YY)	2	0
4	Atmosphere	670 to 1330 (hPa)	2	1013
5	Thermal resistance	1.0 to 20.0	2	10.0
6	Reference contact compensation	0: Internally OFF 1: Internally ON	2	1

● **External Switch Input Setup: ST + ξ 5.**

- Setup details

Display No.	Setup Item	Setup Description	Menu Level	Factory Setting	
				External switch input	Internal contact input
1	No.1 external switch input	0: Function setup OFF 1: Recording ON/OFF (all channels unconditionally) 2: Print on demand 3: Print all lists 4: Print specified lists 5: Chart feed 6: Print communications list 7: Chart feed speed/scale selection 8: Clear batch counter 11: Clear integrating calculation 1 12: Clear integrating calculation 2 13: Clear integrating calculation 3 14: Clear integrating calculation 4 15: Clear integrating calculation 5 16: Clear integrating calculation 6 21: Print No.1 message 22: Print No.2 message 23: Print No.3 message 24: Print No.4 message 25: Print No.5 message 26: Print No.6 message 27: Print No.7 message 28: Print No.8 message 31: Recording ON/OFF (channels 1 to 3) 32: Recording ON/OFF (channels 4 to 6) 33: Recording ON/OFF (channels 7 to 9) 34: Recording ON/OFF (channels 10 to 12) 35: Recording ON/OFF (channels 13 to 18) 36: Recording ON/OFF (channels 19 to 24) 40: BIN code input 2 <sup>0</sup> (+1) 41: BIN code input 2 <sup>1</sup> (+2) 42: BIN code input 2 <sup>2</sup> (+4) 43: BIN code input 2 <sup>3</sup> (+8) 44: BIN code input 2 <sup>4</sup> (+16) 45: BIN code input 2 <sup>5</sup> (+32)	2	1	0
2	No.2 external switch input			2	0
3	No.3 external switch input			5	0
4	No.4 external switch input			21	0
5	No.5 external switch input			0	0
6	No.6 external switch input			0	0
7	No.7 external switch input			0	0
8	No.8 external switch input			0	0
9	No.9 external switch input			0	0
10	No.10 external switch input			0	0
11	No.11 external switch input			0	0
12	No.12 external switch input			0	0

Page	
Model No.	
Prepared by	
Date Prepared	

• User Setup Fields

Display No.	Setup Item	User Settings
1	Initial printing ON/OFF	
2	Count function switching	
3	Date type selection	
4	Atmosphere	
5	Thermal resistance	
6	Reference contact compensation	

• User Setup Fields

Display No.	Setup Item	User Settings
1	No.1 external switch input	
2	No.2 external switch input	
3	No.3 external switch input	
4	No.4 external switch input	
5	No.5 external switch input	
6	No.6 external switch input	
7	No.7 external switch input	
8	No.8 external switch input	
9	No.9 external switch input	
A	No.10 external switch input	
b	No.11 external switch input	
c	No.12 external switch input	



APPENDIX

Customer	
Device Name	
Mfg. No.	

● **Internal Contact Input Setup: ST + / 5.**

• Setup details

Display No.	Setup Item	Setup Description	Menu Level	Factory Setting	
				External switch input	Internal contact input
1	No.1 internal contact input	0: Function setup OFF 1: Recording ON/OFF (all channels unconditionally) 2: Print on demand 3: Print all lists 4: Print specified lists 5: Chart feed 6: Print communications list 7: Chart feed speed/scale selection 8: Clear batch counter 11: Clear integrating calculation 1 12: Clear integrating calculation 2 13: Clear integrating calculation 3 14: Clear integrating calculation 4 15: Clear integrating calculation 5 16: Clear integrating calculation 6 21: Print No.1 message 22: Print No.2 message 23: Print No.3 message 24: Print No.4 message 25: Print No.5 message 26: Print No.6 message 27: Print No.7 message 28: Print No.8 message 31: Recording ON/OFF (channels 1 to 3) 32: Recording ON/OFF (channels 4 to 6) 33: Recording ON/OFF (channels 7 to 9) 34: Recording ON/OFF (channels 10 to 12) 35: Recording ON/OFF (channels 13 to 18) 36: Recording ON/OFF (channels 19 to 24) 40: BIN code input 2 <sup>0</sup> (+1) 41: BIN code input 2 <sup>1</sup> (+2) 42: BIN code input 2 <sup>2</sup> (+4) 43: BIN code input 2 <sup>3</sup> (+8) 44: BIN code input 2 <sup>4</sup> (+16) 45: BIN code input 2 <sup>5</sup> (+32)	2	1	0
2	No.2 internal contact input			2	0
3	No.3 internal contact input			5	0
4	No.4 internal contact input			21	0
5	No.5 internal contact input			0	0
6	No.6 internal contact input			0	0
7	No.7 internal contact input			0	0
8	No.8 internal contact input			0	0
9	No.9 internal contact input			0	0
A	No.10 internal contact input			0	0
B	No.11 internal contact input			0	0
C	No.12 internal contact input			0	0

● **Relay Output Setup: SYS + r 0.**

• Setup details

Display No.	Setup Item	Setup Description	Menu Level	Factory Setting
1	No.1 relay output	0: OR action/excitation/non-hold 1: OR action/excitation/hold 2: OR action/non-excitation/non-hold 3: OR action/non-excitation/hold 4: AND action/excitation/non-hold 5: AND action/excitation/hold 6: AND action/non-excitation/non-hold 7: AND action/non-excitation/hold 8: OR action/excitation/non-hold/event re-output 9: OR action/non-excitation/non-hold/event re-output	2	0
2	No.2 relay output			
3	No.3 relay output			
4	No.4 relay output			
5	No.5 relay output			
6	No.6 relay output			
7	No.7 relay output			
8	No.8 relay output			
9	No.9 relay output			
A	No.10 relay output			
B	No.11 relay output			
C	No.12 relay output			

Page	
Model No.	
Prepared by	
Date Prepared	

• User Setup Fields

Display No.	Setup Item	User Settings
1	No.1 internal contact input	
2	No.2 internal contact input	
3	No.3 internal contact input	
4	No.4 internal contact input	
5	No.5 internal contact input	
6	No.6 internal contact input	
7	No.7 internal contact input	
8	No.8 internal contact input	
9	No.9 internal contact input	
A	No.10 internal contact input	
b	No.11 internal contact input	
c	No.12 internal contact input	

• User Setup Fields

Display No.	Setup Item	User Settings
1	No.1 relay output	
2	No.2 relay output	
3	No.3 relay output	
4	No.4 relay output	
5	No.5 relay output	
6	No.6 relay output	
7	No.7 relay output	
8	No.8 relay output	
9	No.9 relay output	
A	No.10 relay output	
b	No.11 relay output	
c	No.12 relay output	

**APPENDIX**

Customer	
Device Name	
Mfg. No.	

● **Open Collector Output Setup: SYS + d o.**

- Setup details

Display No.	Setup Item	Setup Description	Menu Level	Factory Setting
1	No.1 open collector output	0: OR action/excitation/non-hold	2	0
2	No.2 open collector output	1: OR action/excitation/hold		
3	No.3 open collector output	2: OR action/non-excitation/non-hold		
4	No.4 open collector output	3: OR action/non-excitation/hold		
5	No.5 open collector output	4: AND action/excitation/non-hold		
6	No.6 open collector output	5: AND action/excitation/hold		
7	No.7 open collector output	6: AND action/non-excitation/non-hold		
8	No.8 open collector output	7: AND action/non-excitation/hold		
9	No.9 open collector output	8: OR action/excitation/non-hold/event re-output		
10	No.10 open collector output	9: OR action/non-excitation/non-hold/event re-output		
11	No.11 open collector output			
12	No.12 open collector output			

Page	
Model No.	
Prepared by	
Date Prepared	

• User Setup Fields

Display No.	Setup Item	User Settings
1	No.1 open collector output	
2	No.2 open collector output	
3	No.3 open collector output	
4	No.4 open collector output	
5	No.5 open collector output	
6	No.6 open collector output	
7	No.7 open collector output	
8	No.8 open collector output	
9	No.9 open collector output	
10	No.10 open collector output	
11	No.11 open collector output	
12	No.12 open collector output	

APPENDIX

Customer	
Device Name	
Mfg. No.	

● **Segment Table 1 Setup: SYS + ㄱ ㄱ.**

• Setup details

Channel No.	Display No.	Setup Item	Setup Description	Menu Level	Factory Setting
ㄱ ㄱ.	1	Segment table 1 X-axis point 01	-10.00 to +110.00%	2	0.00
	2	Segment table 1 X-axis point 02			100.00
	3	Segment table 1 X-axis point 03			100.00
	4	Segment table 1 X-axis point 04			100.00
	5	Segment table 1 X-axis point 05			100.00
	6	Segment table 1 X-axis point 06			100.00
	7	Segment table 1 X-axis point 07			100.00
	8	Segment table 1 X-axis point 08			100.00
	9	Segment table 1 X-axis point 09			100.00
	ㄱ	Segment table 1 X-axis point 10			100.00
	ㄴ	Segment table 1 X-axis point 11			100.00
	ㄷ	Segment table 1 X-axis point 12			100.00
	ㄹ	Segment table 1 X-axis point 13			100.00
	ㅁ	Segment table 1 X-axis point 14			100.00
	ㅂ	Segment table 1 X-axis point 15			100.00

● **Segment Table 1 Setup: SYS + ㄱ ㄴ.**

• Setup details

Channel No.	Display No.	Setup Item	Setup Description	Menu Level	Factory Setting
ㄱ ㄴ.	1	Segment table 1 Y-axis point 01	-10.00 to +110.00%	2	0.00
	2	Segment table 1 Y-axis point 02			100.00
	3	Segment table 1 Y-axis point 03			100.00
	4	Segment table 1 Y-axis point 04			100.00
	5	Segment table 1 Y-axis point 05			100.00
	6	Segment table 1 Y-axis point 06			100.00
	7	Segment table 1 Y-axis point 07			100.00
	8	Segment table 1 Y-axis point 08			100.00
	9	Segment table 1 Y-axis point 09			100.00
	ㄱ	Segment table 1 Y-axis point 10			100.00
	ㄴ	Segment table 1 Y-axis point 11			100.00
	ㄷ	Segment table 1 Y-axis point 12			100.00
	ㄹ	Segment table 1 Y-axis point 13			100.00
	ㅁ	Segment table 1 Y-axis point 14			100.00
	ㅂ	Segment table 1 Y-axis point 15			100.00

Page	
Model No.	
Prepared by	
Date Prepared	

• User Setup Fields

Display No.	Setup Item	User Settings
1	Segment table 1 X-axis point 01	
2	Segment table 1 X-axis point 02	
3	Segment table 1 X-axis point 03	
4	Segment table 1 X-axis point 04	
5	Segment table 1 X-axis point 05	
6	Segment table 1 X-axis point 06	
7	Segment table 1 X-axis point 07	
8	Segment table 1 X-axis point 08	
9	Segment table 1 X-axis point 09	
A	Segment table 1 X-axis point 10	
b	Segment table 1 X-axis point 11	
c	Segment table 1 X-axis point 12	
d	Segment table 1 X-axis point 13	
E	Segment table 1 X-axis point 14	
F	Segment table 1 X-axis point 15	

• User Setup Fields

Display No.	Setup Item	User Settings
1	Segment table 1 Y-axis point 01	
2	Segment table 1 Y-axis point 02	
3	Segment table 1 Y-axis point 03	
4	Segment table 1 Y-axis point 04	
5	Segment table 1 Y-axis point 05	
6	Segment table 1 Y-axis point 06	
7	Segment table 1 Y-axis point 07	
8	Segment table 1 Y-axis point 08	
9	Segment table 1 Y-axis point 09	
A	Segment table 1 Y-axis point 10	
b	Segment table 1 Y-axis point 11	
c	Segment table 1 Y-axis point 12	
d	Segment table 1 Y-axis point 13	
E	Segment table 1 Y-axis point 14	
F	Segment table 1 Y-axis point 15	

APPENDIX

Customer	
Device Name	
Mfg. No.	

● **Segment Table 2 Setup: SYS + ㄱ ㄴ.**

• Setup details

Channel No.	Display No.	Setup Item	Setup Description	Menu Level	Factory Setting
ㄱ ㄴ.	1	Segment table 2 X-axis point 01	-10.00 to +110.00%	2	0.00
	2	Segment table 2 X-axis point 02			100.00
	3	Segment table 2 X-axis point 03			100.00
	4	Segment table 2 X-axis point 04			100.00
	5	Segment table 2 X-axis point 05			100.00
	6	Segment table 2 X-axis point 06			100.00
	7	Segment table 2 X-axis point 07			100.00
	8	Segment table 2 X-axis point 08			100.00
	9	Segment table 2 X-axis point 09			100.00
	A	Segment table 2 X-axis point 10			100.00
	b	Segment table 2 X-axis point 11			100.00
	c	Segment table 2 X-axis point 12			100.00
	d	Segment table 2 X-axis point 13			100.00
	E	Segment table 2 X-axis point 14			100.00
	F	Segment table 2 X-axis point 15			100.00

● **Segment Table 2 Setup: SYS + ㄱ ㄷ.**

• Setup details

Channel No.	Display No.	Setup Item	Setup Description	Menu Level	Factory Setting
ㄱ ㄷ.	1	Segment table 2 Y-axis point 01	-10.00 to +110.00%	2	0.00
	2	Segment table 2 Y-axis point 02			100.00
	3	Segment table 2 Y-axis point 03			100.00
	4	Segment table 2 Y-axis point 04			100.00
	5	Segment table 2 Y-axis point 05			100.00
	6	Segment table 2 Y-axis point 06			100.00
	7	Segment table 2 Y-axis point 07			100.00
	8	Segment table 2 Y-axis point 08			100.00
	9	Segment table 2 Y-axis point 09			100.00
	A	Segment table 2 Y-axis point 10			100.00
	b	Segment table 2 Y-axis point 11			100.00
	c	Segment table 2 Y-axis point 12			100.00
	d	Segment table 2 Y-axis point 13			100.00
	E	Segment table 2 Y-axis point 14			100.00
	F	Segment table 2 Y-axis point 15			100.00

Page	
Model No.	
Prepared by	
Date Prepared	

• User Setup Fields

Display No.	Setup Item	User Settings
1	Segment table 2 X-axis point 01	
2	Segment table 2 X-axis point 02	
3	Segment table 2 X-axis point 03	
4	Segment table 2 X-axis point 04	
5	Segment table 2 X-axis point 05	
6	Segment table 2 X-axis point 06	
7	Segment table 2 X-axis point 07	
8	Segment table 2 X-axis point 08	
9	Segment table 2 X-axis point 09	
A	Segment table 2 X-axis point 10	
b	Segment table 2 X-axis point 11	
c	Segment table 2 X-axis point 12	
d	Segment table 2 X-axis point 13	
E	Segment table 2 X-axis point 14	
F	Segment table 2 X-axis point 15	

• User Setup Fields

Display No.	Setup Item	User Settings
1	Segment table 2 Y-axis point 01	
2	Segment table 2 Y-axis point 02	
3	Segment table 2 Y-axis point 03	
4	Segment table 2 Y-axis point 04	
5	Segment table 2 Y-axis point 05	
6	Segment table 2 Y-axis point 06	
7	Segment table 2 Y-axis point 07	
8	Segment table 2 Y-axis point 08	
9	Segment table 2 Y-axis point 09	
A	Segment table 2 Y-axis point 10	
b	Segment table 2 Y-axis point 11	
c	Segment table 2 Y-axis point 12	
d	Segment table 2 Y-axis point 13	
E	Segment table 2 Y-axis point 14	
F	Segment table 2 Y-axis point 15	



APPENDIX

Customer	
Device Name	
Mfg. No.	

● Segment Table 3 Setup: SYS + ㄨ ㄨ.

• Setup details

Channel No.	Display No.	Setup Item	Setup Description	Menu Level	Factory Setting
ㄨ ㄨ.	1	Segment table 3 X-axis point 01	-10.00 to +110.00%	2	0.00
	2	Segment table 3 X-axis point 02			100.00
	3	Segment table 3 X-axis point 03			100.00
	4	Segment table 3 X-axis point 04			100.00
	5	Segment table 3 X-axis point 05			100.00
	6	Segment table 3 X-axis point 06			100.00
	7	Segment table 3 X-axis point 07			100.00
	8	Segment table 3 X-axis point 08			100.00
	9	Segment table 3 X-axis point 09			100.00
	A	Segment table 3 X-axis point 10			100.00
	b	Segment table 3 X-axis point 11			100.00
	c	Segment table 3 X-axis point 12			100.00
	d	Segment table 3 X-axis point 13			100.00
	E	Segment table 3 X-axis point 14			100.00
	F	Segment table 3 X-axis point 15			100.00

● Segment Table 3 Setup: SYS + ㄨ F.

• Setup details

Channel No.	Display No.	Setup Item	Setup Description	Menu Level	Factory Setting
ㄨ F.	1	Segment table 3 Y-axis point 01	-10.00 to +110.00%	2	0.00
	2	Segment table 3 Y-axis point 02			100.00
	3	Segment table 3 Y-axis point 03			100.00
	4	Segment table 3 Y-axis point 04			100.00
	5	Segment table 3 Y-axis point 05			100.00
	6	Segment table 3 Y-axis point 06			100.00
	7	Segment table 3 Y-axis point 07			100.00
	8	Segment table 3 Y-axis point 08			100.00
	9	Segment table 3 Y-axis point 09			100.00
	A	Segment table 3 Y-axis point 10			100.00
	b	Segment table 3 Y-axis point 11			100.00
	c	Segment table 3 Y-axis point 12			100.00
	d	Segment table 3 Y-axis point 13			100.00
	E	Segment table 3 Y-axis point 14			100.00
	F	Segment table 3 Y-axis point 15			100.00

Page	
Model No.	
Prepared by	
Date Prepared	

• User Setup Fields

Display No.	Setup Item	User Settings
1	Segment table 3 X-axis point 01	
2	Segment table 3 X-axis point 02	
3	Segment table 3 X-axis point 03	
4	Segment table 3 X-axis point 04	
5	Segment table 3 X-axis point 05	
6	Segment table 3 X-axis point 06	
7	Segment table 3 X-axis point 07	
8	Segment table 3 X-axis point 08	
9	Segment table 3 X-axis point 09	
A	Segment table 3 X-axis point 10	
b	Segment table 3 X-axis point 11	
c	Segment table 3 X-axis point 12	
d	Segment table 3 X-axis point 13	
E	Segment table 3 X-axis point 14	
F	Segment table 3 X-axis point 15	

• User Setup Fields1

Display No.	Setup Item	User Settings
1	Segment table 3 Y-axis point 01	
2	Segment table 3 Y-axis point 02	
3	Segment table 3 Y-axis point 03	
4	Segment table 3 Y-axis point 04	
5	Segment table 3 Y-axis point 05	
6	Segment table 3 Y-axis point 06	
7	Segment table 3 Y-axis point 07	
8	Segment table 3 Y-axis point 08	
9	Segment table 3 Y-axis point 09	
A	Segment table 3 Y-axis point 10	
b	Segment table 3 Y-axis point 11	
c	Segment table 3 Y-axis point 12	
d	Segment table 3 Y-axis point 13	
E	Segment table 3 Y-axis point 14	
F	Segment table 3 Y-axis point 15	

# Revision History

Printed date	Manual Number	Edition	Revised pages	Description
Apr. 1998	CP-SP-1027E	1st Edition		
Dec. 1999		2nd Edition		Company name changed Overall revision
Apr. 2000		3rd Edition	iv v  1-3 6-11	Standard folding chart to folding chart changed Two manuals to three manuals changed, Smart Loader Package SLP-F20 for Dot Printing Model Smart Recorder SRF200 Manual No.CP-UM-5067E added Folding chart (Recycled paper) 100-sections added Note added
Oct. 2000		4th Edition	v 3-12 3-13  6-19  8-3 8-4, 8-5	Description of CP-UM-5067E changed Deleted description of CMA50A105 Connection examples changed, reference cable model No., changed, and conversion connector added Changed record mode "3" digital signal No. to input-dependent Description of AL15 added Countermeasure method items at trouble occurrence added
July 2001		5th Edition	1-3	Fonts change Model.No. of Folding chart (Recycled paper) changed
Aug. 2002		6th Edition	i 9-1	Description of About Icons changed Conformed standard added
June 2003		7th Edition	3-13	RESTRICTIONS ON USE changed Adapter model No.:81408811-001 deleted
Dec. 2003		8th Edition	i  ii, iii 1-3  3-12 9-3	SAFETY REQUIREMENT changed to page i from page iii Old pages i and ii Model No. 81407861 except for item 001, and 81408857 changed to 81409978 Handling Precautions added Recording accuracy of PV axis, $\pm 0.5\%$ changed to $\pm 0.3\%$ , and page 9-2 corrected to page 9-7
May 2004		9th Edition	3-4	M4 screw was added to Recommended Crimped Terminal
Sep. 2004		10th Edition	i  1-4 3-3 9-1 9-2	Installation category: CategoryII(IEC664-1, EN61010-1)→Over-voltage category: Category II (IEC60364-4-443,IEC60664-1) changed. Common mode voltage changed. Model No. 81446645-007 added. CAUTION 1 item added. Altitude added. Warm up time added. Input type changed.
Mar. 2005		11th Edition	1-3 9-2	●Consumables changed. Input type Thermocouple "N" deleted.
Aug. 2005		12th Edition	iii 4-1  4-4	Caution on chart and ink ribbon cassette was added. Handling Precautions deleted, ■Loading the Chart changed. ■Loading the Ink Ribbon Cassette was transferred from page 4-5. Description was added in the figure of procedure 2.

Printed date	Manual Number	Edition	Revised pages	Description
Aug. 2005	CP-SP-1027E	12th Edition	4-5 to 4-11 4-12 4-13 6-37	Old 4-6 to 4-12 page. ■ Replacing the Chart added. ■ Replacing the Ink Ribbon Cassette added. ● Internal Contact Input Setup "1" (Migration to extended setup mode)→ "2" (Migration to DI/DO-related setup mode) changed.
July 2006		13th Edition	7-9	In PV axis (horizontal) direction: Display accuracy + (±0.5% of recording F.S.)→ Display accuracy + (±0.3% of recording F.S.) changed.
Nov. 2006		14th Edition	i, 9-1  7-7  8-4	APPLICABLE STANDARDS: EN50081-2, EN50082-2 to EN61326 changed. Recording fluctuation: (0.5%F.S.) to (0.3%F.S.) changed. Remedy of "The chart has come loose from the sprockets": description added.
Aug. 2007		15th Edition	ii iii  iv  1-4  2-1  2-3  3-1  4-7 5-9  7-6	Description Examples changed. Description of 1st item and 8th item in CAUTION changed. Description of ■ Checking the Model No. changed. ● Optional parts; Model No. of Cross cable for RS-232C interface corrected. ■ Overall Schematic and Names of Parts; Power switch mentioned. ● Operation display: Data display; description changed. ■ Siting Conditions; description changed. Title changed. Title changed. 2nd item in Handling Precautions deleted. Note added. Section 7-4 deleted.
July 2008		16th Edition	6-30	"Setup example" added.





**azbil**

---

**Yamatake Corporation**  
**Advanced Automation Company**

1-12-2 Kawana, Fujisawa  
Kanagawa 251-8522 Japan

URL: <http://www.azbil.com>

*Specifications are subject to change without notice. (08)*

1st Edition: Issued in Aug. 1998 (W)  
16th Edition: Issued in July 2008 (W)