



Electric Motors High Efficiency



IE3

PREMIUM EFFICIENCY





INTRODUCTION

The conservative and responsible use of energy to save resources, to reduce the amount of CO₂ emissions and to decrease energy costs is the order of the day. The electrical drive system plays a key role in this process. Electrical drives form the link between the electrical energy supply and the majority of mechanical processes, which require a large amount of energy. Machines driven by electrical motors consume 2/3 of all the electrical energy used in industry. If the old systems in German industry, commerce and public facilities, which have been running for decades, were all replaced by modern drive systems, this would result in annual energy savings of 38 billion kilowatt hours. Calculated for all of Europe, this figure would be 135 billion kilowatt hours.

By using electronic speed control and Energy efficient motors, Europe's CO₂ emissions could be reduced by 69 million tonnes.

This brochure describes the new standardised international efficiency classes for standard three-phase motors, the new measuring methods and the requirements stipulated by the European Regulation 640/2009 of the European Commission for energy efficiency in motors and drive systems.

This brochure also offers an overview of some of the world-wide existing national legislation and addresses subjects like material composition and life cycle cost.

The catalogue is written for users, original equipment manufacturers (OEM), machine manufacturers and motor and drive system manufacturers.

Efficiency Classes of Motors and Measuring Methods

The "efficiency" describes how efficiently an electric motor transforms electrical energy into mechanical energy. Previously in Europe, low voltage three-phase motors have been graded and marketed in three efficiency classes – EFF3, EFF2 and EFF1 – based on a voluntary agreement between motor manufacturers and the European Commission.

This classification system is well proven and has now been adapted in many countries around the world. Unfortunately, other countries have also developed their own national systems, which are very different from the European system. That was the reason for the German motor manufacturers in ZVEI, with the support of their European neighbours, to develop an energy efficiency standard for the International Electrotechnical Commission (IEC).

The objective was to have a common international standard that replaces all the different national systems.

This project was successful and the objective has been met.

The new international standard, IEC 60034-30:2008, defines efficiency classes IE1, IE2 and IE3 for three-phase motors.

This ensures a common international basis for the design and classification of motors as well as for national legislative activities. At the same time, the IEC developed improved methods for determining the efficiency of these motors.

The international standards IEC 60034-30:2008 (classification) and IEC 60034-2-1:2007 (measuring methods) have been adopted as European standards without any changes as EN 60034-30:2009 and EN 60034-2-1:2007.

For the sake of simplicity, the following sections will refer to the IEC standards only.

Previous efficiency classes of motors in Europe

In 1998, as part of the voluntary agreement between the European sector committee of Manufacturers of Electrical Machines and Power Electronics (CEMEP) and the European Commission, three efficiency classes were defined for the power range of 1.1 kW to 90 kW:

- EFF3 = Motors with a low efficiency level
- EFF2 = Motors with an improved efficiency level
- EFF1 = Motors with a high efficiency level

New international standard for efficiency classes of motors (IE-code)

This voluntary agreement has since expired. However, the efficiency classes remain a registered European trademark. Use of the efficiency classes is based on a contractual licensing agreement between the participants in the voluntary agreement (motor manufacturers) and the license holder (CEMEP / Gimelec). This licensing agreement expires on 10 February 2010, but can be extended to 15 June 2011 upon request.

Standard IEC 60034-30:2008 defines the efficiency classes for low voltage three-phase motors with a power range from 0.75 kW to 375 kW. "IE" stands for "International Efficiency" and is combined with a number:

IE1 = Standard efficiency

IE2 = High efficiency

IE3 = Premium efficiency

New IEC measuring methods

The new measuring methods in accordance with IEC 60034-2-1:2007 (standard methods for determining losses and efficiency from tests) apply for all motors described by IEC 60034-1. These methods help to generate more exact data regarding stray load loss. The new standard replaces the previous European standard EN 60034-2:1996, which expired on 1 November 2010. Motors that are marked according to the new efficiency class system (IE-code) are required to be measured using the new measurement methods.

Comparison of old and new efficiency classes

The new international efficiency class system (IE-code) has an open numbering system. Compared to the old EFF efficiency classes, it is now easier to add future developments. In addition, there is a new class – IE3 – which did not exist in the old European EFF classification system.

The scope has also been extended significantly; the new IE-code applies to a larger power range as well as for the 60 Hz classes e.g. in the USA.

The main difference between the efficiency classes (EFF and IE) lies in the method used to determine them. In a direct comparison at the same motor, it is expected that the efficiency determined according to the new measuring method will be lower. For example, an 11 kW, 4-pole EFF1 motor with 91.0% efficiency is physically identical with a IE2 motor with 89.8% efficiency.

Scope of new IEC efficiency class system (IE-code)

The efficiency class system specified under IEC 60034-30 is valid for low voltage three-phase cage induction motors with the following specifications:

- Rated voltage up to 1,000 V
- Rated output between 0.75 kW and 375 kW
- Either 2, 4 or 6 poles
- Rated on the basis of continuous duty (S1) or intermittent periodic duty (S3) with cyclic duration factor of 80% or higher;
- Capable of operating direct on-line
- Rated for operating conditions in accordance with IEC 60034-1 (temperature, installation altitude, etc.)

Motors with flanges, feet and/or shafts with mechanical dimensions different from IEC 60072-1 are covered by this standard.

Geared motors and brake motors are covered by this standard, although special shafts and flanges may be used in such motors.

Some motors covered by this standard may be equipped with auxiliary devices. However, as long as these auxiliary devices are not an integral part of the motor construction, the determination of efficiency in all possible combinations is not practical. Determinations for efficiency of such modified standard motors shall be performed on basic motors without auxiliary devices installed. The following are exceptions to the classification system:

- Motors for short-time duty (S2) or switching operation (S3 < 80% to S10);
- Motors that were solely designed for converter operation (VSD) in accordance with IEC 60034-25 as well as
- Motors that have a highly specialized design customized for one particular application in such a way that it is not possible to measure the motor on its own (for example pump motors with wet rotors).

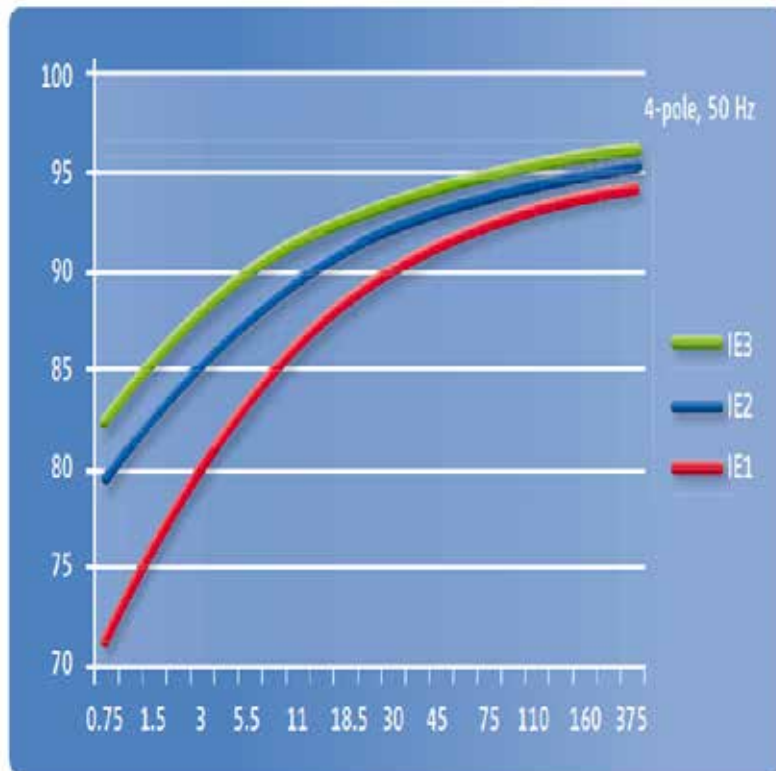

IE3 ALUMINIUM HOUSING - TECHNICAL DATA

TYPE	Power KW	RPM r/min	Voltage		Amp	Amp	Efficiency 100%	Efficiency 75%	Efficiency 50%	Power Factor cosφ 100 %	Locked Current Is/In	Locked Torque Ts/Tn	Locked Torque Tm/Tn	Moment of inertia Kgm2	Weight Kg.
			230	400											
FA3-80 1-2	0,75	2820	230	400	2,82	1,63	80,7	81,0	79,7	0,831	6,0	2,3	2,3	0,001	9,5
FA3-80 2-2	1,1	2820	230	400	4,00	2,30	82,7	82,9	81,5	0,836	7,5	2,3	2,3	0,002	11
FA3-90S-2	1,5	2840	230	400	5,23	3,02	84,2	85,0	84,0	0,857	7,5	2,4	2,4	0,002	15
FA3-90L-2	2,2	2840	230	400	7,44	4,30	85,9	86,5	86,0	0,865	7,5	2,4	2,4	0,003	18
FA3-100L-2	3	2850	230	400	9,90	5,72	87,1	87,3	86,2	0,873	8,0	2,4	2,4	0,005	25
FA3-112M-2	4	2870	400	690	7,48	4,32	88,1	88,4	88,0	0,88	8,5	2,4	2,4	0,008	28,5
FA3-132S1-2	5,5	2900	400	690	10,00	5,80	89,2	89,6	89,1	0,89	7,5	2,2	2,4	0,014	41
FA3-132S2-2	7,5	2900	400	690	13,50	7,80	90,1	90,5	90,0	0,892	7,5	2,2	2,4	0,017	46,5

TYPE	Power KW	RPM r/min	Voltage		Amp	Amp	Efficiency 100%	Efficiency 75%	Efficiency 50%	Power Factor cosφ	Locked Current Is/In	Locked Torque Ts/Tn	Locked Torque Tm/Tn	Moment of inertia Kgm2	Weight Kg.
			230	400											
FA3-80 2-4	0,75	1400	230	400	2,97	1,72	82,5	82,7	81,0	0,77	7,00	2,4	2,4	0,003	12
FA3-90S-4	1,1	1420	230	400	4,25	2,45	84,1	84,3	82,6	0,775	7,50	2,4	2,4	0,004	16
FA3-90L-4	1,5	1420	230	400	5,68	3,28	85,3	85,4	83,8	0,778	8,00	2,4	2,4	0,054	20
FA3-100L1-4	2,2	1440	230	400	8,00	4,62	86,7	86,8	84,3	0,798	8,00	2,4	2,4	0,010	26
FA3-100L2-4	3	1440	230	400	10,80	6,20	87,7	87,8	86,0	0,801	8,00	2,4	2,4	0,013	30
FA3-112M-4	4	1450	400	690	7,97	4,60	88,6	88,8	88,3	0,821	7,50	2,4	2,4	0,020	38
FA3-132S-4	5,5	1450	400	690	10,80	6,24	89,6	89,7	89,0	0,825	7,50	2,3	2,4	0,035	46
FA3-132M-4	7,5	1450	400	690	14,40	8,32	90,4	90,6	90,1	0,834	7,50	2,3	2,4	0,047	54

TYPE	Power KW	RPM r/min	Voltage		Amp	Amp	Efficiency 100%	Efficiency 75%	Efficiency 50%	Power Factor cosφ	Locked Current Is/In	Locked Torque Ts/Tn	Locked Torque Tm/Tn	Moment of inertia Kgm2	Weight Kg.
			230	400											
FA3-90S-6	0,75	910	230	400	3,42	1,97	78,9	79,4	77,5	0,7	4,00	2,0	2,3	0,005	15
FA3-90L-6	1,1	910	230	400	4,80	2,78	81,0	81,3	80,2	0,71	4,00	2,0	2,3	0,008	20
FA3-100L-6	1,5	930	230	400	6,35	3,66	82,5	82,6	81,3	0,72	5,00	2,0	2,3	0,013	25
FA3-112M-6	2,2	940	230	400	8,98	5,20	84,3	85,0	83,2	0,73	5,00	2,0	2,3	0,020	30
FA3-132S-6	3	960	230	400	11,90	6,87	85,6	85,8	84,5	0,74	6,50	2,2	2,3	0,037	38,5
FA3-132M1-6	4	960	400	690	9,00	5,20	86,8	86,9	85,3	0,745	7,00	2,2	2,3	0,050	47,5
FA3-132M2-6	5,5	960	400	690	12,10	7,00	88,0	88,2	86,9	0,75	7,00	2,2	2,3	0,065	58

IMB3 - IE3 - ALUMINIUM

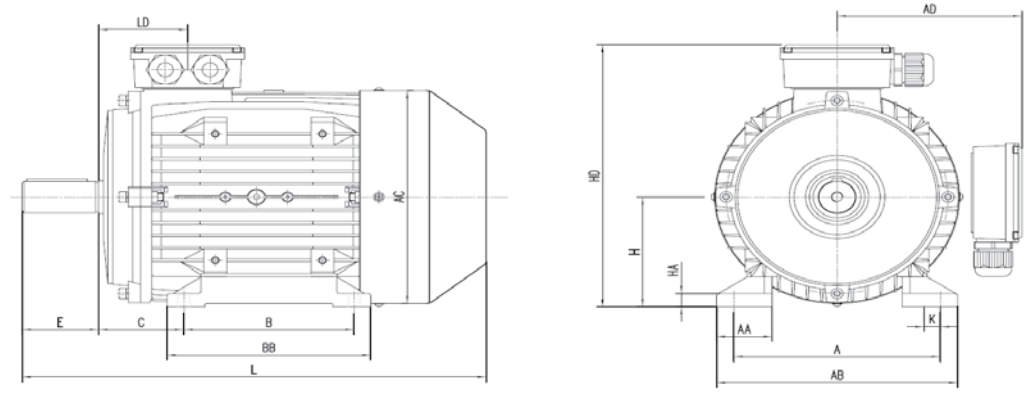

Frame Size	Pole	Dimensions					Dimensions								
		A	B	C	H	K	AA	AB	AC	AD	BB	HA	HD on top	LD	L
80	2-6	125	100	50	80° _{-0,5}	10	35	155	157	125	125	12	205	65	295
90S	2-6	140	100	56	90° _{-0,5}	10	37	180	177	138	155	14	228	66	355
90L	2-6	140	125	56	90° _{-0,5}	10	37	180	177	138	155	14	228	66	385
100L	2-6	160	140	63	100° _{-0,5}	12	45	200	205	150	180	14	250	85	440
112M	2-6	190	140	70	112° _{-0,5}	12	55	225	220	172	180	14	284	88	405
132S	2-8	216	140	89	132° _{-0,5}	12	58	255	256	192	176	14	324	94	455
132M	2-8	216	178	89	132° _{-0,5}	12	58	255	256	192	215	14	324	94	490

IMB5 - IE3 - ALUMINIUM

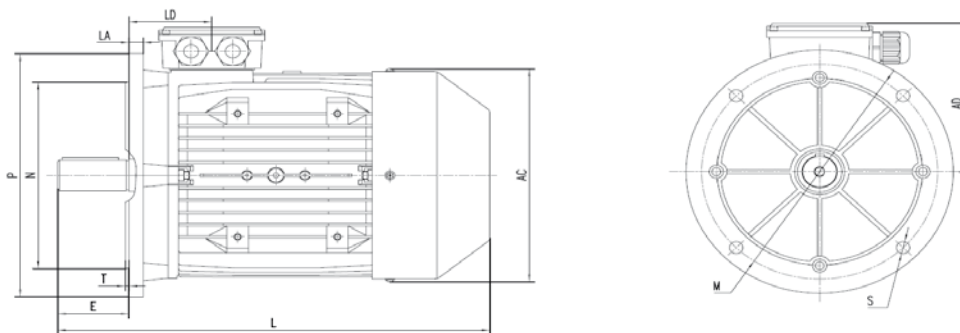

Frame Size	Pole	Dimensions				Dimensions					
		M	N	P	S	T	AC	AD	LA	LD	L
80	2-8	165	130	200	4-Φ12	4	157	125	12	65	295
90S	2-8	165	130	200	4-Φ12	4	177	138	12	66	355
90L	2-8	165	130	200	4-Φ12	4	177	138	12	66	385
100L	2-8	215	180	250	4-Φ15	4	205	150	14	85	440
112M	2-8	215	180	250	4-Φ15	4	220	172	14	88	405
132S	2-8	265	230	300	4-Φ15	4	256	192	15	94	455
132M	2-8	265	230	300	4-Φ15	4	256	192	15	94	490

IMB35 - IE3 - ALUMINIUM

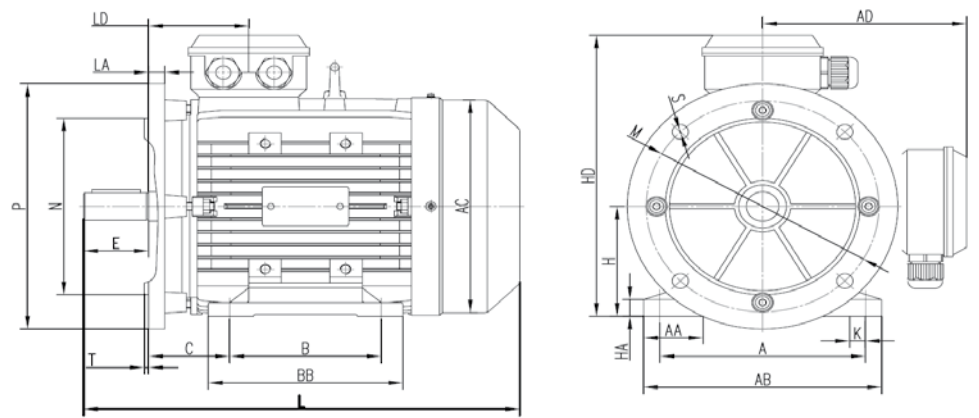

Frame Size	Pole	Dimensions											Dimensions									
		A	B	C	H	K	M	N	P	S	T	AA	AB	AC	AD	BB	HA	HD		LA	LD	L
																			Top	L&R		
80	2-6	125	100	50	80° _{-0,5}	10	165	130	200	4-Φ12	4	35	155	157	125	125	12	205	125	12	65	295
90S	2-6	140	100	56	90° _{-0,5}	10	165	130	200	4-Φ12	4	37	180	177	138	155	14	228	138	12	66	355
90L	2-6	140	125	56	90° _{-0,5}	10	165	130	200	4-Φ12	4	37	180	177	138	155	14	228	138	12	66	385
100L	2-6	160	140	63	100° _{-0,5}	12	215	180	250	4-Φ15	4	45	200	205	150	180	14	250	150	14	85	440
112M	2-6	190	140	70	112° _{-0,5}	12	215	180	250	4-Φ15	4	55	225	220	172	180	14	284	172	14	88	405
132S	2-6	216	140	89	132° _{-0,5}	12	265	230	300	4-Φ15	4	58	255	256	192	176	14	324	192	15	94	455
132M	2-6	216	178	89	132° _{-0,5}	12	265	230	300	4-Φ15	4	58	255	256	192	215	14	324	192	15	94	490

IMB14 - IE3 - ALUMINIUM

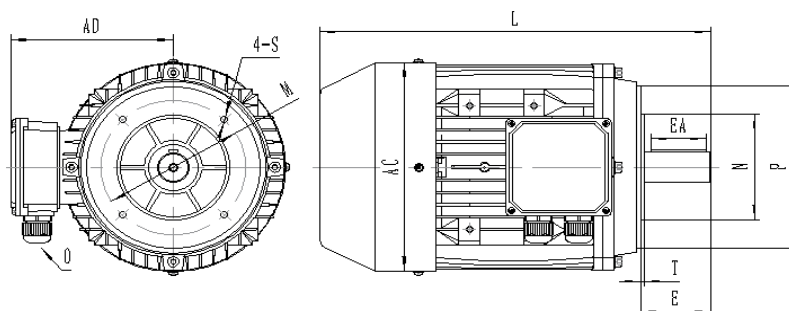

Frame Size	Pole	Dimensions					Dimensions			
		M	N	P	S	T	AC	AD	L	
80	2-8	100	80	120	4-M6	3	157	125	295	
90S	2-8	115	95	140	4-M8	3	177	138	355	
90L	2-8	115	95	140	4-M8	3	177	138	385	
100L	2-8	130	110	160	4-M8	3,5	205	150	440	
112M	2-8	130	110	160	4-M8	3,5	220	172	405	
132S	2-8	165	130	200	4-M10	4	256	192	455	
132M	2-8	165	130	200	4-M10	4	256	192	490	

IMB34 - IE3 - ALUMINIUM

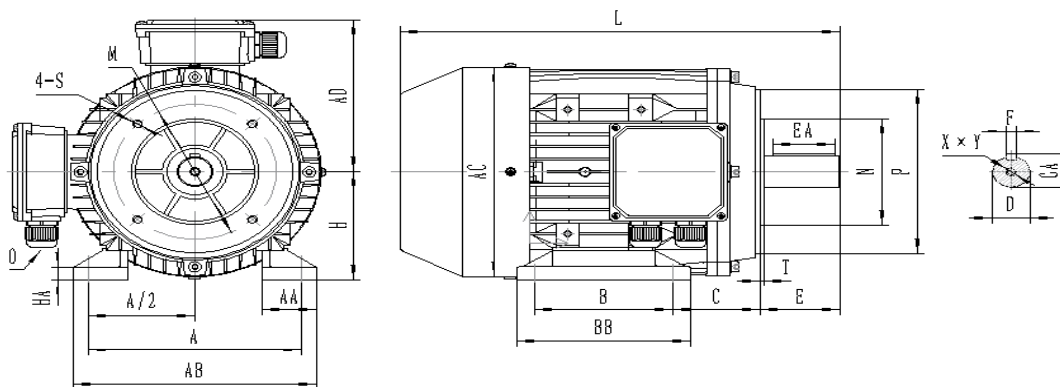

Frame Size	Pole	Dimensions												Dimensions							
		A	A/2	B	C	H	K	M	N	P	S	T	AA	AB	AC	AD	BB	HA	HD		L
																		Top	L&R		
80	2-6	125	62,5	100	50	80° _{-0,5}	10	100	80	120	4-M6	3	35	155	157	125	125	12	205	125	295
90S	2-6	140	70	100	56	90° _{-0,5}	10	115	95	140	4-M8	3	37	180	177	138	155	14	228	138	355
90L	2-6	140	70	125	56	90° _{-0,5}	10	115	95	140	4-M8	3	37	180	177	138	155	14	228	138	385
100L	2-6	160	80	140	63	100° _{-0,5}	12	130	110	160	4-M8	3,5	45	200	205	150	180	14	250	150	440
112M	2-6	190	95	140	70	112° _{-0,5}	12	130	110	160	4-M8	3,5	55	225	220	172	180	14	284	172	405
132S	2-6	216	108	140	89	132° _{-0,5}	12	165	130	200	4-M10	4	58	255	256	192	176	14	324	192	455
132M	2-6	216	108	178	89	132° _{-0,5}	12	165	130	200	4-M10	4	58	255	256	192	215	14	324	192	490

DIMENSIONE ALBERO - DIMENSION SHAFT

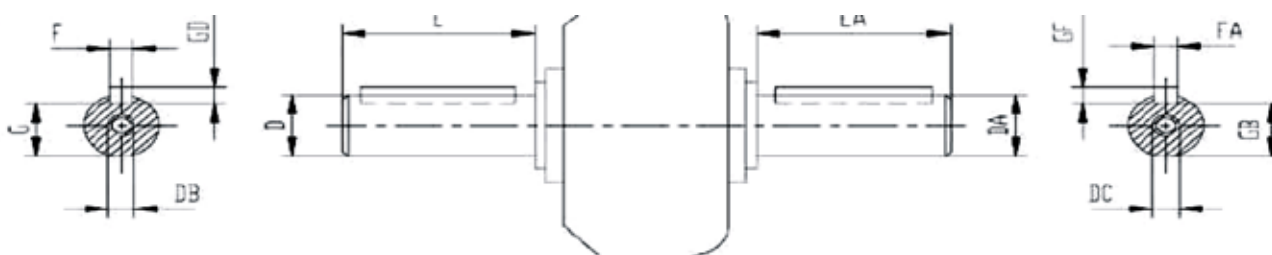

Frame	Pole	D	DA	E	EA	F	FA	G	GB	GD	GF	DB	DC
80	2-4-6	19 j6 ^(+0.009) _(-0.004)	19 j6 ^(+0.009) _(-0.004)	40	40	6	6	15:05	15:05	6	6	M6	M6
90S	2-4-6	24 j6 ^(+0.009) _(-0.004)	24 j6 ^(+0.009) _(-0.004)	50	50	8	8	20	20	7	7	M8	M8
90L	2-4-6												
100L	2-4-6	28 j6 ^(+0.009) _(-0.004)	28 j6 ^(+0.009) _(-0.004)	60	60			24	24			M10	M10
112M	2-4-6												
132S	2-4-6	38 k6 ^(+0.018) _(-0.002)	38 k6 ^(+0.018) _(-0.002)	80	80	10	10	33	33	8	8	M12	M12
132M	2-4-6												

IE3 CASTI RON HOUSING - TECHNICAL DATA

TYPE	Power KW	RPM r/min	Voltage		Amp	Amp	Efficiency 100%	Efficiency 75%	Efficiency 50%	Power Factor cosφ 100 %	Locked Current Is/In	Locked Torque Ts/Tn	Locked Torque Tm/Tn	Moment of inertia Kgm2	Weight Kg.
F3 160M-2	11	2940	400	690	20,0	11,6	91,2	91,3	88,5	0,87	8,10	2,00	2,30	0,051	125
F3 160MX-2	15	2940	400	690	27,1	15,7	91,9	92,0	89,1	0,87	8,10	2,00	2,30	0,064	136
F3 160L-2	18,5	2940	400	690	33,2	19,3	92,4	92,5	89,6	0,87	8,20	2,00	2,30	0,076	148
F3 180M-2	22	2950	400	690	38,9	22,6	92,7	92,8	89,9	0,88	8,20	2,00	2,30	0,117	189
F3 200L-2	30	2955	400	690	52,7	30,6	93,3	93,4	90,5	0,88	7,60	2,00	2,30	0,174	242
F3 200LX-2	37	2955	400	690	65,5	38,0	93,7	93,8	90,9	0,87	7,60	2,00	2,30	0,205	270
F3 225M-2	45	2960	400	690	77,6	45,0	94,0	94,1	91,2	0,89	7,70	2,00	2,30	0,302	328
F3 250M-2	55	2965	400	690	95,7	55,5	94,3	94,4	91,5	0,88	7,70	2,00	2,30	0,408	414
F3 280S-2	75	2975	400	690	129,9	75,3	94,7	94,8	91,9	0,88	7,10	1,80	2,30	0,799	541
F3 280M-2	90	2975	400	690	153,6	89,1	94,7	94,8	91,9	0,89	7,10	1,80	2,30	1,071	645
F3 315S-2	110	2980	400	690	183,3	106,2	95,2	95,3	92,3	0,91	7,10	1,80	2,30	2,031	900
F3 315M-2	132	2980	400	690	219,5	127,2	95,4	95,5	92,5	0,91	7,10	1,80	2,30	2,207	1025
F3 315L-2	160	2980	400	690	265,5	153,9	95,6	95,7	92,7	0,91	7,20	1,80	2,30	2,487	1160
F3 315LX-2	200	2980	400	690	331,1	192,0	95,8	95,9	92,9	0,91	7,20	1,80	2,20	2,907	1160
F3 355M-2	250	2980	400	690	413,9	240,0	95,8	95,9	92,9	0,91	7,20	1,60	2,20	3,812	1625
F3 355LX-2	315	2980	400	690	521,5	302,3	95,8	95,9	92,9	0,91	7,20	1,60	2,20	4,463	1750
F3 355LY-2	355	2980	400	690	587,8	340,7	95,8	95,9	92,9	0,91	7,20	1,60	2,20	4,463	1740

TYPE	Power KW	RPM r/min	Voltage		Amp	Amp	Efficiency 100%	Efficiency 75%	Efficiency 50%	Power Factor cosφ	Locked Current Is/In	Locked Torque Ts/Tn	Locked Torque Tm/Tn	Moment of inertia Kgm2	Weight Kg.
F3 160M-4	11	1470	400	690	21,4	12,4	91,4	91,5	88,7	0,81	7,70	2,20	2,30	0,107	138
F3 160L-4	15	1470	400	690	29,0	16,8	92,1	92,2	89,3	0,81	7,80	2,20	2,30	0,129	150
F3 180M-4	18,5	1470	400	690	35,2	20,4	92,6	92,7	89,8	0,82	7,80	2,00	2,30	0,190	186
F3 180L-4	22	1470	400	690	41,6	24,1	93,0	93,1	90,2	0,82	7,80	2,00	2,30	0,226	206
F3 200L-4	30	1475	400	690	55,1	31,9	93,6	93,7	90,8	0,84	7,30	2,00	2,30	0,361	269
F3 225S-4	37	1480	400	690	66,9	38,8	93,9	94,0	91,1	0,85	7,40	2,00	2,30	0,630	314
F3 225M-4	45	1480	400	690	81,1	47,0	94,2	94,3	91,4	0,85	7,40	2,00	2,30	0,738	356
F3 250M-4	55	1480	400	690	98,7	57,2	94,6	94,7	91,8	0,85	7,40	2,20	2,30	1,024	473
F3 280S-4	75	1490	400	690	134,1	77,7	95,0	95,1	92,2	0,85	6,90	2,00	2,30	2,083	620
F3 280M-4	90	1490	400	690	158,7	92,0	95,4	95,5	92,5	0,86	6,90	2,00	2,30	2,546	673
F3 315S-4	110	1485	400	690	193,5	112,2	95,4	95,5	92,5	0,86	7,00	2,00	2,20	3,490	875
F3 315M-4	132	1485	400	690	229,1	132,8	95,6	95,7	92,7	0,87	7,00	2,00	2,20	4,014	980
F3 315L-4	160	1485	400	690	277,1	160,6	95,8	95,9	92,9	0,87	7,10	2,00	2,20	5,236	1130
F3 315LX-4	200	1485	400	690	341,7	198,1	96,0	96,1	93,1	0,88	7,10	2,00	2,20	5,701	1185
F3 355M-4	250	1490	400	690	422,3	244,8	96,0	96,1	93,1	0,89	7,10	2,00	2,20	9,297	1660
F3 355LX-4	315	1490	400	690	532,2	308,5	96,0	96,1	93,1	0,89	7,10	2,00	2,20	10,286	1850
F3 355LY-4	355	1490	400	690	599,7	347,7	96,0	96,1	93,1	0,89	7,00	1,70	2,20	11,275	1865

TYPE	Power KW	RPM r/min	Voltage		Amp	Amp	Efficiency 100%	Efficiency 75%	Efficiency 50%	Power Factor cosφ	Locked Current Is/In	Locked Torque Ts/Tn	Locked Torque Tm/Tn	Moment of inertia Kgm2	Weight Kg.
F3 160M-6	7,5	970	400	690	16,6	9,6	89,1	89,2	86,4	0,73	7,00	2,00	2,10	0,117	122
F3 160L-6	11	970	400	690	23,8	13,8	90,3	90,4	87,6	0,74	7,20	2,00	2,10	0,177	144
F3 180L-6	15	975	400	690	30,1	17,4	91,2	91,3	88,5	0,79	7,30	2,00	2,10	0,316	201
F3 200L-6	18,5	980	400	690	36,9	21,4	91,7	91,8	88,9	0,79	7,30	2,00	2,10	0,468	243
F3 200LX-6	22	980	400	690	44,2	25,6	92,2	92,3	89,4	0,78	7,40	2,00	2,10	0,548	259
F3 225M-6	30	985	400	690	56,8	33,0	92,9	93,0	90,1	0,82	6,90	2,00	2,10	0,884	333
F3 250M-6	37	985	400	690	67,7	39,3	94,1	94,2	91,3	0,84	7,10	2,00	2,10	1,197	404
F3 280S-6	45	985	400	690	82,5	47,8	93,7	93,8	90,9	0,84	7,30	2,00	2,00	2,338	586
F3 280M-6	55	985	400	690	100,4	58,2	94,1	94,2	91,3	0,84	7,30	2,00	2,00	2,797	665
F3 315S-6	75	990	400	690	136,2	79,0	94,6	94,7	91,8	0,84	6,60	2,00	2,00	4,741	860
F3 315M-6	90	990	400	690	163,0	94,5	94,9	95,0	92,1	0,84	6,70	2,00	2,00	5,823	980
F3 315L-6	110	990	400	690	198,8	115,2	95,1	95,2	92,2	0,84	6,70	2,00	2,00	6,654	1050
F3 315LX-6	132	985	400	690	235,0	136,2	95,4	95,5	92,5	0,85	6,80	2,00	2,00	7,985	1100
F3 355M-6	160	990	400	690	284,2	164,8	95,6	95,7	92,7	0,85	6,80	1,80	2,00	10,386	1600
F3 355MY-6	200	990	400	690	354,5	205,5	95,8	95,9	92,9	0,85	6,80	1,80	2,00	12,413	1720
F3 355LX-6	250	990	400	690	438,0	253,9	95,8	95,9	92,9	0,86	6,80	1,80	2,00	13,933	1820



IMB3 - IE3 - CAST IRON

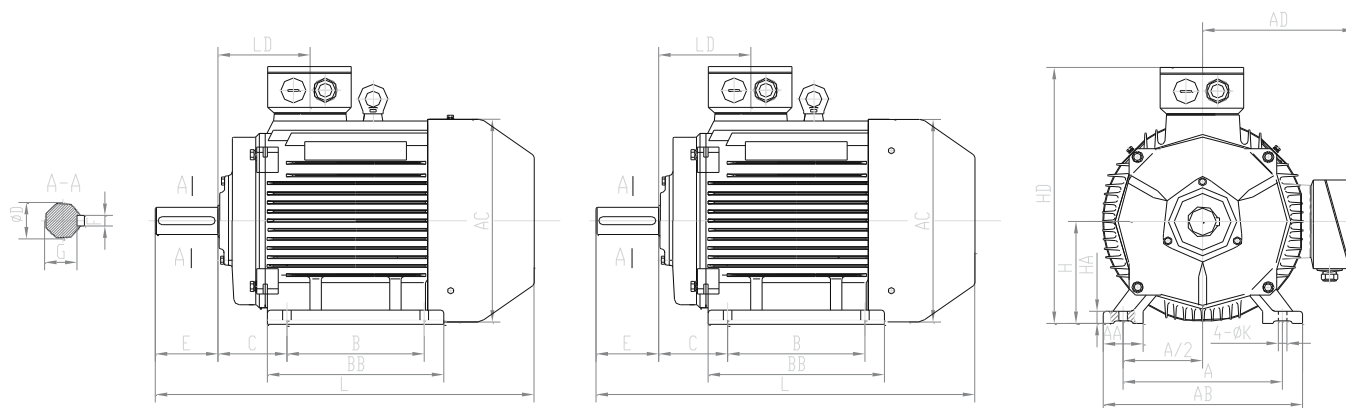

Frame Size	Pole	Dimensions							Dimensions								
		A	B	B1	B2	C	H	K	AA	AB	AC	AD	BB	HA	HD on top	LD	L
160M/L	2-6	254	210	254	-	108	160° _{-0,5}	15	65	315	315	265	305	20	411	146	627
180M	2-6	279	241	-	-	121	180° _{-0,5}	15	70	350	360	280	315	22	450	161	665
180L	4-6	279	279	-	-	121	180° _{-0,5}	15	70	350	360	280	350	22	450	161	705
200L	2	318	305	-	-	133	200° _{-0,5}	19	70	390	400	310	370	25	500	186	738
200L	4-6	318	305	-	-	133	200° _{-0,5}	19	70	390	400	310	370	25	500	186	758
225S	4-6	356	286	-	-	149	225° _{-0,5}	19	75	435	450	335	370	28	555	189	793
225M	2	356	311	-	-	149	225° _{-0,5}	19	75	435	450	335	395	28	555	189	775
	4-6	356	311	-	-	149	225° _{-0,5}	19	75	435	450	335	395	28	555	189	818
250M	2	406	349	-	-	168	250° _{-0,5}	24	80	485	490	375	445	30	625	207	870
	4-6	406	349	-	-	168	250° _{-0,5}	24	80	485	490	375	445	30	625	207	880
280S	2	457	368	-	-	190	280° _{-1,0}	24	85	545	550	405	490	35	670	215	950
	4-6	457	368	-	-	190	280° _{-1,0}	24	85	545	550	405	490	35	670	215	1020
280M	2	457	419	-	-	190	280° _{-1,0}	24	85	545	550	405	540	35	670	215	1000
	4-6	457	419	-	-	190	280° _{-1,0}	24	85	545	550	405	540	35	670	215	1070
315S	2	508	406	-	-	216	315° _{-1,0}	28	120	630	625	560	570	45	870	257	1180
	4-6	508	406	-	-	216	315° _{-1,0}	28	120	630	625	560	570	45	870	257	1185
315M/L	2	508	457	508	-	216	315° _{-1,0}	28	120	630	625	560	680	45	870	257	1279
	4-6	508	457	508	-	216	315° _{-1,0}	28	120	630	625	560	680	45	870	257	1323
355ML	2	610	500	560	630	254	355° _{-1,0}	28	120	730	710	615	750	52	956	284	1526
	4-6	610	500	560	630	254	355° _{-1,0}	28	120	730	710	615	750	52	956	284	1556

IMB5 - IE3 - CAST IRON

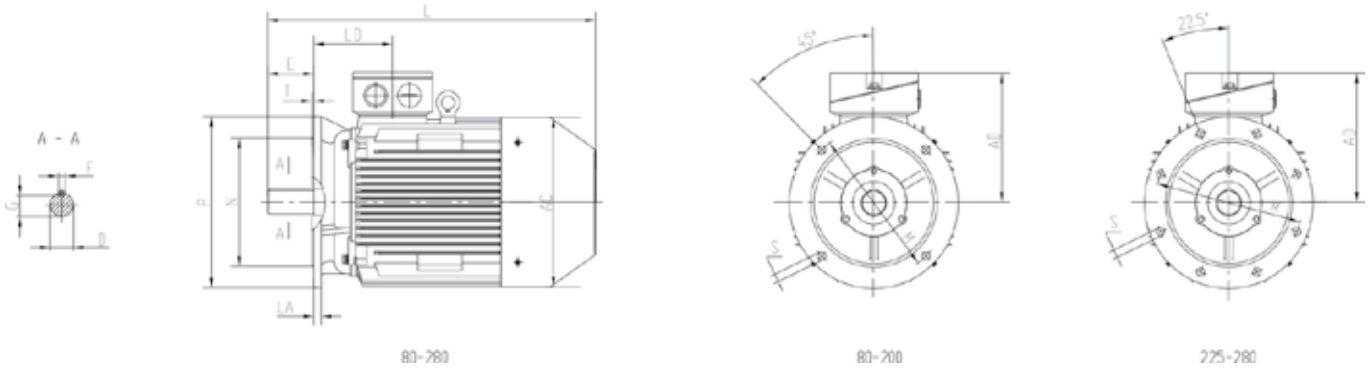

Frame Size	Pole	Dimensions					Dimensions				
		M	N	P	S	T	AC	AD	LA	LD	L
160M/L	2-6	300	250	350	4- Φ 19	5	315	265	15	146	627
180M	2-6	300	250	350	4- Φ 19	5	360	280	15	161	665
180L	4-6	300	250	350	4- Φ 19	5	360	280	15	161	705
200L	2	350	300	400	4- Φ 19	5	400	310	17	186	738
200L	4-6	350	300	400	4- Φ 19	5	400	310	17	186	758
225S	4-6	400	350	450	8- Φ 19	5	450	330	20	189	793
225M	2	400	350	450	8- Φ 19	5	450	330	20	189	775
	4-6	400	350	450	8- Φ 19	5	450	330	20	189	818
250M	2	500	450	550	8- Φ 19	5	490	375	22	207	870
	4-6	500	450	550	8- Φ 19	5	490	375	22	207	880
280S	2	500	450	550	8- Φ 19	5	550	405	22	215	950
	4-6	500	450	550	8- Φ 19	5	550	405	22	215	1020
280M	2	500	450	550	8- Φ 19	5	550	405	22	215	1000
	4-6	500	450	550	8- Φ 19	5	550	405	22	215	1070

IMB3/B5 - IE3 - CAST IRON

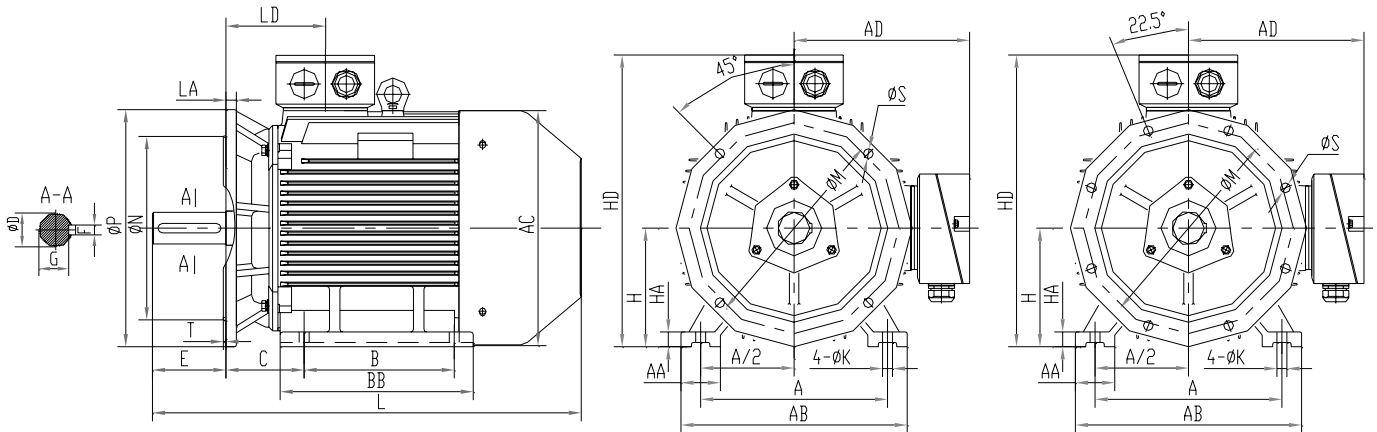

Frame Size	Pole	Dimensions													Dimensions										
		A	B	B1	B2	C	H	K	M	N	P	S	T	AA	AB	AC	AD	BB	HA	HB	HD		LA	LD	L
																					Top	L&R			
160M/L	2-6	254	210	254		108	160° _{-0.5}	15	300	250	350	4-Ø19	5	65	315	315	265	305	20	81	411	385	15	146	627
180M	2-6	279	241	-		121	180° _{-0.5}	15	300	250	350	4-Ø19	5	70	350	360	280	315	22	105	450	420	15	161	665
180L	4-6	279	279	-		121	180° _{-0.5}	15	300	250	350	4-Ø19	5	70	350	360	280	350	22	105	450	420	15	161	705
200L	2	318	305	-		133	200° _{-0.5}	19	350	300	400	4-Ø19	5	70	390	400	310	370	25	85	500	475	17	186	738
200L	4-6	318	305	-		133	200° _{-0.5}	19	350	300	400	4-Ø19	5	70	390	400	310	370	25	85	500	475	17	186	758
225S	4-6	356	286	-		149	225° _{-0.5}	19	400	350	450	8-Ø19	5	75	435	450	335	370	28	110	555	535	20	189	793
225M	2	356	311	-		149	225° _{-0.5}	19	400	350	450	8-Ø19	5	75	435	450	335	395	28	110	555	535	20	189	775
	4-6	356	311	-		149	225° _{-0.5}	19	400	350	450	8-Ø19	5	75	435	450	335	395	28	110	555	535	20	189	818
250M	2	406	349	-		168	250° _{-0.5}	24	500	450	550	8-Ø19	5	80	485	490	375	445	30	110	625	570	22	207	870
	4-6	406	349	-		168	250° _{-0.5}	24	500	450	550	8-Ø19	5	80	485	490	375	445	30	120	625	570	22	207	880
280S	2	457	368	-		190	280° _{-1.0}	24	500	450	550	8-Ø19	5	85	545	550	405	490	35	142	670	660	22	215	950
	4-6	457	368	-		190	280° _{-1.0}	24	500	450	550	8-Ø19	5	85	545	550	405	490	35	142	670	660	22	215	1020
280M	2	457	419	-		190	280° _{-1.0}	24	500	450	550	8-Ø19	5	85	545	550	405	540	35	142	670	660	22	215	1000
	4-6	457	419	-		190	280° _{-1.0}	24	500	450	550	8-Ø19	5	85	545	550	405	540	35	142	670	660	22	215	1070
315S	2	508	406	-		216	315° _{-1.0}	28	600	550	660	8-Ø24	6	120	630	625	530	570	45	110	870	750	22	257	1108
	4-6	508	406	-		216	315° _{-1.0}	28	600	550	660	8-Ø24	6	120	630	625	530	570	45	110	870	750	22	257	1185
315M/L	2	508	457	508		216	315° _{-1.0}	28	600	550	660	8-Ø24	6	120	630	625	530	680	45	110	870	750	22	257	1279
	4-6	508	457	508		216	315° _{-1.0}	28	600	550	660	8-Ø24	6	120	630	625	530	680	45	110	870	750	22	257	1323
355ML	2	610	500	560	630	254	355° _{-1.0}	28	740	680	800	8-Ø24	6	120	730	710	615	750	52	125	956	830	25	284	1526
	4-6	610	500	560	630	254	355° _{-1.0}	28	740	680	800	8-Ø24	6	120	730	710	615	750	52	125	956	830	25	284	1556

IMV1 - IE3 - CAST IRON

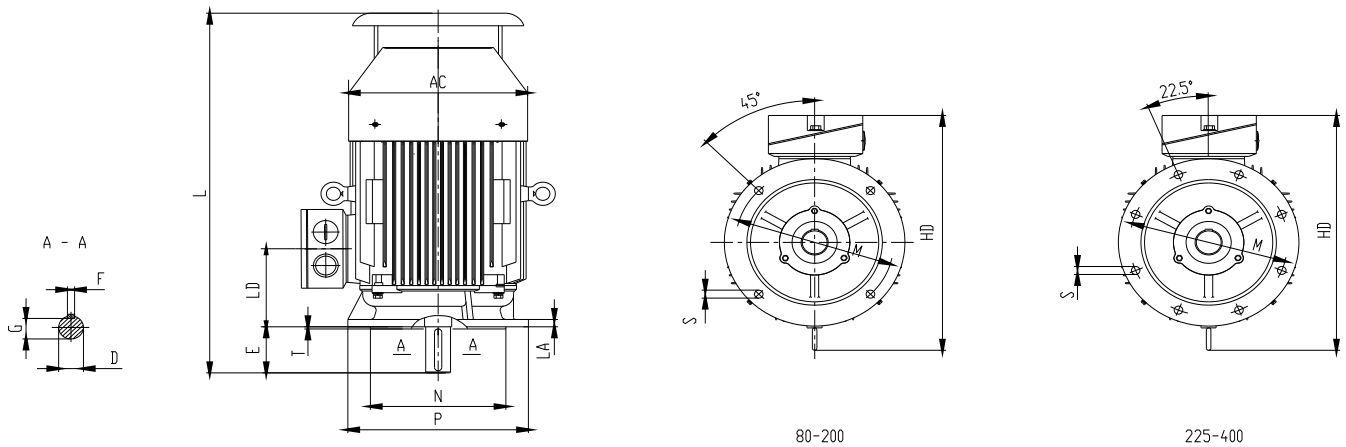

Frame Size	Pole	Dimensions				Dimensions					
		M	N	P	S	T	AC	HD	LA	LD	L
160M/L	2-6	300	250	350	4- Φ 19	5	315	476	15	146	680
180M	2-6	300	250	350	4- Φ 19	5	360	510	15	161	710
180L	4-6	300	250	350	4- Φ 19	5	360	510	15	161	770
200L	2	350	300	400	4- Φ 19	5	400	565	17	186	818
200L	4-6	350	300	400	4- Φ 19	5	400	565	17	186	838
225S	4-6	400	350	450	8- Φ 19	5	450	620	20	189	887
225M	2	400	350	450	8- Φ 19	5	450	620	20	189	873
	4-6	400	350	450	8- Φ 19	5	450	620	20	189	942
250M	2	500	450	550	8- Φ 19	5	490	695	22	207	971
	4-6	500	450	550	8- Φ 19	5	490	695	22	207	1005
280S	2	500	450	550	8- Φ 19	5	550	755	22	215	1071
	4-6	500	450	550	8- Φ 19	5	550	755	22	215	1138
280M	2	500	450	550	8- Φ 19	5	550	755	22	215	1116
	4-6	500	450	550	8- Φ 19	5	550	755	22	215	1193
315S	2	600	550	660	8- Φ 24	6	625	985	22	257	1329
	4-6	600	550	660	8- Φ 24	6	625	985	22	257	1345
315M/L	2	600	550	660	8- Φ 24	6	625	985	22	257	1453
	4-6	600	550	660	8- Φ 24	6	625	985	22	257	1483
355ML	2	740	680	800	8- Φ 24	6	710	1001	25	284	1665
	4-6	740	680	800	8- Φ 24	6	710	1001	25	284	1700

DIMENSIONE ALBERO - SHAFT DIMENSION

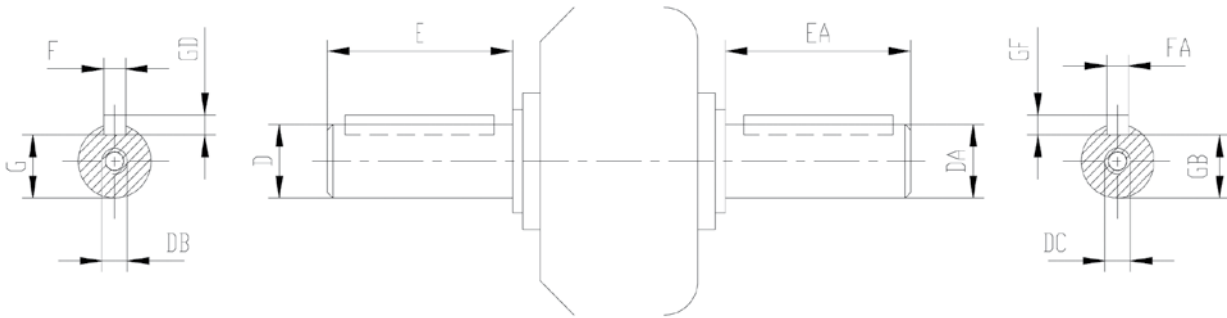

Frame	Pole	D	*DA	E	*EA	F	*FA	G	*GB	GD	*GF	DB-DC				
160M	2-4-6	42 k6	42 k6	110	110	12	12	37	37			M16x36				
160L																
180M	2-4-6	48 k6	48 k6			14	14	42,5	42,5	9	9					
180L																
200L	2-4-6	55 m6	55 m6	140	140	16	16	49	49	10	10	M20x42				
225S	4-6	60 m6	55 m6	110	110	18	16	53	49	11	10					
225M	2	55 m6	48 k6	140	140	16	14	49	45,5	10	9					
	4-6	60 m6	55 m6					140	140	18	16		53	49	11	10
250M	2	60 m6		140	140	18	16						53	49	11	10
	4-6	65 m6											58	49		
280S	2	65 m6	65 m6	140	140	20	18	58	49	11	10					
	4-6	75 m6						67,5	53	12	11					
280M	2	65 m6	55 m6	140	140	18	16	58	49	11	10					
	4-6	75 m6	65 m6					67,5	53	12	11					
315S	2	65 m6	65 m6	140	140	18	18	58	58	11	11					
	4-6	80 m6	80 m6	170	170	22	22	71	71	14	14					
315ML	2	65 m6	65 m6	140	140	18	18	58	58	11	11					
	4-6	80 m6	80 m6	170	170	22	22	71	71	14	14					
355ML	2	75 m6	75 m6	140	140	20	20	67,5	67,5	12	12	M24x50				
	4-6	100m6	100m6	210	210	28	28	90	90	14	14					

*Dimensions for NDE shaft, when it's requested, shall be confirmed with order agreement.

BEARINGS

Frame	D.E.	D.E.	D.E.	N.D.E.	N.D.E.	N.D.E.
	2 pole	4 pole	6 pole	2 pole	4 pole	6 pole
Aluminium						
FA3 80	6204 2RS C3	6204 2RS C3	6204 2RS C3	6204 2RS C3	6204 2RS C3	6204 2RS C3
FA3 90	6205 2RS C3	6205 2RS C3	6205 2RS C3	6205 2RS C3	6205 2RS C3	6205 2RS C3
FA3 100	6206 2RS C3	6206 2RS C3	6206 2RS C3	6206 2RS C3	6206 2RS C3	6206 2RS C3
FA3 112	6306 2RS C3	6306 2RS C3	6306 2RS C3	6206 2RS C3	6206 2RS C3	6206 2RS C3
FA3 132	6308 2RS C3	6308 2RS C3	6308 2RS C3	6208 2RS C3	6208 2RS C3	6208 2RS C3

Cast Iron						
F3 160	6309 ZZ C3	6309 ZZ C3	6309 ZZ C3	6309 ZZ C3	6309 ZZ C3	6309 ZZ C3
F3 180	6311 ZZ C3	6311 ZZ C3	6311 ZZ C3	6311 ZZ C3	6311 ZZ C3	6311 ZZ C3
F3 200	6312 ZZ C3	6312 ZZ C3	6312 ZZ C3	6312 ZZ C3	6312 ZZ C3	6312 ZZ C3
F3 225	6313 ZZ C3	6313 ZZ C3	6313 ZZ C3	6313 ZZ C3	6313 ZZ C3	6313 ZZ C3
F3 250	6314 C3	6314 C3	6314 C3	6314 C3	6314 C3	6314 C3
F3 280	6314 C3	6317 C3	6317 C3	6314 C3	6317 C3	6317 C3
F3 315	6317 C3	6319 C3	6319 C3	6317 C3	6319 C3	6319 C3
F3 355	6317 C3	6322 C3	6322 C3	6317 C3	6320 C3	6320 C3
F3 355	6317 C3	6322 C3	6322 C3	6317 C3	6320 C3	6320 C3

CABLE GLANDS

Aluminium	Ø Thread	Exit hole (mm)
FA3 80	M25x1,5	11...17
FA3 90	M25x1,5	11...17
FA3 100	M25x1,5	11...17
FA3 112	M25x1,5	11...17
FA3 132	M25x1,5	11...17
FA3 160	M40x1,5	19...28
Cast Iron		
F3 160	M40x1,5	19...28
F3 180	M40x1,5	19...28
F3 200	M50x1,5	26...35
F3 225	M50x1,5	26...35
F3 250	M63x1,5	32...48
F3 280	M63x1,5	32...48
F3 315	M63x1,5	32...48
F3 355	M72x2	///

All data listed in the tables are indicative and not binding. The guaranteed values are upon request. Felm srl reserves the right to change the project, the technical characteristics and dimensions at any time without previous notice.

PERMISSIBLE AXIAL LOADS

The following table gives the permissible axial forces in Newton, assuming zero radial force. In this case motor should be ordered with standard ball bearings. In case of higher axial force than given in the table an angular contact bearing should be ordered. The values are based on normal conditions at 50Hz. and calculated at 20000 working hour for two pole motors and 40000 hours for 4, 6 and 8 pole motors. At 60Hz. the values must be reduced by 10%. For two-speed motors the values have to be based at the higher speed. Fpressure (D.E.) is calculated for a fixed bearing at the Drive End.

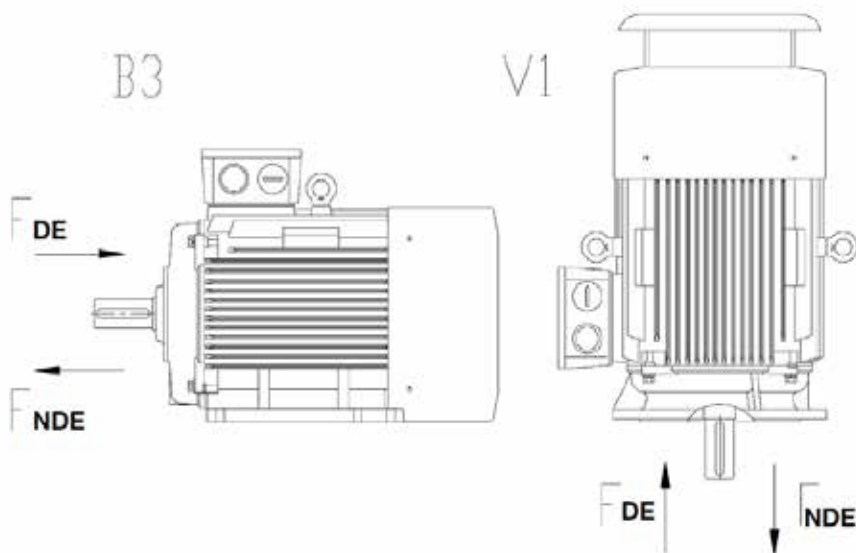

Frame Size	pole	Maximum axial force (FA)			
		B3 FDE	B3 FNDE	V1 FDE	V1 FNDE
80	2	380	380	400	360
	4	470	470	490	450
	6	590	590	620	560
	8	620	620	650	595
90	2	440	440	470	410
	4	550	550	600	510
	6	620	620	680	460
100	2	610	610	670	570
	4	750	750	840	710
	6	880	880	970	820
112	2	1220	1220	1300	1170
	4	1440	1440	1520	1370
	6	1650	1650	1740	1580
132	2	1500	1500	1620	1430
	4	1780	1780	1970	1610
	6	1820	1820	2000	1660
160	2	1650	1650	1950	1350
	4	2100	2100	2470	1720
	6	2450	2450	2800	2050
180	2	2100	2100	2450	1720
	4	2600	2600	3200	2000
	6	2900	2900	3510	2280
	8	3170	3170	3780	2550

Frame Size	pole	Maximum axial force (FA)			
		B3 FDE	B3 FNDE	V1 FDE	V1 FNDE
200	2	2400	2400	2940	1840
	4	3120	3120	3850	2390
	6	3480	3480	4350	2610
	8	3950	3950	4810	3090
225	2	2720	2720	3420	2020
	4	2480	3480	4370	2590
	6	2890	3890	5040	2820
250	2	3100	3100	3940	2260
	4	3900	3900	5000	2800
	6	4450	4450	5570	3230
280	2	5300	3100	6500	2100
	4	6300	4400	7800	3000
	6	6700	4300	7900	2900
315	2	7100	5020	9100	3520
	4	5900	3800	8000	2000
	6	7100	5100	10700	3150
355*	2	7600	5800	11800	3500
	4	8100	6300	12500	4400
	6	6100	1850	14000	800
	8	9800	3900	18300	2500*
	6	10500	4700	20700	3500*
	8	12500	6000	21500	3600*

*= Data calculated with roll bearings

PERMISSIBLE RADIAL LOADS

The following table give the permissible radial forces in Newton, assuming zero axial force and standard ball bearings. In case of higher radial force than give in the table an enforced bearing should be ordered. The values are based on normal conditions at 50 Hz and calculated at 20 000 working hours for the two pole motors and 40 000 working hours for 4,6 and 8 poles. For 60 Hz the value must be reduced by 10%. For two speed motors, the values have to be based at the higher speed.

Pulley diameter:

when the desired bearing life has been determined, the minimum pulley diameter can be calculated with the following formula:

$$D_{min} = \frac{1.9 \times 10^7 \times k \times P_N}{n_N \times F_R}$$

D_{min} = diameter of the pulley (mm)

P = power of the motor (kW)

n = motor rated speed (r/min)

k = belt tension factor, $k=2.5$ for V-belt

$F_{R(x)}$ = permissible radial force (N)

$$F_R = F_{X0} - \frac{X}{E} (F_{X0} - F_{Xmax})$$

E = the length of the shaft diameter (mm.) in basic version

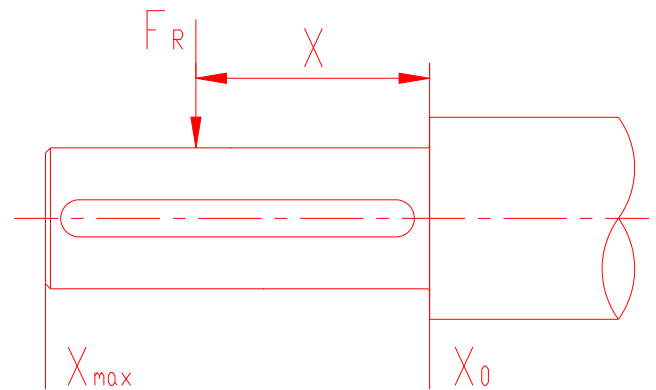

Frame Size	pole	Maximum radial force (FA)		
		X_0	$X_{1/2}$	X_{max}
80	2	670	610	550
	4	730	650	590
	6	830	750	680
	8	920	820	750
90	2	740	660	590
	4	800	710	630
	6	920	810	730
	8	1010	890	800
100	2	1030	920	820
	4	1110	990	890
	6	1270	1130	1020
	8	1400	1240	1120
112	2	1490	1330	1200
	4	1600	1430	1290
	6	1840	1640	1480
	8	2020	1800	1630
132	2	2160	1900	1690
	4	2330	2040	1820
	6	2670	2340	2080
	8	2940	2570	2290
160	2	2800	2440	2170
	4	3000	2630	2330
	6	3440	3010	2670
	8	3850	3410	3060
180	2	3930	3500	3150
	4	4240	3770	3390
	6	4890	4390	3980
	8	5380	4830	4380

Frame Size	pole	Maximum radial force (FA)		
		X_0	$X_{1/2}$	X_{max}
200	2	4480	4050	3700
	4	4820	4360	3980
	6	5520	5000	4560
	8	6080	5500	5020
225	2	5000	4540	4160
	4	5360	4720	4210
	6	6180	5480	4920
	8	6750	5940	5310
250	2	5680	5100	4620
	4	6120	5490	4980
	6	7000	6280	5700
	8	7710	6920	6270
280	2	5620	5080	4640
	4	7790	7050	6430
	6	8920	8060	7360
	8	9820	8880	8100
315	2	7370	6840	6390
	4	9150	8370	7720
	6	10480	9590	8830
	8	11530	10550	9720
355*	2	16330	15390	8730
	4	28300	25860	14290
	6	32400	29600	16350
	8	35660	32580	18000



CONTATCS

Head Quarter

FELM srl

Via Morandi (Industrial Area)

20010 Inveruno (Mi) Italy

Tel. +39 02 97 289 454

Tel. +39 02 97 288 320

Fax +39 02 97 289 923

E-mail home@felm.it



FELM Office Germany

Heinrich-Busold-Strasse 47

D-61169 Fridberg (Hessen), Germany

Tel. (Off.) +49 6031 721606

Mobile +49 172 6729011

E-mail Jayant@jk-conrep.de

FELM Office China

Room 1002, Building 3#, No.139 Rd. SongShan
Jianye, Nanjing, Jiangsu, China

Te. +86 150 778 29 999

Fax +86 25 87 797 622

E-mail lidongming1974@vip.sina.com

FELM Office Middle East

Al Saalam Street, Al Darwish Building (NBAD
building)

office no. 1403 Abu Dhabi (United Arab Emirates)

P.O. Box 45223

Office Ph. + 971-2-6710330

Office Fax + 971-2-6710255

mobile +971 50 4442093

WORLD WIDE SERVICE

Mobile +39 355 69 53 804

E-mail service@felm.it



ISO 14001



Certificate
EAC - CUTR
EurAseC
(Russian Market)