

ZTT40

2-WIRE DIN RAIL TRANSMITTERS

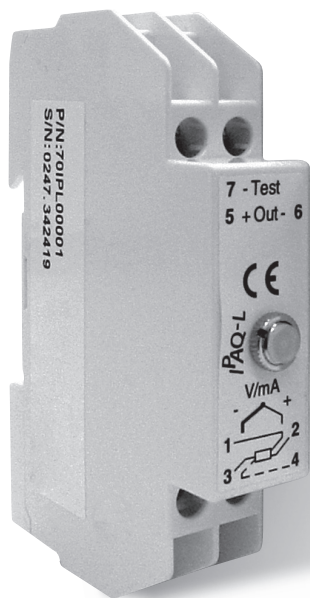

2. CONNECTION DIAGRAM

2.1 POWER SUPPLY AND OUTPUT

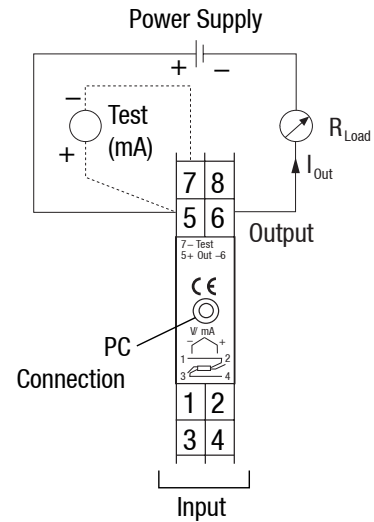

2.2 INPUT

Pt100, Pt1000,
Ni100, Ni1000,
4 wire connection

Pt100, Pt1000,
Ni100, Ni1000,
3 wire connection

Pt100
 ΔT
T2 > T1

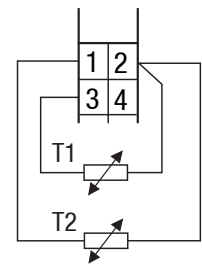
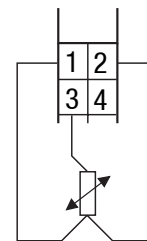
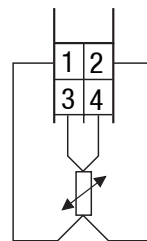

Potentiometer
4 wire sensor

Potentiometer
3 wire sensor

T/C Input

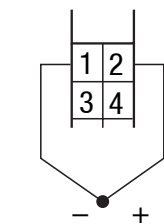
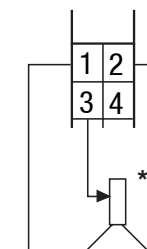
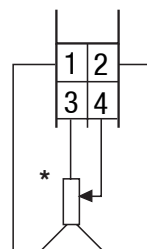

* Max. Input

* Max. Input

mV

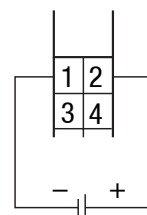

MESA INDUSTRIE - ELEKTRONIK GMBH

Neckarstraße 19, D-45768 Marl info@mesa-gmbh.de
Tel.: +49 (0)2365/97451-0, Fax: -25 www.mesa-gmbh.de

1. OUTLINE DIMENSIONS (mm)

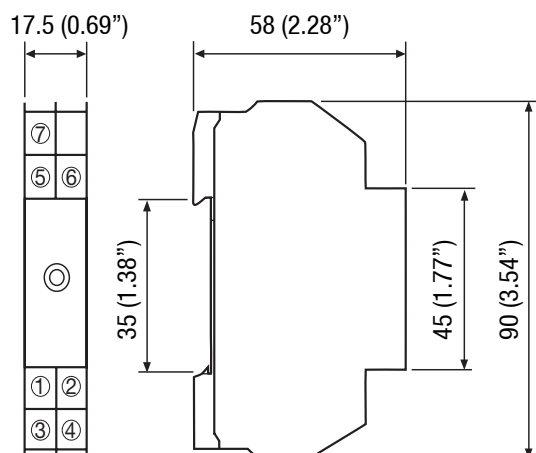

3. SPECIFICATIONS

Input		
RTD's and Resistance		
Pt100 (IEC751, $\alpha = 0.00385$)	3-, 4-wire connection	-200... +1000°C/-328... +1832°F
Pt1000 (IEC751, $\alpha = 0.00385$)	3-, 4-wire connection	-200... +200°C/ -328... +392°F
Ni100 (DIN 43760)	3-, 4-wire connection	-60... +250°C/-76... +482°F
Ni1000 (DIN 43760)	3-, 4-wire connection	-60... +150°C/-76... +302°F
Potentiometer/resistance	3-, 4-wire connection	0... 2000 Ω
Maximum sensor wire resistance		25 Ω /wire
Thermocouples, Voltage		
T/C	Type: AE, B, E, J, K, L, N, R, S, T, U	Ranges according to users manual
Voltage		-10... +500 mV
Input Impedance	T/C, Voltage	> 10 M Ω
Maximum sensor wire resistance	T/C, Voltage	500 Ω (total loop)
Monitoring		
Sensor break monitoring	User definable output	3.5... 21.6 mA
Adjustments		
Zero adjustment	All inputs	Any value within range limits
Minimum spans	Pt100, Pt1000, Ni100, Ni1000	10°C/18°F
	Potentiometer	10 Ω
	T/C, Voltage	2 mV
Output		
Straight, reversed or any intermediate value		4... 20/20... 4 mA
Resolution		5 μ A
Minimum output signal	Measurement/Failure	3.8 mA/3.5 mA
Maximum output signal	Measurement/Failure	20.5 mA/21.6 mA
Permissible load (see fig. 4)		750 Ω @ 24 VDC, 22 mA
Ambient Temperature		
Storage		-20... +70°C/-4... +158°F
Operation		-20... +70°C/-4... +158°F
General data		
Selectable dampening time		~2 s
Update time		~1.5 s
Isolation In - Out	Isolated versions	1500 VAC, 1 min
Humidity (non-condensing)		0... 95% RH
Power supply, polarity protected		
Supply voltage		7.5... 36 VDC 2-wire
Permissible ripple		4 Vp-p @ 50/60 Hz
Accuracy		
Linearity	RTD Potentiometer, mV	$\pm 0.1\%$ (note 1)
	T/C	$\pm 0.2\%$ (note 1)
Calibration	RTD	Max. of $\pm 0.2^\circ\text{C}/\pm 0.4^\circ\text{F}$ or $\pm 0.1\%$ (note 1)
	Potentiometer	Max. of $\pm 0.1 \Omega$ or $\pm 0.1\%$ (note 1)
	mV, T/C	Max. of $\pm 20 \mu\text{V}$ or $\pm 0.1\%$ (note 1)
Cold Junction Compensation (CJC)	T/C	$\pm 0.5^\circ\text{C}/\pm 0.9^\circ\text{F}$
Temperature influence (note 4)	All inputs	Max. of $\pm 0.25^\circ\text{C}/25^\circ\text{C}$ or $\pm 0.25\%/25^\circ\text{C}$ (note 1 and 3) Max. of $\pm 0.5^\circ\text{F}/50^\circ\text{F}$ or $\pm 0.28\%/50^\circ\text{F}$ (note 1 and 3)
Temperature influence CJC (note 4)	T/C	$\pm 0.5^\circ\text{C}/25^\circ\text{C}/\pm 1.0^\circ\text{F}/50^\circ\text{F}$
Instrument calibration output	4... 20 mA	$\pm 8 \mu\text{A}$
Sensor wire resistance influence	RTD, Potentiometer, 3-wire	Negligible (note 2)
	RTD, Potentiometer, 4-wire	Negligible
	mV, T/C	Negligible
Load influence		Negligible
Power supply influence		Negligible
RFI influence, 0.15... 1000 MHz, 10 V or V/m		$\pm 0.2\%$ (typical) (note 1)
Long-term stability		$\pm 0.1\%$ /year (note 1)
Housing		
Material/Flammability (UL)		PC + Glass fibre/V0
Mounting		Rail according to DIN EN 50022, 35 mm
Connection	Single/stranded wires	$\leq 1.5 \text{ mm}^2$, AWG 16
Weight		70 g
Protection, housing/terminals		IP 20/IP20

- Notes:**
- Of input span;
 - With equal wire resistance;
 - If zero-deflection > 100% of input span: add 0.125% of input span/25°C or 0.14% of input span/50°F per 100% zero-deflection;
 - Reference temperature 23°C/73°F.

3.2.1 Output Load Diagram

Fig. 4 - Permissible R_{Load} at 22 mA output

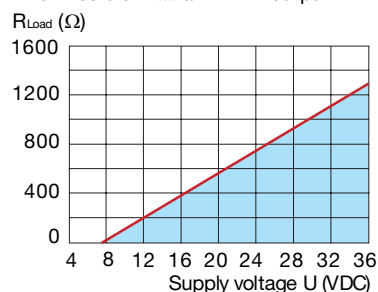

$$R_{\text{Load}} = (U - 7.5) / 0.022$$