

Without generating false alarms these detectors offer exceptional metrological performances

The design of this new generation of detectors provides 3 main features :
Performances / Guaranteed detection / Easy installation, use and maintenance.
With its interchangeable cartridge, this detector offers the choice of multi IR detection technologies (3xIR) or combined UV/IR (UV/2xIR).

Ne générant pas d'alarmes intempestives ces détecteurs offrent des performances métrologiques exceptionnelles



La conception de cette nouvelle génération de détecteurs repose sur 3 axes essentiels :
Performances / Garantie de détection / Facilité de mise en œuvre, d'exploitation et de maintenance.
Ce détecteur offre, par sa cartouche interchangeable, le choix des technologies de détection multi IR (3xIR) ou combinées UV/IR (UV/2xIR).

Detection quality
The efficiency of SIMRAD Optronics ICARE flame detectors offers : high sensitivity, a very short response time, reliability, immunity from interferences (hot sources, solar radiation, light sources...). It also guarantees protection against fire risks in industrial environments and enables the control of fire-fighting facilities. The housings are treated specifically to resist corrosive factors (316L stainless steel or aluminium housings).

High performances
Thanks to its microprocessor and algorithms, the removable detection cartridge (3xIR or UV/ 2xIR) optimises IR

detection and processes the alarm logic. These TV63 detectors have a wide viewing angle (> 80 m for the 3xIR with an angle of 110°). The integrated relays and a 4-20mA output enable the control of the TV63 by the central units (fire or gas) or by PLC.

Reliability
The detectors are equipped with an automatic test control, which regularly checks the functionality of the UV and the IR detection, as well as the optical and electronic integrity of the system.

Simplicity
The removable and interchangeable

cartridge (3xIR or UV / 2xIR) along with the wall mounting independent from the electronic box, makes this detector particularly simple to use.

Applications
Storage and use of flammable materials, petroleum, GNL/GPL, on shore / off shore, chemicals, industrial, aeronautic, automobile industry,...



Qualité de détection
L'efficacité des détecteurs de flamme SIMRAD Optronics ICARE : haute sensibilité, temps de réponse très court, fiabilité, immunité face aux interférents (sources chaudes, rayonnement solaire, sources lumineuses...) garantit une protection parfaite contre les risques de feu dans les environnements industriels et permet la commande de moyens d'extinction. Les boîtiers bénéficient d'un traitement spécifique pour une résistance aux agents corrosifs (boîtier INOX 316L ou aluminium).

Des performances élevées
La cartouche de détection interchangeable (3xIR ou UV / 2xIR) optimise la détection, grâce à son microprocesseur et ses algorithmes, et gère les logiques d'alarme. Les détecteurs TV63 disposent d'un très grand champs de vision (> à 80 m pour le 3xIR avec un angle d'ouverture de 110°). Les relais intégrés complétés par la sortie 4-20mA permettent l'exploitation du TV63 par les centrales (gaz ou incendie) ou directement par les automates industriels.

Fiabilité
Les détecteurs sont équipés d'un test de contrôle automatique qui vérifie, à intervalles réguliers, le bon fonctionnement de la détection UV / IR, ainsi que l'intégrité optique et électronique de l'ensemble.

Simplicité
La cartouche interchangeable débrochable permettant de changer de technologie (3xIR ou UV / 2xIR) ainsi que le support de fixation et d'orientation indépendant du boîtier électronique rendent ce détecteur particulièrement simple à installer et à maintenir.

Applications
Stockage et utilisation de matières inflammables, pétrole, GNL/GPL, on shore / off shore, chimie, industrie, aéronautique, automobile, etc.

The remote detectors give the optimum solution for maintenance operations by remote control.

The remote control
Our range of remote detectors constitutes an important advance in gas and fire detection technology. All configurations, tests and readouts are remotely accessible using the infrared remote controller. This tool, common to all SIMRAD Optronics ICARE remote detectors, allows test detection without using a test lamp and facilitates maintenance.

- Maintenance and configuration by a single operator
- Ease of use and reduced maintenance costs
- No need to use a test lamp
- Readout of status, settings and alarms
- Inhibition remote control
- Compatible with all remote detectors
- Certified intrinsically safe for use in restricted areas II 2 G/EEEx ia II C T6
- Safety in use



Les télécaptteurs apportent la solution la plus performante aux opérations de maintenance en permettant le contrôle à distance.

L'accès à distance
Les télécaptteurs représentent une évolution majeure dans le domaine de la détection de gaz et de flamme. La télécommande infrarouge pilote à distance et en toute sécurité les opérations de réglage, de test ou de visualisation. Cet outil, commun à tous les télécaptteurs SIMRAD Optronics ICARE, permet la réalisation d'essais de détection sans utiliser de lampe test et rend aisée la maintenance.

- Opération de maintenance et de paramétrage par un seul opérateur
- Simplicité d'utilisation et réduction des coûts de maintenance
- Dispense de l'utilisation d'une lampe test
- Lecture des états, paramètres et alarmes
- Commande d'inhibition à distance
- Universelle avec la totalité des télécaptteurs
- Agrément de sécurité intrinsèque pour une utilisation en zone classée II 2 G/EEEx ia II C T6
- Sécurité d'intervention

Detection distance on a normalized fire / Distances de détection sur feu normalisé
(Box / Bac : 0.3 x 0.3m) UV 2xIR : 45m • 3xIR : 80m

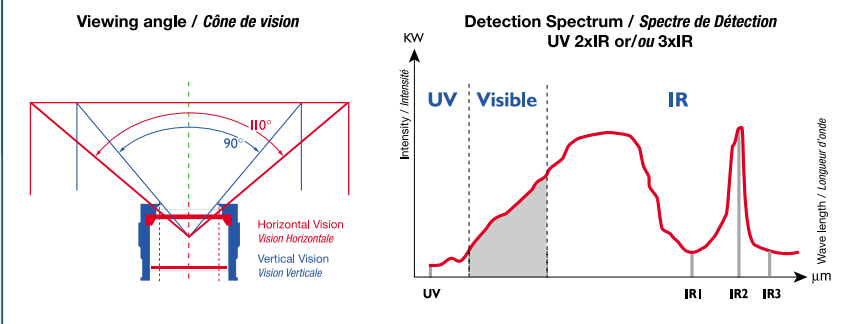

Manual

Remote controller TLU 600/610



CONTENTS

| | |
|---|----|
| 1. INTRODUCTION | 3 |
| 1.1. 1.1.IDENTIFICATION AND MARKING..... | 3 |
| 1.2. 1.2.FUNCTIONS..... | 4 |
| 1.3. 1.3.REMOTE CONTROLLER CONSTRUCTION | 5 |
| 2. CERTIFICATION | 7 |
| 3. OPERATION | 8 |
| 1.4. 3.1.SWITCHING ON | 8 |
| 1.5. 3.2.PASS WORD..... | 8 |
| 1.6. 3.3.MENU | 9 |
| 1.7. 3.4.PICTOGRAMS | 11 |
| 4. TECHNICAL SPECIFICATIONS | 15 |
| 5. MAINTENANCE..... | 15 |
| 1.8. 5.1.CLEANING | 15 |
| 1.9. 5.2.CHANGING A BATTERY UNIT | 15 |
| 6. PACKAGING AND TRANSPORT | 15 |
| 7. STORAGE..... | 15 |
| 8. Contact details..... | 19 |

INDEX OF FIGURES

| | |
|---|----|
| Figure 1: TLU Label | 3 |
| Figure 2: the remote controller..... | 5 |
| Figure 3: the remote controller key pad..... | 6 |
| Figure 4: connection established screen..... | 10 |
| Figure 5: connection to multiple sensors screen | 10 |
| Figure 6: battery charging indicator..... | 11 |
| Figure 7: low battery level indicator..... | 11 |
| Figure 8: connection indicator | 12 |
| Figure 9: good communication indicator | 12 |
| Figure 10: poor communication indicator | 13 |
| Figure 11: charging connection..... | 13 |

APPENDICES

| | |
|--|----|
| APPENDIX 1 : EC conformity declaration for TLU600..... | 16 |
|--|----|

1. INTRODUCTION

The TLU 600/610 remote controller is a portable terminal communicating with the SIMTRONICS DMiTT, DMiTO, DMiTX, DMiTK, DMiTT, DMiTV of the series 60, 61, 62, 63, 64 and 65, TI 40 (IREX) and TV 50 (UVIR) family of remote sensors and the DMiRT, DMiRO, DMiRX, DMiRK, DMiRT et DMiRV family of SIMTRONICS network remote sensors of the series 60, 61, 62, 63, 64 and 65.

The remote controller is intrinsically safe for use in explosive areas.

1.1. IDENTIFICATION AND MARKING

Model TLU 600 displays European (ASCII) characters, whilst model TLU 610 displays the Cyrillic alphabet.

The manufacturer's label, located at the back of the battery compartment, carries the following information:

- Manufacturer: SIMTRONICS
- Model: TLU 600 (European) or TLU 610 (Cyrillic display)

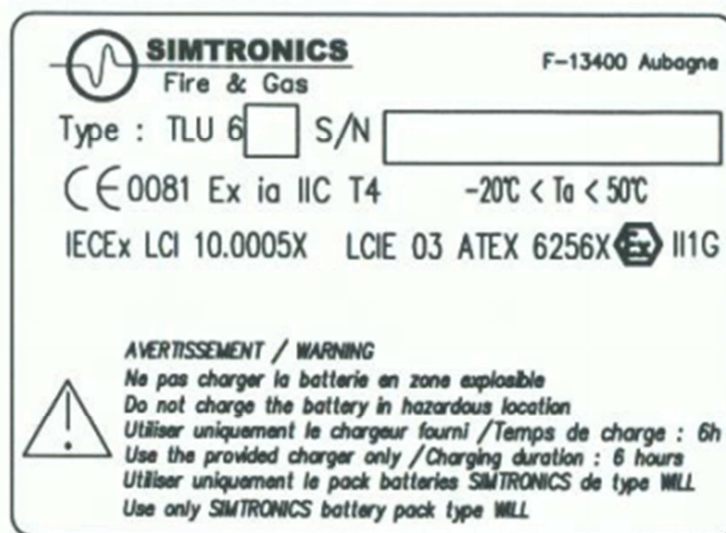

Figure 1: TLU Label

1.2. FUNCTIONS

The TLU 600/610 universal remote controller is used to exchange data with the remote sensor. This dialogue is based on a tree of on-screen menus and the use of function keys.

It simplifies every operation connected with maintenance, calibration, etc. The amount of usable functions will depend upon the remote sensor involved. For example, with the DMITT, DMITO, DMTT, DMTX and DMTK family of remote sensors, the remote controller can be used to calibrate, read current status, measure current, etc. For the flame detector, the remote controller can be used to stimulate a flame detection.

Similarly, the language used in these exchanges (French, English, etc.) will be that used by the remote sensor (except for the welcome screens).

From the Serie 63 of remote sensor, functions are password protected through various levels. The pass word used for the switching on of remote controller gives access to authorized functions.

The remote sensor and remote controller communicate by an infra-red link. Communication is therefore always by "line of sight", i.e. there must be no obstacle between the remote sensor and the remote controller.

The average communication distance is about 6 meters.

1.3. REMOTE CONTROLLER CONSTRUCTION

The remote controller includes:

- a case,
- a back-lit LCD screen displaying 4 lines of 20 characters,
- internal electronics,
- a buzzer,
- a battery unit compartment,
- a keypad with 18 keys including four function keys.

A charger is supplied with the remote controller.



Figure 2: the remote controller

The case is made up of two parts: the cover which carries the keypad, the main body which carries the LCD screen, electronics and charger connector, and the battery compartment.

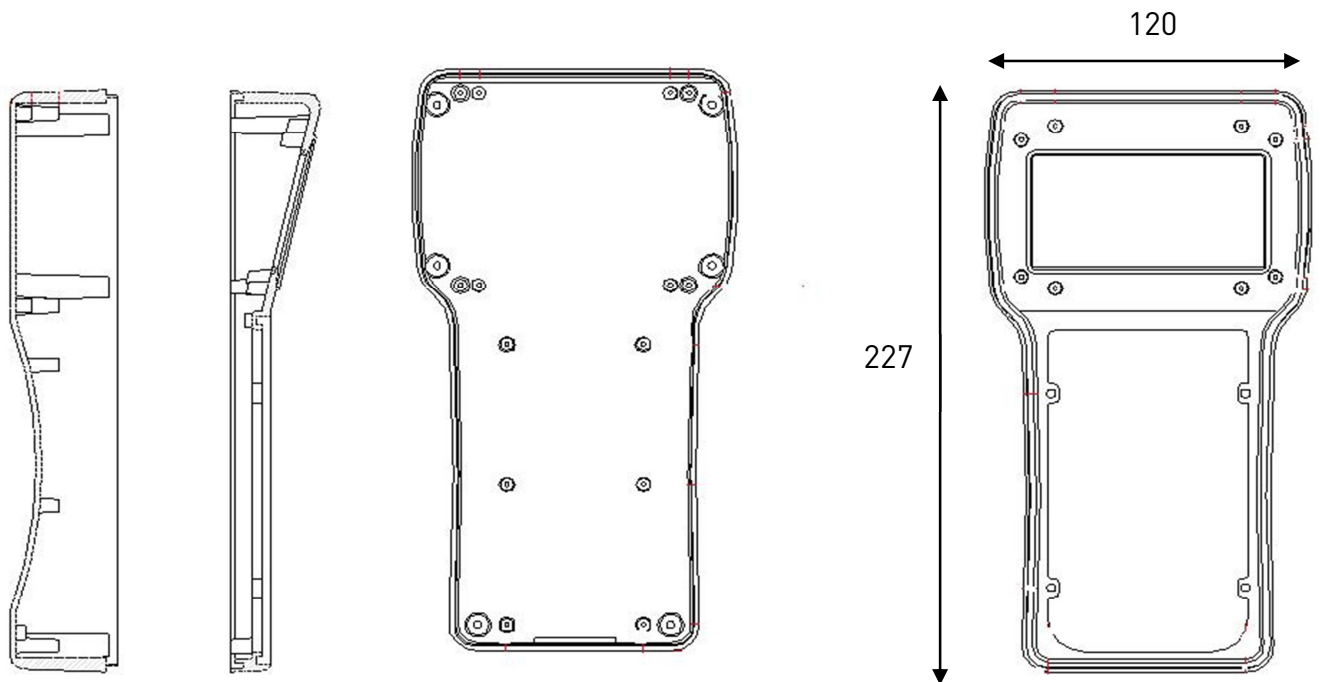

The case has an infra-red communication window at the front and a charger connector socket on the left-hand side.

The parts are assembled using cross-head self-tapping screws and the waterproofness is assured by charged seals graphite.

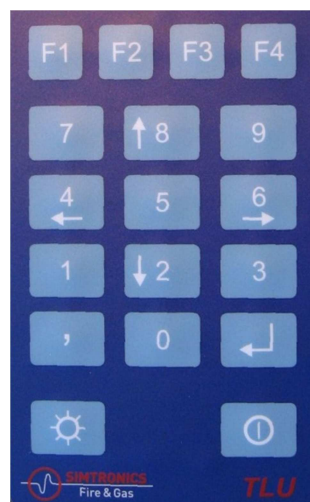

Figure 3: the remote controller key pad

The lower left button controls the backlighting of the LCD screen.

The lower right button is the remote controller ON/OFF.

The four functions keys are labelled *F1*, *F2*, *F3* and *F4*.

The central matrix comprises 12 keys: 0 to 9, comma and enter. Keys 2, 4, 6 and 8 are dual-function, acting also as up, down, right and left arrows.

2. CERTIFICATION

The equipment was designed and built to comply with the European directive 94/9/CE for products able to work in explosive atmosphere (usually called ATEX directive) which, for the certified devices is shown on the label by the symbol , the class of protection and the approval number obtained by a certified laboratory.

The compliance with this directive was obtained by the application of the following harmonized standards:

EN 60079-0 / IEC 60079-0

EN 60079-11 / IEC 60079-11

The equipment is also IEC Ex certified on the basis of the following standards:

IEC 60079-0

IEC 60079-11

3. OPERATION

3.1. SWITCHING ON

The remote controller is switched ON by pressing the ON/OFF key at the bottom right of the key pad (see Figure 2). The remote controller then runs a self-test routine. The character set is then displayed on the LCD screen, then gives access to the menus.

3.2. PASS WORD

From the Serie 63 (A type in the new references system), two safety levels protect the remote sensor functions:

- Level 1 called "USER"
- Level 2 called "MAINTENANCE"

The remote controller are despatched with the following pass words :

- Level 1 "USER" : one press at the bottom "enter"
- Level 2 "MAINTENANCE" "012345"

You can change the pass words. Their length is possible between 0 and 6 characters. You can valid the pass word pressing the bottom "enter" (the only one bottom to press in the case of 0 character).

3.2.1. COMPATIBILITY WITH THE OLD FAMILY BEFORE THE SERIE 63

Remote sensors before the Serie 63 are not protected with the safety levels. Whatever the pass word entered in the remote controller, the remote sensor gives access to the menus.

3.3.1. LANGUAGE CHOICE

To change the language of the remote controller :

- Go to the menu Setting/Language
- Choose English or French, then go out the menu pressing at the bottom "Esc" or "«". The remote sensor will recognize automatically the language from the Serie 63.

3.3.2. PASS WORD MODIFICATION

To change the pass word :

- Go to the Setting/Code
- Choose the access level to modify
- To be valid the pass word has to be entered twice

3.3.3. CONNECTION TO SENSOR

To connect to a sensor :

- Go to Scan Menu
- After the questioning phase, the remote controller displays the sensor list which answered
- Select a sensor with its number or launch again a Scan

When a sensor is selected, the remote control goes in REMOTE mode. The menus which appear are those of the selected télécaptur.

```

          C O N N E X I O N
1      G D 0 0 1
S E L : 1 . . 9      | F O R W | S C A N

```

Figure 4: connection established screen

In this example, the remote sensor carrying the label GD001 has been recognised by the remote controller.

The label is an 8 character identity chosen by the customer and allocated to the remote sensor during its manufacture in the SIMTRONICS factory.

Press key 1 to begin the dialogue with this remote sensor.

It may be that there is more than one sensor in the remote controller's field of view. A list of them will then appear on the screen as shown below:

```

          C O N N E X I O N
1 : G D 0 0 1
2 : D M T V 6 5
S E L : 1 . . 9      | F O R W | S C A N

```

Figure 5: connection to multiple sensors screen

Press function key F3 (FORW) to view the next remote sensor.

Each line is numbered. Press the key for that line number (1 to 9) to communicate with the corresponding remote sensor.

Up to this point, the menus have been in French. From this point onwards, the language used will be that programmed into the remote sensor (French, English, etc.).

A green LED in the remote sensor's infra-red head will, until this point, have been flashing at a frequency of about 0.5 Hz. From the moment you select this remote sensor, the flashing rate will increase to 1 Hz to indicate that communication has been established and will remain at this frequency throughout the dialogue. This makes it easier to identify the selected sensor, and shows that communication is taking place.

3.4. PICTOGRAMS

A number of symbols called pictograms are used to simplify TLU 600/610 operation.

These pictograms appear in the right-hand column (20th column of the screen).

3.4.1. CHARGE INDICATOR: " "

When the battery is charging, the "  " pictogram appears on the right of the screen as shown below:

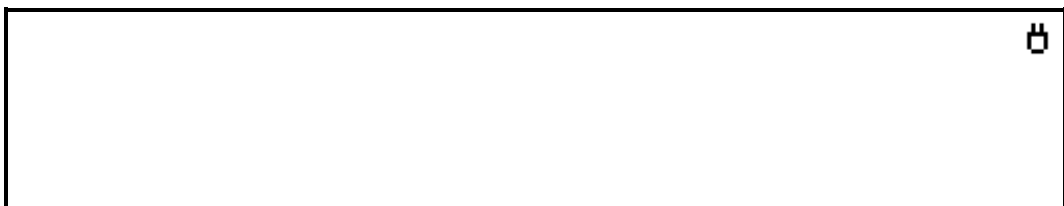

Figure 6: battery charging indicator

3.4.2. LOW BATTERY LEVEL INDICATOR: " "

When battery voltage falls to its lower limit, the "  " pictogram appears on the right of the screen as shown below:



Figure 7: low battery level indicator

The battery must then be recharged using the charger supplied. (see chapter 3.4.5: Battery recharging, page 13).

Do not continue to use the remote controller longer than half an hour after this symbol first appears without recharging the battery. To do so could damage the battery unit.

3.4.3. CONNECTION INDICATOR: "📶"

Once dialogue with the sensor has been established, the "📶" pictogram appears on the right of the screen. It remains on-screen until the connection is broken.



Figure 8: connection indicator

The connection may be broken in two ways:

- * Using the *FCNX* (End connection) menu. This is the normal way to end communication with a remote sensor.
- * You have moved your remote controller away from the sensor for more than 3 minutes. The remote sensor has closed the connection because it assumes that you have forgotten to use the *FCNX* menu to end the dialogue.

Once the connection is broken, the green LED on the remote sensor returns to flashing at around 0.5 Hz.

3.4.4. TARGETING INDICATOR: "📶", "📶"

Once dialogue is established with the remote sensor (connection indicator "📶" is displayed), the targeting indicator lets you know the quality of communication with the remote sensor.

When the "📶" symbol is displayed, the quality of communication is excellent.



Figure 9: good communication indicator

When the "📶" symbol replaces the one referred to above, communication is becoming difficult. If there is no indication, communication has been lost. If this happens, move closer to the remote sensor and make sure you are pointing the remote controller directly at it. If the sun is shining directly at the remote controller, you may need to shade the infra-red communication window at the front of the controller.



Figure 10: poor communication indicator

3.4.5. BATTERY RECHARGING

Only the charger supplied with the remote controller is to be used to recharge the battery; using any other charger risks permanent damage to the remote controller. It carries the label TLU600.

NEVER CHARGE THE BATTERY IN AN EXPLOSION RISK AREA.

The charger must never be used in an explosion risk area, nor must the remote controller when it is on charge.

To ensure optimum battery life, you should wait until the low battery charge indicator (🔋) appears and then recharge completely over.

The charger of the TLU600 is an automatic charger with fast load adapted specially.

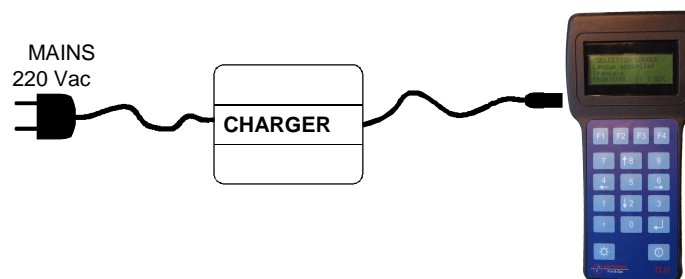

Figure 11: charging connection

- * Connect the charger with the main 100-240V AC 50-60Hz. The LED gets clearer in yellow (not connected battery)
- * Connect the charger with the remote controller. The LED remains yellow during some seconds during the initialization and test phase.
- * The LED gets clearer in orange during the fast charge which can last till two hours.
- * Switching in compensation charge, green/yellow blinking
- * Switching in slow charge, the LED gets clearer in green when the battery is charged.

In case of emergency, it's possible to interrupt the fast load to use the remote controller, but with a reduced battery capacity.

The battery can be subjected at some hours of slow load, without damage, but the permanent charge is not advised.

The energy source of the remote controller is a moulded block NiMH 7.2V nominal, 1800 mAh, joining safety elements and carrying the label bellow

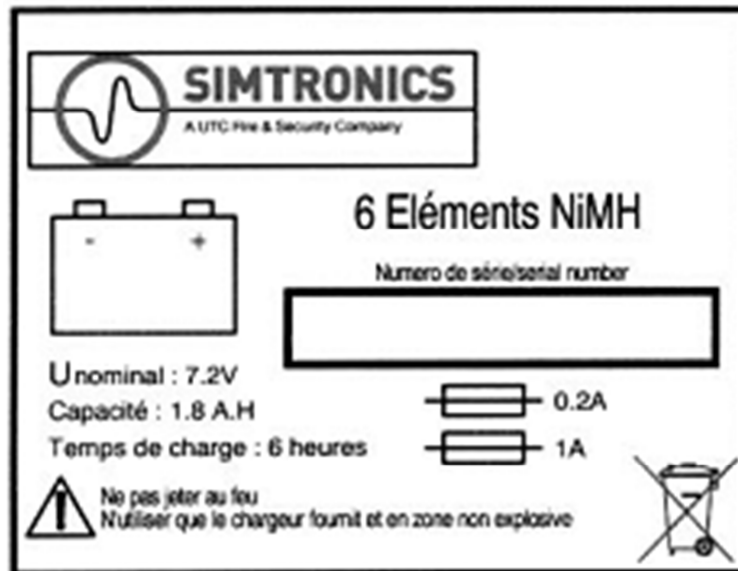

In case of failure of the block battery, it's necessary to replace the block by a same block battery, only supplied by Simtronics, to keep the ATEX protection

3.4.6. BACK-LIGHTING

The remote controller is fitted with a screen back-lighting system which provides excellent legibility regardless of ambient lighting conditions.

Back-lighting can be turned on and off using the button at the bottom left of the remote controller (see Figure 2, page 5).

3.4.7. AUTOMATIC CUT-OFF

The remote controller has an automatic cut-off system to conserve battery life.

This system is activated 3 minutes after the last key press or whenever the connection to a remote sensor has been broken for over 3 minutes.

4. TECHNICAL SPECIFICATIONS

- Operating temperature: -20°C to 50°C,
- Self-powered operation: 4 hours,
- Power supply: Rechargeable NiMH batteries,
- Dimensions (maxima): 230 Long x 120 Wide x 70 Deep,
- Weight: 0.85 kg.

5. MAINTENANCE

To be done out of ATEX area

5.1. CLEANING

Take care not to scratch the infra-red communication window.

5.2. CHANGING A BATTERY UNIT

To change the battery unit:

- remove the battery compartment by undoing the 6 cross-head screws.
- Disconnect the link connector.
- Change the unit.
- Reconnect the link cord making sure the connector is the right way round.
- Coil the cord into the space between the body and the battery unit.
- Refit the compartment using the 6 screws, taking care to avoid pinching the wires or damaging the waterproof seals.



6. PACKAGING AND TRANSPORT

Whenever the equipment is to be transported (for repair, etc.), it is advisable to pack the remote controller and its accessories in their original packaging.

7. STORAGE

Store the remote controller in a dry, dust-free area at a temperature in the range -25 to +50°C.

APPENDIX 1 : EC conformity declaration for TLU600

| | | |
|---|---|--------------------------------|
|  | DECLARATION OF EC CONFORMITY | Réf : +NOSP0014804 Rév. : 5 |
| <p>SIMTRONICS 792, Avenue de la Fleuride 13400 AUBAGNE - FRANCE</p> <p>We, SIMTRONICS, declare that the following equipment :</p> <p>REMOTE CONTROL TLU bearing the following marking : CE 0081  II 1 G / Ex ia IIC T4 -20°C ≤ Ta ≤ +50°C</p> <p>Is designed and manufactured in compliance with the following applicable Directives :</p> <ul style="list-style-type: none"> - ATEX Directive 94/9/EC <p>Compliance has been obtained by application of the following standards:</p> <p>EN 60079-0 (2006) EN 60079-11 (2007)</p> <p>For which an EC-Type Certificate LCIE 03 ATEX 6256X, and a notification LCIE 03 ATEX Q 8046 according to Annexe IV have been obtained.</p> <p>Low Voltage Directive 2006/95/EC is not applicable to this equipment.</p> <ul style="list-style-type: none"> - EMC Directive 2004/108/EC <p>Compliance has been obtained by application of the following standards :</p> <p>EN 50270 (2000)</p> <p>For which a self evaluation report has been issued.</p> <p>The notified body in charge of monitoring the ATEX Directive is :</p> <p>LCIE 33, Avenue du Général Leclerc 92260 FONTENAY AUX ROSES France</p> <p>Identification Number : 0081</p> <p>This equipment shall be used for the purpose for which it has been designed, in accordance with relevant standards and with manufacturer's recommendations.</p> <p>We, undersigned SIMTRONICS, declare that the product specified above conforms to the listed Directives and standards.</p> <p>Aubagne, April 28th, 2011</p> <div style="display: flex; justify-content: space-around; margin-top: 20px;"> <div data-bbox="220 1753 416 1805"> Salvator LA PIANA Plant Manager </div> <div data-bbox="788 1753 1023 1805"> Jean-Pierre RUSSIER Quality Manager </div> </div>   | | |

8. CONTACT DETAILS

You will find an updated list of distributors on our web pages:

www.simtronics.eu

Email address for general enquiries: mail@simtronics.no

Simtronics ASA

Kabelgaten 8, Økern Næringspark

PO Box 314, Økern, NO-0511 Oslo, Norway

Tel: +47 2264 5055

Simtronics SAS

792, av de la Fleuride

BP 11016, 13781 AUBAGNE CEDEX – FRANCE

Tel: +33 (0) 442 180 600

