



NEW High Performance Compact 2D Code Reader

SR-750 Series



High Performance Compact 1D and 2D Code Reader

high efficiency ensures stable reading of difficult codes

Black resin

Metal

PCB

Scratched

Misaligned

Curved surface

SR-750 Series

A New Algorithm Adopted for **Capture & Process** to Enable Stable Reading

Our original corrective capture and process techniques provide best-in-class reading capability even for difficult to read codes.



A newly adopted algorithm automatically selects the optimal settings from as many as 250,000 correction patterns.

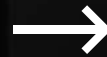

Capture

Automatically determine optimal reading conditions such as brightness and filtering to clarify all code types as possible before reading.

Process

A newly developed processing method ensures accurate black/white reproduction even for irregular codes.

Best in class

Reading Capability

A newly adopted algorithm provides best-in-class reading capability. Difficult codes can also be scanned stably, including those directly marked on uneven surfaces.



Easy Tuning

It is just as easy to operate as other SR Series readers so that anyone can readily start enjoying excellent reading performance. In addition, the optimal settings can be obtained in three simple steps through automatic tuning.



First in class

Preventative Maintenance

Image quality can be judged based on industrial standards.

It is also possible to output judgment results as signals so that you can understand clearly when maintenance is required in the printing process.

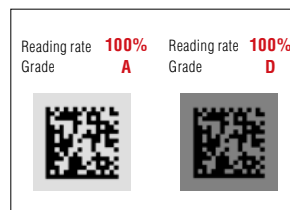

A New Algorithm Provides Best-in-class Reading Capability

Captures Codes Clearly

Automatically correct codes which are difficult to read due to print density or other marking conditions. Ensure optimal reading for any size, shape, or surface.

Capture Brightness Correction

Configure various settings for exposure time, dynamic range, and gain automatically in order to achieve ideal brightness level.

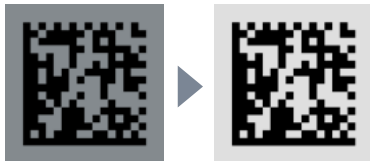

Example codes requiring brightness correction



Black resin

PCB

Brass

Contrast Threshold Correction

Automatically corrects black/white classification thresholds and optimizes the contrast between code and background.

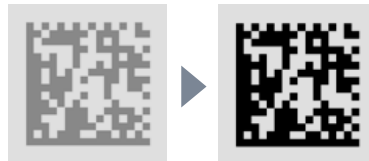

Example codes requiring threshold correction



Nylon resin

Low contrast

Ceramic

Image Reduction & Correction

Reduces the image size to ideal size in order to ensure the code captured can be easily decoded.



Correction through Filters

Automatically selects the best filter and filtering intensity to correct the captured image.



Example codes requiring filtering

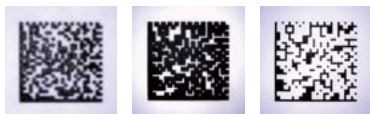

Bleeding

Thick printing

Thin printing

Geometric Correction

Corrects distorted codes, such as those found on cylinders.

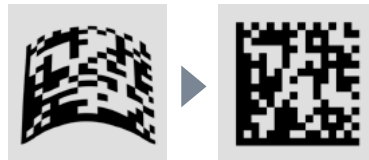

Example codes requiring geometric correction



Parallel distortion

Trapezoidal distortion

Tread barrel distortion

Example codes requiring image reduction



Primary noise

Dot printing

Stray dots

Process Captured Codes

Thanks to condition-based processing, read errors are reduced even if codes in captured images are difficult to read.

Contrast Algorithm for Local Concentration (CALC)

Conventionally, black/white thresholds are set for the entire code, which makes it difficult to detect unevenly printed codes. To solve this problem, we have developed a new Contrast Algorithm for Local Concentration, to allow thresholds to be set for each section of a code. This algorithm enables highly accurate black/white classification even for DPM codes, on which uneven print density often occurs.

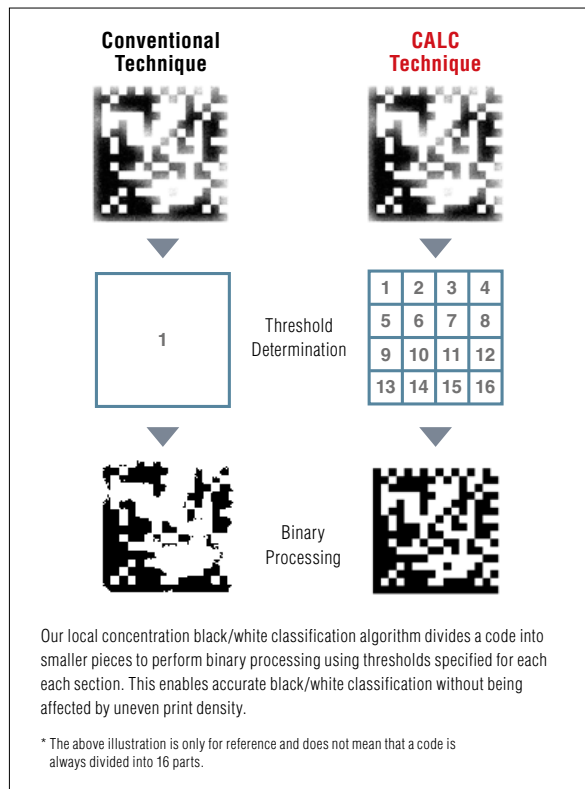

High Speed & High Stability Code Search

A newly developed Double HS (High Speed & High Stability) search program can detect a 2D code in the field of view immediately so that high-speed, stable search is ensured even when the code position changes or there are several 2D code-like patterns in the field of view.

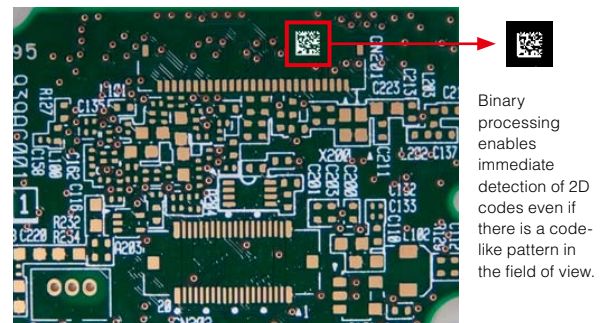

Defective Code Positioning Program

A newly developed defective code positioning program can identify four corners of a 2D code based on a similar code detection pattern, leading to a significant improvement in code detection performance.

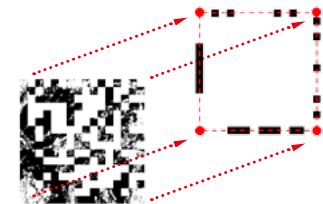

Example codes requiring new processing algorithms



High Performance with Easy Tuning

Three Step Simple Setup

Simple procedure easily configures the code reader. Even without prior experience, anyone can enable advanced reading capability with easy tuning through the setting software or on the main unit.

From the setting software

Setting Software: AutoID Network Navigator **SR-H3W**



- 1 **Laser-Aim**
Position the code
- 2 **Monitor**
Check the image
- 3 **Tuning**
Just click

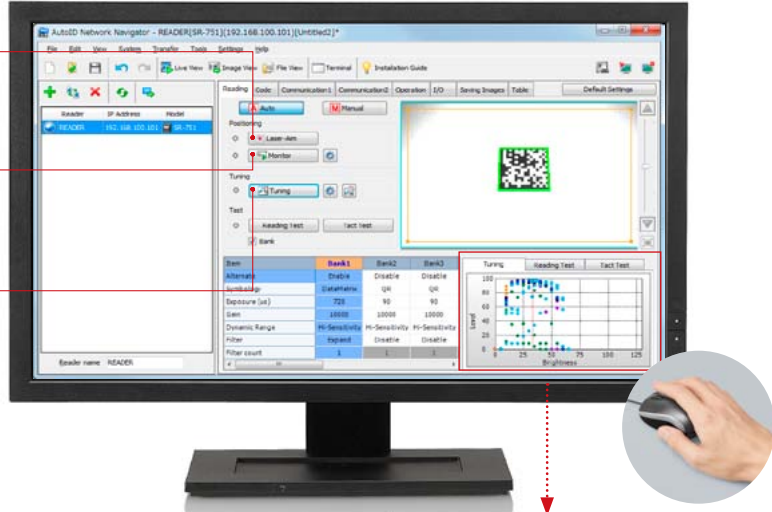

Reduces manhours for setup and troubleshooting with Live View

Reading test can be easily executed. Also check reading ratio, cycle time, and banks that are used for reading.

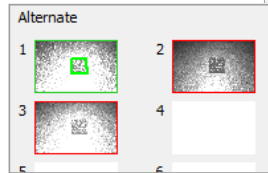

Check the preset codes.
[-> Parameter bank function See P. 9]

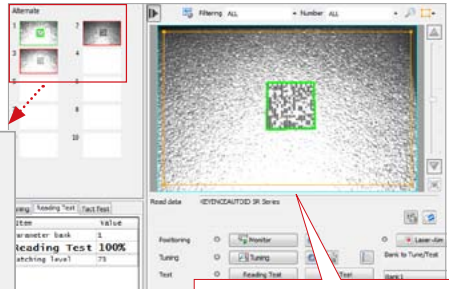

Check real-time images while tuning.

Automatic selection of optimal settings

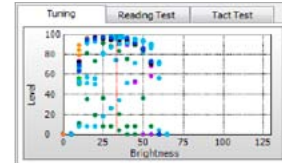

Automatically selects the optimal settings from various combinations of correction patterns, such as filters and brightness levels.

From the main unit



**TUNE button/
TEST button**

Activates tuning mode or test mode

Multi-LED display

Displays reading stability and bank numbers

1 POSITIONING

Use the laser pointer to position the code in the reading area



TUNE Push!

Converging lasers indicate focal point

2 TUNING

Automatically determines the optimal reading conditions



TUNE Push!

Searches reading conditions
Reading test

3 BANK REGISTRATION

Registers reading conditions to the main unit



TEST TUNE Push!

Selects bank number
Bank registration

Stable Operation with the Preventive Maintenance Function

Image Quality Check by Code Reader

The SR-750 Series is the first product in this class with scanned image quality judgment and threshold functions. This enables you to notice image deterioration before an error occurs, thus ensuring stable operation.

Matching Level Function

Enables Code Quality and Readability Thresholds

When a code is scanned successfully, the SR-750 determines the readability of the scanned code. This information can be used to check the reliability of scanning, as a correlation index for the parameter bank tuning, or to give feedback or information to product suppliers and customers.

Two codes, both having a reading rate of 100%, can still be distinguished by the matching level

Reading rate	100%	Reading rate	100%
Matching level	75	Matching level	43

The above shows that the left code has a higher matching level than the right one.

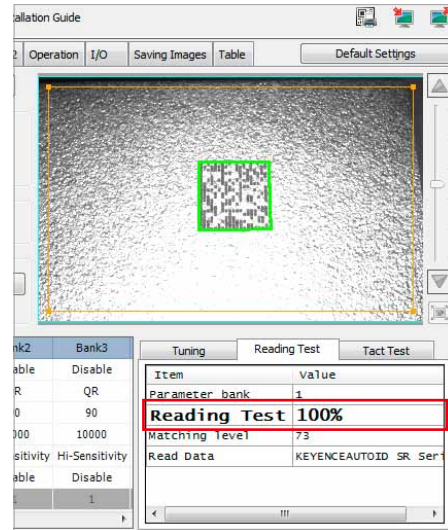

Target Code Verification Function

Verification based on industry printing or marking standards

Total grades can be appended based on various standards, and pass/fail thresholds for outputs can be applied as well. This function is designed for 2D codes (QR, DataMatrix).

Output data **AD-ERMT-55841:B**

Total grade judgment

Judgment can also be performed for each parameter



Supported Standards

- ISO/IEC 15415
- SAE AS9132
- ISO/IEC TR 29158 (AIM DPM-1-2006)
- SEMI T10-0701

The multi-I/O function outputs image verification results

Various operating conditions can be assigned to two input terminals and three output terminals.

Sample outputs of quality verification results

- OUT1: Stable read output (STABLE)**
- OUT2: Unstable read output (UNSTABLE)**
- OUT3: No read/read error output (ERROR)**

Any threshold level can be set for STABLE and UNSTABLE.

Compatible with a Wide Variety of Applications

Four Models and Dedicated Lens Attachments to Support Various Reading Conditions

The four models of the SR-750 Series cover a wide range of applications from reading minute codes printed on very small parts to reading codes from long distance. In addition, KEYENCE's Parameter Bank function enables stable reading even if the size or shape of the parts change.

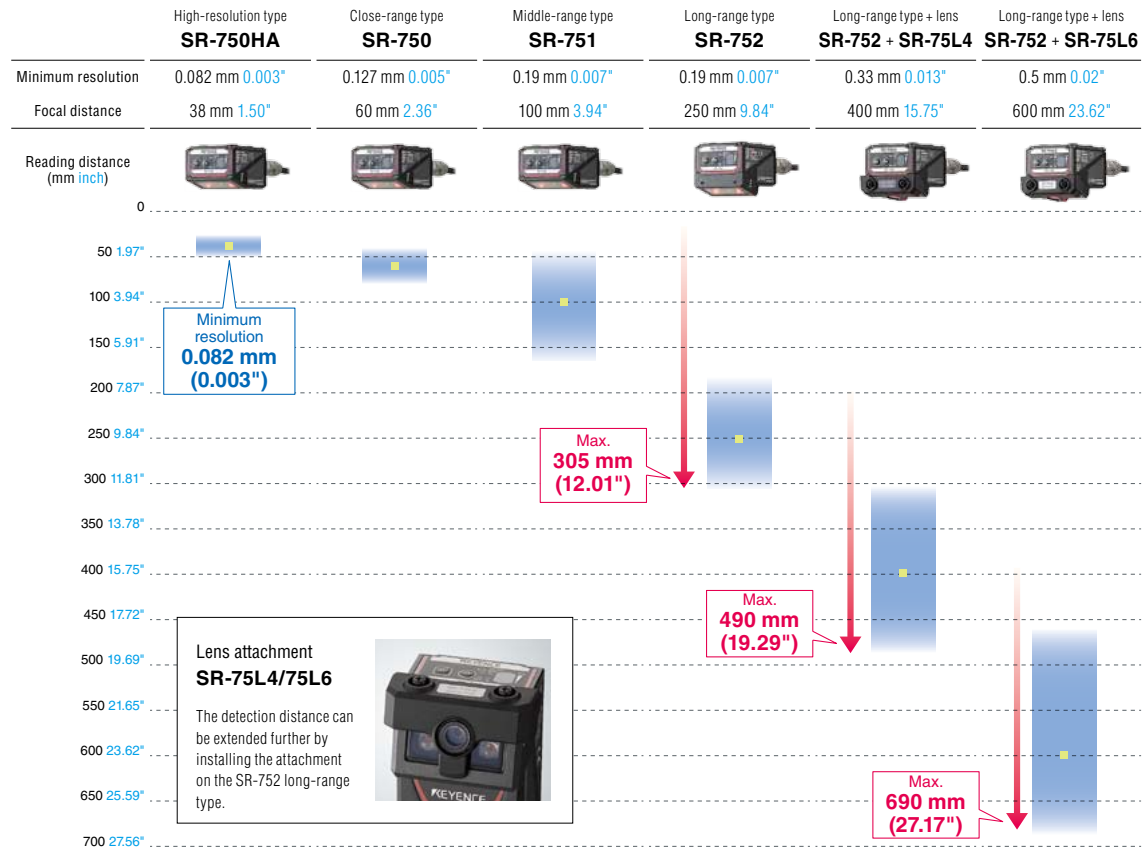

The reading range above is a value measured with a KEYENCE test label. Max. 305 mm 12.01", 490 mm 19.29", and 690 mm 27.17" are for DataMatrix (cell size 0.5 mm 0.02").

Built-in Ethernet Capabilities (TCP/IP, EtherNet/IP, PROFINET, FTP, SNTIP, Power over Ethernet)

In addition to data, the SR-750 can transfer captured images in real time and quickly check reading status or read error images. Through the use of the standard Ethernet connection, easy integration is possible into most multi-vendor network environments.

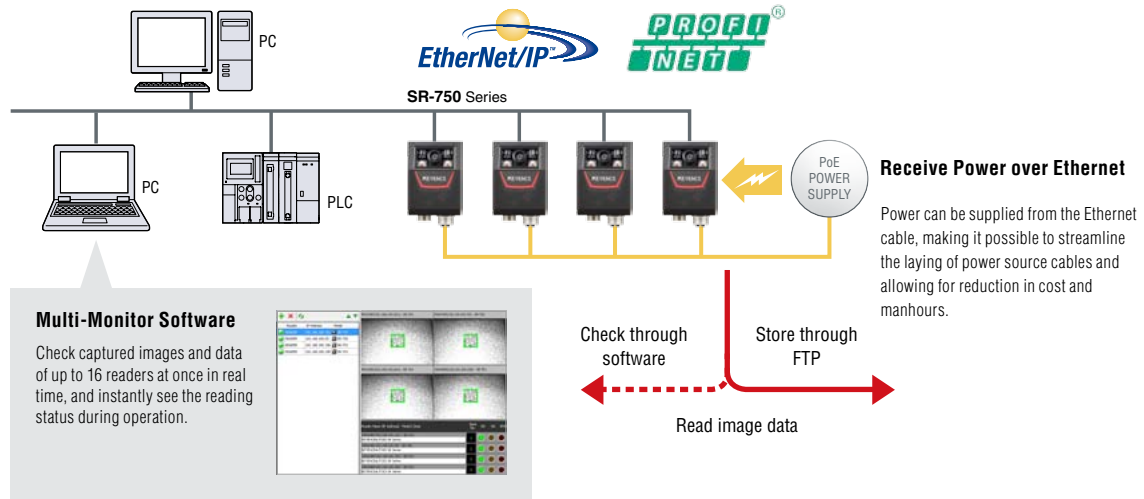

Master/Slave Function for Using Multiple Readers Effectively

This function reduces the programming load on the host computer or PLC drastically when multiple SR-750 readers are used. Two modes are available: multi-drop link mode and multi-head mode.
(Can be used in combination with SR-D100 Series.)

Multi-drop link mode

In this mode, data read by multiple SR-750 Series readers (up to 32) working in different locations are sent collectively by a single master to the host. This eliminates the need for the host to control communication among multiple readers, simplifying programs in the system.

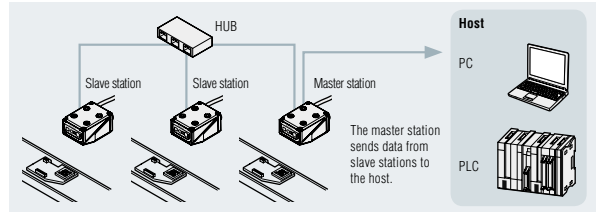

Multi-head mode

This mode allows multiple SR-750 Series readers (up to 8) to operate as a single device. A single trigger can be sent to the master reader, and master reader will output data to the host when the position of the code will change on the part.

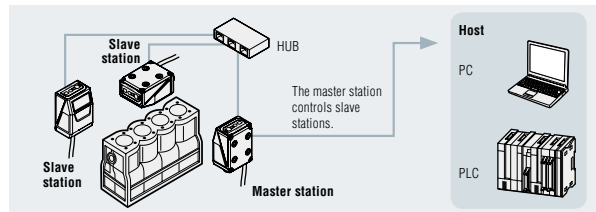

Powerful on Fast Moving Workpieces

Burst Read Function: Acquires up to 8 consecutive images. The decoding process is performed after continuous imaging, allowing for higher speed code detection.

High Speed Image Capturing: The built-in ultra-high-intensity LED, bright enough even during short exposure times, and high-speed digital signal processor (DSP) can capture moving objects effectively. (Read codes at line speed up to 170 m/min 557.7 ft./min with a KEYENCE test label)

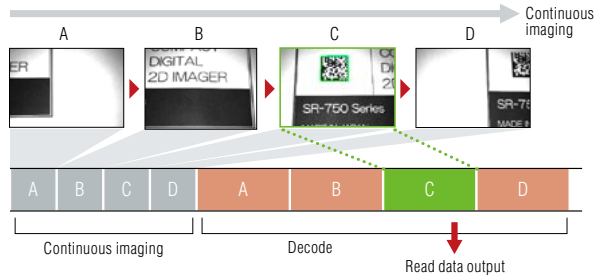

Automatic Selection of Optimal Reading Conditions (Parameter Bank Function)

Even if difficult codes are mixed with ordinary codes on the same line, the SR-750 Series will automatically alternate between registered parameters until the proper reading conditions are found.

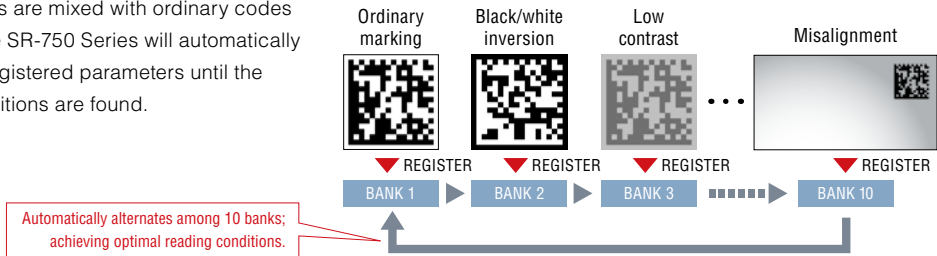

NEW

Data Edit Function

Output data and FTP image file names can be edited, leading to reduction in data processing on the host. Output only required character strings or configure readers as drop-in replacement on existing systems with reduced programming.



PRODUCT LINEUP

MAIN UNIT



High-resolution type
SR-750HA



Close-range type
SR-750



Middle-range type
SR-751



Long-range type
SR-752

LENS ATTACHMENT



400 mm **15.75"** lens: **SR-75L4**
600 mm **23.62"** lens: **SR-75L6**

CABLE



NFPA79 compliant control cable with D-sub 9-pin
2 m **6.56'**: **OP-87527**
5 m **16.4'**: **OP-87528**
10 m **32.8'**: **OP-87529**



NFPA79 compliant control cable
2 m **6.56'**: **OP-87353**
5 m **16.4'**: **OP-87354**
10 m **32.8'**: **OP-87355**



NFPA79 compliant Ethernet cable
2 m **6.56'**: **OP-87359**
5 m **16.4'**: **OP-87360**
10 m **32.8'**: **OP-87361**

SETTING SOFTWARE



AutoID Network Navigator
SR-H3W

READING RANGE CHARACTERISTICS [TYPICAL]

Unit: mm inch

SR-750HA: High-resolution type

Code type	Cell size Narrow bar width	A	B
DataMatrix QR	0.08 0.003"	31 1.22"	39 1.54"
	0.127 0.005"	27 1.06"	42 1.66"
Code39	0.25 0.010"	22 0.87"	50 1.97"

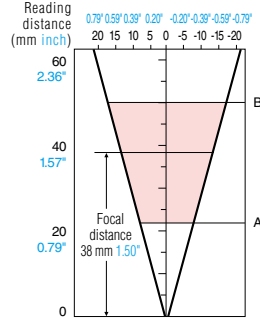

SR-750: Close-range type

Code type	Cell size Narrow bar width	A	B
DataMatrix QR	0.127 0.005"	50 1.97"	70 2.76"
	0.25 0.010"	40 1.57"	80 3.15"
Code39	0.127 0.005"	46 1.81"	74 2.91"
Code128	0.33 0.013"	30 1.18"	100 3.94"
Code128	0.25 0.010"	34 1.34"	90 3.54"

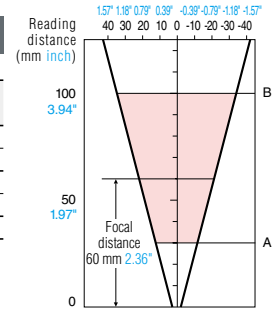

SR-751: Middle-range type

Code type	Cell size Narrow bar width	A	B
DataMatrix QR	0.25 0.010"	65 2.56"	130 5.12"
	0.5 0.02"	45 1.77"	165 6.50"
Code39	0.127 0.005"	75 2.95"	110 4.33"
Code128	0.5 0.02"	45 1.77"	195 7.68"
Code128	0.25 0.010"	50 1.97"	150 5.91"

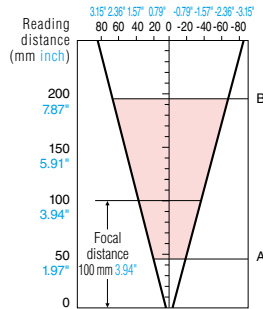

SR-752: Long-range type

Code type	Cell size Narrow bar width	A	B
DataMatrix QR	0.19 0.007"	220 8.66"	260 10.24"
	0.25 0.010"	210 8.27"	270 10.63"
Code39	0.33 0.013"	200 7.87"	280 11.02"
	0.5 0.02"	180 7.09"	305 12.01"
Code128	0.17 0.007"	220 8.66"	260 10.24"
	0.5 0.02"	180 7.09"	330 12.99"
Code128	0.25 0.010"	195 7.68"	275 10.83"

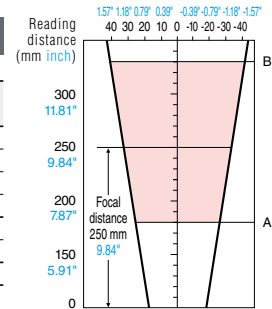

SR-752 + SR-75L4 (400 mm 15.75" lens)

Code type	Cell size Narrow bar width	A	B
DataMatrix QR	0.33 0.013"	350 13.78"	450 17.72"
	0.5 0.02"	300 11.81"	490 19.29"
Code39	0.22 0.009"	370 14.57"	440 17.32"
	0.5 0.02"	250 9.84"	540 21.26"
Code128	0.25 0.010"	350 13.78"	450 17.72"

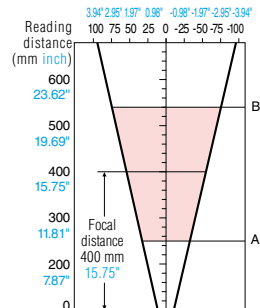

SR-752 + SR-75L6 (600 mm 23.62" lens)

Code type	Cell size Narrow bar width	A	B
DataMatrix QR	0.5 0.02"	460 18.11"	690 27.17"
	1 0.04"	330 12.99"	860 33.86"
Code39	0.33 0.013"	500 19.69"	690 27.17"
	0.5 0.02"	400 15.75"	760 29.92"
Code128	0.33 0.013"	500 19.69"	690 27.17"

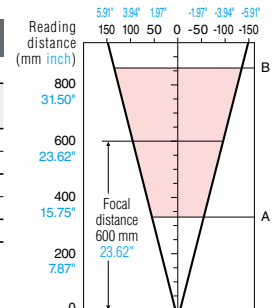

DIMENSIONS

Unit: mm inch

Main unit

SR-750/751/750HA

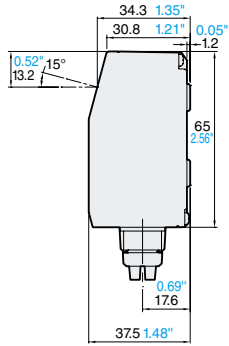

SR-752

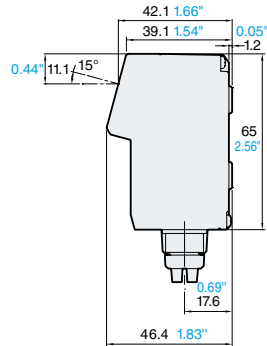

With port cover

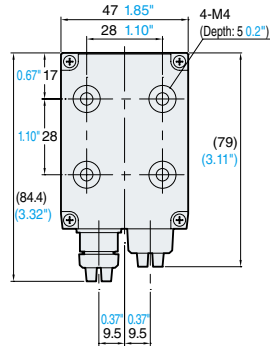

With cable

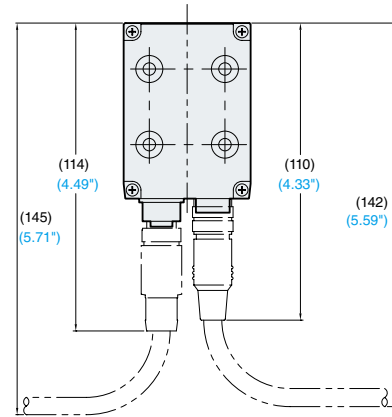

Mounting bracket

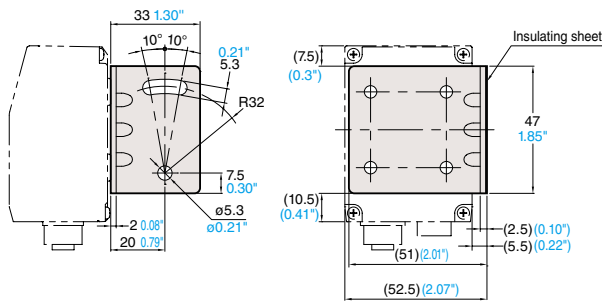

Long distance lens attachment SR-75L4/75L6

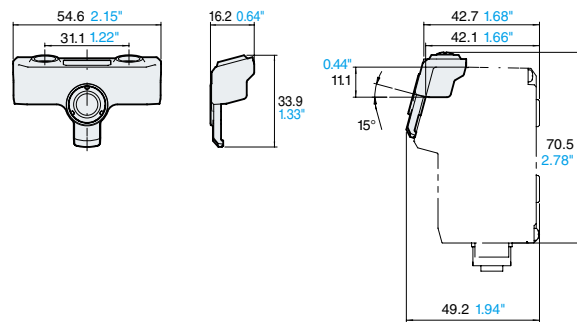

NFPA79 compliant control cable

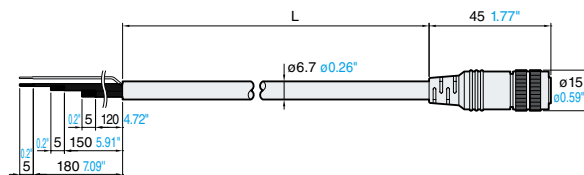

Model	L
OP-87353	2 m 6.56'
OP-87354	5 m 16.4'
OP-87355	10 m 32.8'

NFPA79 compliant Ethernet cable

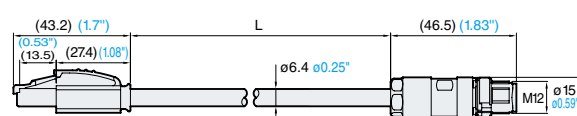

Model	L
OP-87359	2 m 6.56'
OP-87360	5 m 16.4'
OP-87361	10 m 32.8'

Ethernet plug assembly

OP-87362

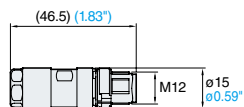

SPECIFICATIONS (MAIN UNIT)



Model		SR-750HA	SR-750	SR-751	SR-752	SR-752 + SR-75L4	SR-752 + SR-75L6	
Type		High-resolution type	Close-range type	Middle-range type	Long-range type	With 400 mm 15.75" lens	With 600 mm 23.62" lens	
Receiver	Sensor	CMOS Image Sensor						
	Number of pixels	752 x 480 pixels						
Lighting	Light source	Red LED						
Laser pointer	Light source	Visible semiconductor laser, Wavelength 660 nm						
	Output	60 μW						
	Pulse duration	200 μs						
	Laser class	Class 1 Laser Product (IEC60825-1, FDA (CDRH) Part 1040.10**)						
Reading specifications	Supported symbol	QR, MicroQR, DataMatrix (ECC200), GS1 DataMatrix						
	Barcode	GS1 DataBar, CODE39, CODE39 FullASCII, ITF, NW-7 (Codabar), CODE128, GS1-128, JAN/EAN/UPC						
	Minimum resolution	2D	0.082 mm 0.003*	0.127 mm 0.005*	0.19 mm 0.007*	0.19 mm 0.007*	0.33 mm 0.013*	0.5 mm 0.02*
		Barcode	-	0.127 mm 0.005*	0.127 mm 0.005*	0.17 mm 0.007*	0.22 mm 0.009*	0.33 mm 0.013*
	Reading distance (typical examples)	DataMatrix QR	22 to 50 mm 0.87" to 1.97" (Cell size = 0.25 mm 0.01")	40 to 80 mm 1.58" to 3.15" (Cell size = 0.25 mm 0.01")	45 to 165 mm 1.77" to 6.50" (Cell size = 0.5 mm 0.02")	180 to 305 mm 7.09" to 12.01" (Cell size = 0.5 mm 0.02")	300 to 490 mm 11.81" to 19.29" (Cell size = 0.5 mm 0.02")	460 to 690 mm 18.11" to 27.17" (Cell size = 0.5 mm 0.02")
		Barcode	-	30 to 100 mm 1.18" to 3.94" (Narrow bar width = 0.33 mm 0.013")	45 to 195 mm 1.77" to 7.68" (Narrow bar width = 0.5 mm 0.02")	180 to 330 mm 7.09" to 12.99" (Narrow bar width = 0.5 mm 0.02")	250 to 540 mm 9.84" to 21.26" (Narrow bar width = 0.5 mm 0.02")	400 to 760 mm 15.75" to 29.92" (Narrow bar width = 0.5 mm 0.02")
	Focal distance	38 mm 1.50*	60 mm 2.36*	100 mm 3.94*	250 mm 9.84*	400 mm 15.75*	600 mm 23.62*	
	Field of view (at focal distance)	26.6 x 17.0 mm 1.05" x 0.67"	42.5 x 27.1 mm 1.67" x 1.07"	70.6 x 45.0 mm 2.78" x 1.77"	65.0 x 41.5 mm 2.56" x 1.63"	108 x 69 mm 4.25" x 2.72"	165 x 106 mm 6.50" x 4.17"	
I/O specifications	Control input	Number of inputs	2					
		Input type	Bidirectional voltage input					
		Maximum rating	26.4 VDC					
		Minimum ON voltage	15 VDC					
	Control output	Maximum OFF current	0.2 mA or less					
		Number of outputs	3					
		Output type	Photo MOS relay output					
		Maximum rating	30 VDC					
		Maximum load current	1 output: 50 mA or less, Total of 3 outputs: 100 mA or less					
		Leakage current when OFF	0.1 mA or less					
	Ethernet	Residual voltage when ON	1 V or less					
		Communication standard	10BASE-T/100BASE-TX					
		Supported protocol	TCP/IP, FTP, SNT, BOOTP, EtherNet/IP, PROFINET, MC protocol, KV STUDIO					
	Serial communication	Communication standard	RS-232C compliant					
Transmission speed		9600, 19200, 38400, 57600, 115200 bps						
Supported protocol		Non-procedural, MC protocol, SYSDAY, KV STUDIO						
Environmental resistance	Enclosure rating	IP65						
	Ambient temperature	0 to 45°C 32 to 113 °F						
	Ambient storage temperature	-10 to +50°C 14 to 122 °F						
	Relative humidity	35 to 95% RH (No condensation)						
	Storage ambient humidity	35 to 95% RH (No condensation)						
	Ambient luminance	Sunlight: 10000 lux, Incandescent lamp: 6000 lux, Fluorescent lamp: 2000 lux						
	Operating environment	No dust or corrosive gas present						
Rating	Vibration	10 to 55 Hz Double amplitude 1.5 mm 0.06"/55 to 500 Hz: Acceleration 5G, 3 hours each in X, Y and Z directions						
	Power voltage**3	Control port: 24 VDC±10% or Ethernet port: PoE TypeA/B 36 to 57 V (Cannot supply at the same time)						
Weight	Current consumption	Control port: 220 mA (When 24 VDC power supply is used) Ethernet port: PoE Power Class 2**						
		Approx. 160 g			Approx. 175 g		Approx. 185 g	

*1 SR-750HA can read Barcodes which fit into the Field of View.
 *2 The laser classification for FDA (CDRH) is implemented based on IEC60825-1 in accordance with the requirements of Laser Notice No.50.
 *3 To comply with CSA No.61010-1/UL61010-1/IEC61010-1, use a power supply meeting the following criteria:
 - provides Class 2 output as defined in the CEC and NEC, or
 - evaluated as a Limited Power Source as defined in CAN/CSA-C22.2 No.60950-1/UL60950-1/IEC60950-1.
 *4 Peak operating current for PoE Power Class 2: 210 mA maximum.
 * PROFINET is a trademark or registered trademark of PROFIBUS International.
 * EtherNet/IP is a trademark or registered trademark of ODVA.

SPECIFICATIONS (SETTING SOFTWARE)

Model	SR-H3W
Supported OS	Microsoft Windows XP (SP3 or later) Microsoft Windows Vista Business/Ultimate SP2 or later Microsoft Windows 7 Professional or later Microsoft Windows 8 (* Except for Windows RT)
Running environment*	• RAM: System memory 1 GB or more (2 GB or more for 64 bit OS) • HDD: 512 MB or more of free space

* .NET Framework 3.5 SP1 or above is required



CALL TOLL FREE TO CONTACT YOUR LOCAL OFFICE
1-888-KEYENCE
 1 - 8 8 8 - 5 3 9 - 3 6 2 3

www.keyence.com

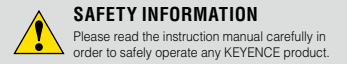

KEYENCE CORPORATION OF AMERICA

Corporate Office 669 River Drive, Suite 403, Elmwood Park, NJ 07407 PHONE: 888-539-3623 FAX: 855-539-0123 E-mail: keyence@keyence.com
Sales & Marketing Head Office 1100 North Arlington Heights Road, Suite 210, Itasca, IL 60143 PHONE: 888-539-3623 FAX: 855-539-0123

Regional offices
AL Birmingham **CO** Denver **IN** Indianapolis **MI** Detroit **NJ** Elmwood Park **OH** Cincinnati **SC** Greenville **TX** Dallas
CA N. California **FL** Tampa **KS** Kansas City **MI** Grand Rapids **NY** Rochester **OH** Cleveland **TN** Knoxville **VA** Richmond
CA Los Angeles **GA** Atlanta **KY** Louisville **MN** Minneapolis **NC** Charlotte **OR** Portland **TN** Nashville **WA** Seattle
IL Chicago **MA** Boston **MO** St. Louis **NC** Raleigh **PA** Philadelphia **TX** Austin **WI** Milwaukee

KEYENCE CANADA INC.

Head Office PHONE: 905-366-7655 FAX: 905-366-1122 E-mail: keyencecanada@keyence.com
Montreal PHONE: 514-694-4740 FAX: 514-694-3206

KEYENCE MEXICO S.A. DE C.V.

PHONE: +52-81-8220-7900 FAX: +52-81-8220-9097
 E-mail: keyencemexico@keyence.com

KEYENCE CORPORATION

1-3-14, Higashi-Nakajima, Higashi-Yodogawa-ku, Osaka, 533-8555, Japan PHONE: +81-6-6379-2211

