

General characteristics

A modular range of devices for domestic and similar use which can be installed in surface- or flush-mounting boxes and in ordinary and watertight boxes. The System range for domestic use has a modular structure on flush-mounting frames up to 12 modules. Surface-mounting and free-standing boxes and plates are included, along with watertight plates (IP55) and outdoor containers (IP40 and IP55).

The range includes controls, socket-outlets, protections, indicators, connectors and special components with high quality characteristics.

TECHNICAL DATA AND REFERENCE STANDARDS							
Component	Reference standards	Essential electrical data*			Prolonged operation (no. position changes)	Resistance to abnormal heat and fire	
		Resistance at test voltage (V)	Insulation resistance (MΩ)	Breaking capacity or category of use		Thermo-pressure with ball (°C)	Glow Wire Test (°C)
Commands	EN 60669-1	2000 at 50 Hz for 1 minute	> 5	1.25 In (200 position changes)	40,000 at In 250V AC cos φ = 0.6	125	850
Socket-outlets	IEC 60884-1			1.25 In (100 position changes)	10,000 at In 250V AC cos φ = 0.8		
Latching relays	EN 60669-1 / EN 60669-2-2			1.25 In (200 position changes)	50,000 at In 250V AC cos φ = 0.6		
Momentary relays	EN 60669-1 / EN 60669-2-2						
Miniature circuit breakers	EN 60898-1		2** ÷ 5	3KA	8,000		
Residual current circuit breakers	EN 61009-1 / EN 61008-1			3KA	4,000		
Supports and plates	EN 60669-1	-	-	-	-	70	650

* For rated voltages and currents, see the specifications in the single codes. ** The value of 2 MΩ refers to a special condition established by the standards given alongside.

BEHAVIOUR WITH CHEMICAL AND ATMOSPHERIC AGENTS													
Component	Agent	Water	Saline solution	Acids		Bases		Solvents			Mineral oil	UV rays	
				Concentrated	Diluted	Concentrated	Diluted	Hexane	Benzol	Acetone			Ethyl alcohol
Plates		Resistant	Resistant	Limited resistance	Resistant	Resistant	Resistant	Limited resistance	Not resistant	Not resistant	Not resistant	Limited resistance	Resistant
SYSTEM devices		Resistant	Limited resistance	Not resistant	Limited resistance	Limited resistance	Resistant	Resistant	Resistant	Resistant	Resistant	Resistant	Resistant

* The resistance values given are valid for an ambient temperature no higher than 40°C.

Terminal resistance to cable traction: > 50N

Device hold on support: > 0.6J

TERMINAL TIGHTENING CAPACITY			
Stranded wires		Solid wires	
Minimum	Maximum	Minimum	Maximum
0.75mm ²	2 x 4mm ²	0.5mm ²	2 x 2.5mm ²

Common construction features

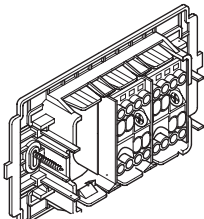

Quick installation: fixing the devices on the supports from both front or rear.

Simplicity of connections: double terminals, cable clamp with unlosable screws and protection collars.

SYMBOL DISCS

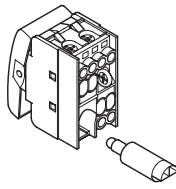

Miniature lamps

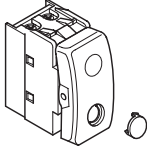

Symbol discs for functional signalling

For technical information contact the Technical Assistance Service or visit gewiss.com

Degree of protection of the set of SYSTEM domestic range assembly installed

COMPONENT	INSTALLATION	REFERENCE STANDARD	IP RATING
Devices with closed front (commands, bells, indicators, etc.) installed in flush-mounting boxes, surface-mounting boxes, free-standing panels (completed with support and plate) and in self-supporting boxes	Flush-mounting for domestic or similar finish, in vertical position, installed to a high standard	EN60529	41
Devices with open front (socket-outlets, etc.) installed in flush-mounting boxes, surface-mounting boxes, free-standing panels (completed with support and plate) and in self-supporting boxes	Flush-mounting for domestic or similar finish, in vertical position, installed to a high standard. Suitable for use for zone 3 of rooms containing baths or showers.		X1 (it is 21 in case of socket-outlets)
Devices with open front (socket-outlets, etc.) installed in flush-mounting boxes, surface-mounting boxes, free-standing panels (completed with support and plate) and in self-supporting boxes	Flush-mounting for domestic or similar finish, in vertical position, installed to a high standard with plug inserted		4X

ACCESSORIES

Spare parts and accessories

Lamps for System articles

CONTROL DEVICES			MINIATURE LAMP UNITS				Luminous / colour RESULT	OBTAINABLE COLOURS		
Functional	Functional localisation	Iconographic signalling	Type	Code	Voltage	Colour	The signalling colour corresponds to the colour of the chosen miniature lamp	White Light blue Red Green		
			LED	GW 10 893	12-24V AC/DC	White				
				GW 30 947	230/110V AC					
			Fluorescent	GW 30 946	230/110V AC	Light blue				
				GW 30 943	230V AC	Red				
				GW 30 944	230V AC	Green				
PUSH-BUTTON WITH NAME PLATE			CARTRIDGE LAMPS				Luminous / colour RESULT	OBTAINABLE COLOURS		
			Type	Code	Voltage	Colour	White backlighting	White		
			Incandescent S6 x 36	GW 20 902	12V AC/DC	White				
							GW 20 903	24V AC/DC		
			SINGLE INDICATOR LAMPS			CARTRIDGE LAMPS				Luminous / colour RESULT
			Type	Code	Voltage	Colour	The signalling colour corresponds to the colour of the chosen indicator lamp diffuser	Red - Green Amber - White Light blue		
			Incandescent S6 x 31	GW 20 904	12V AC/DC	White				
				GW 20 905	24V AC/DC					
			Fluorescent S6.3 x 28	GW 20 906	230V AC	Red			With red diffuser:	Red
				GW 20 908		Green			With amber diffuser:	Amber
					Green	With green diffuser:	Green			
			STAIR RISER LAMPS			CARTRIDGE LAMPS				Luminous / colour RESULT
			Type	Code	Voltage	Colour	The signalling colour corresponds to the colour of the chosen stair riser lamp diffuser	Red - Green Amber - White Light blue		
			Incandescent S6 x 36	GW 20 902	12V AC/DC	White				
							GW 20 903	24V AC/DC		

Examples of functional and localisation lighting

To indicate the operating status of services not visible from the command position

The indicator lamp is located parallel to the service, and is switched on when the one-way switch is ON. The indicator lamp follows the ON/OFF status of the service.

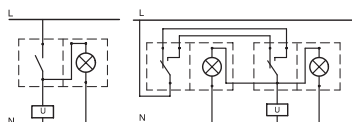

The two indicator lamps and the service are placed in parallel, therefore they switch on and off together with the service

To locate the command button key in the dark

The indicator lamp is switched on when the one-way switch is OFF. With the one-way switch in the ON position, the service is powered and the indicator lamp is switched off.

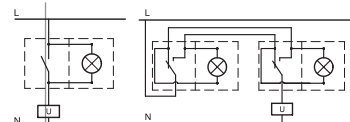

The two indicator lamps come on when the service is not powered and go off when it is ON.

NOTE: layouts not suitable for commanding compact energy saving lamps, LED lamps and/or relays

COMMAND

Infrared movement detector

The passive infrared movement detector senses temperature variations within its range of action and, depending on the environmental light, closes a relay contact. When movement stops, the contact automatically opens again after an adjustable set time. The device incorporates a light-sensitive sensor with an adjustable tripping threshold to avoid controlling the service (e.g. lighting equipment) when not necessary.

Reference standards: EN 60669-1; EN 60669-2-1

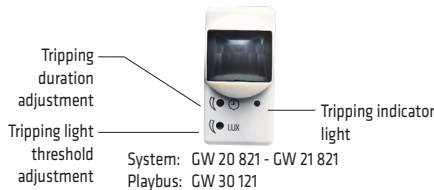

Connection diagram

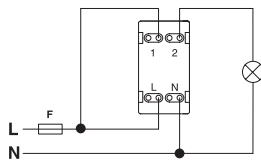

DATI TECNICI	
Power supply voltage	230V - 50/60Hz
Light-sensitive threshold setting	10 lux - max. inhibited
Activation duration setting	15 sec / 10 min
Output contact	1 NA 3A (AC1) 250V ac, potential-free
Type of load:	
Resistive loads	700W
Incandescent lamps	450W
Low voltage halogen lamps (12V)	450W
Uncompensated fluorescent lamps	2x58W
Motor and motor reduction units	400VA
Operating temperature	-5 / + 40 °C
Relative humidity	max. 93% non condensative

Not suitable for compensated fluorescent lamps, for discharge lamps and for those loads not indicated; please use an auxiliary relay to control such lamps.

Applications

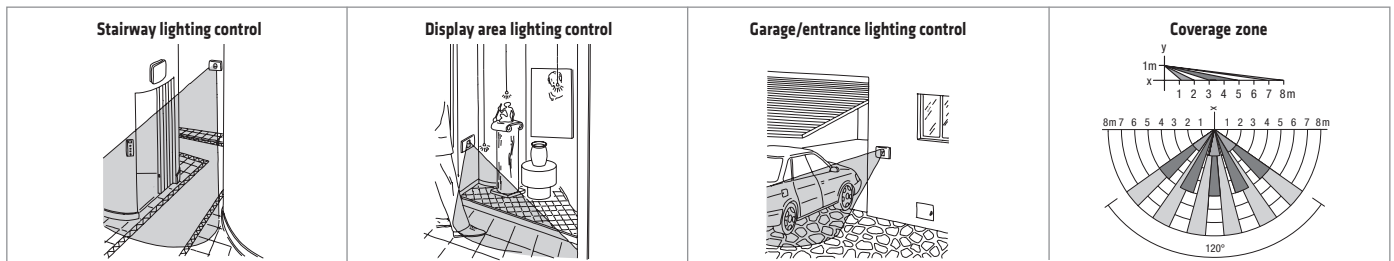

Relay

Latching relay

Latching-type relay for controlling lamps from several points using push-buttons with NO contact.

Momentary relay

For executing automatic mechanisms or separations between the control circuit and the power circuit. Can be used as an auxiliary element for controlling particular loads.

LATCHING RELAY			MOMENTARY RELAY		
Reference standards: EN 60669-1; EN 60669-2-2		System: GW 20 071 GW 21 071 GW 20 072 GW 21 072 Playbus: GW 30 111	Reference standards: EN 60669-1; EN 60669-2-2		System: GW 20 074 GW 21 074 Playbus: GW 30 116

TECHNICAL DATA

Power supply voltage (coil)	230V - 50/60Hz	Power supply voltage (coil)	230V - 50/60Hz
Output contact	GW 20 071 / 21 071 / 30 111 1NO; GW 20 072 / 21 072 / 2NO 10A (AC1) / 7A (AC15) - 250V AC	Output contact	1 changeover contact NO/NC; 10A (AC1) / 4A (AC15) - 250V AC

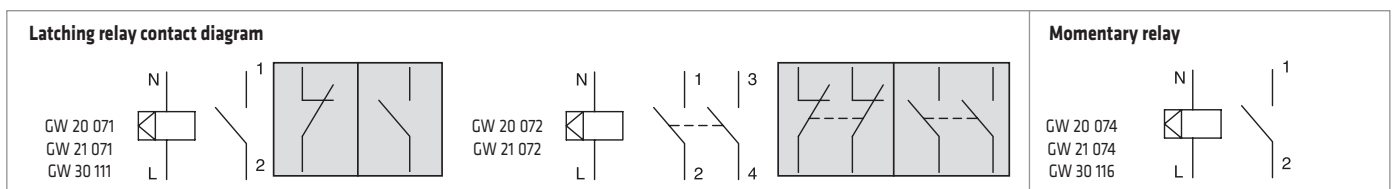

For technical information contact the Technical Assistance Service or visit gewiss.com

Call relay

“Bathroom Alarm” call system

For the locations where it is compulsory (bathrooms), space must be allowed for the manoeuvring of a wheel chair, and an emergency bell must be fitted near the toilet and bathtub.

Connection diagram

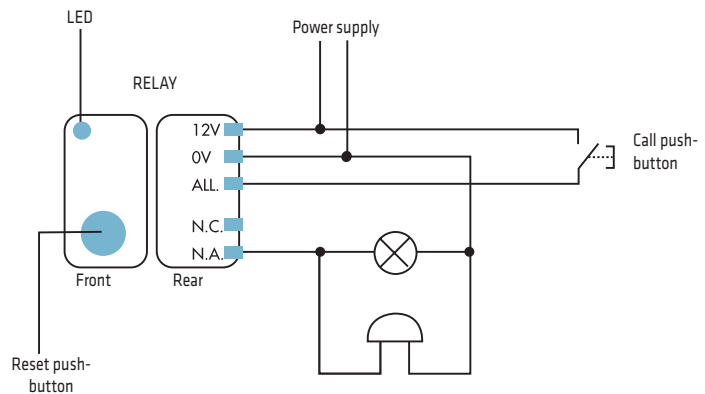

Multiple call system

For small concerns (school classrooms, clinics, nursing homes, etc.) where the call must be localised from the control station.

KEY	12V power supply:	230V power supply:
	■ +	■ L
	■ -	■ N

Connection diagram

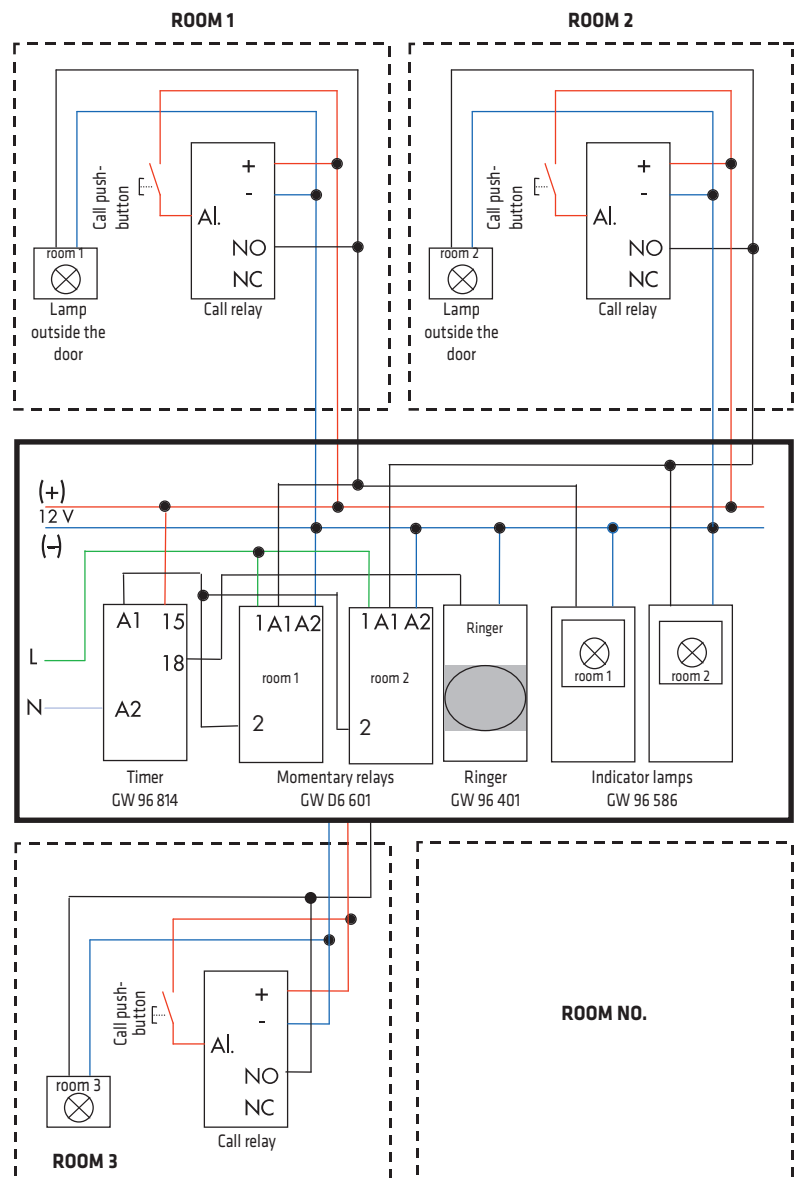

Call display board located in the control station.

CALL RELAY	
Reference standards: EN 60669-1; EN 60669-2-2	GW 20 076 GW 21 076
TECHNICAL DATA	
Power supply voltage (coil)	12V AC / 12V DC
Output contact	1NO/NC 12V

For technical information contact the Technical Assistance Service or visit gewiss.com

SIGNAL



TV-SAT socket-outlets

The development of television transmission systems and of services intended for the user has raised the performance and quality level required for signal distribution systems.

The EN 60728 standards (systems for distribution of television and sound signals via cable) define the present and future European Standard and establish the requisites that the various parts of the system (including the terminal socket-outlets) must meet.

Thanks to their high performance level, these new socket-outlets provide optimal distribution of the signals (both digital and analogue), as required by the various providers for accessing current and future services.

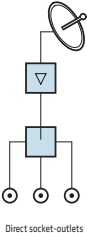
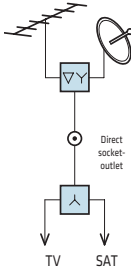
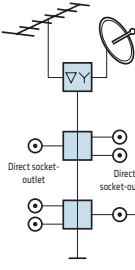
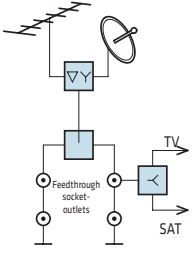
	CHARACTERISTICS	ADVANTAGES
	<ul style="list-style-type: none"> Shielding efficiency (in compliance with standard EN 60728-4). 	<ul style="list-style-type: none"> The socket-outlets are in a metal shell and are unaffected by the electromagnetic emissions (EMC) present in the environment.
	<ul style="list-style-type: none"> Impedance adaptation. An innovative system for the quick, safe connection of the coaxial cable. 	<ul style="list-style-type: none"> Undesired signal reflections are avoided. Maintains the co-axiality of the cable in the connection point.
	<ul style="list-style-type: none"> A range featuring two types: user ports with F connector (type EN 60169-24) and with male IEC connector Ø 9.5mm (in compliance with HD 134.2 S2). 	<ul style="list-style-type: none"> Maximum application flexibility with single or centralised systems (new / restored / pre-arrangements for future extensions). In satellite reception, due to the frequency range, it is very important to maintain the co-axiality of the connection, which is a requirement fully met by the innovative connection and the use of the F connector.

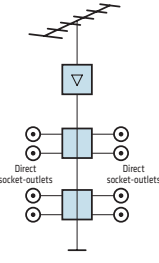
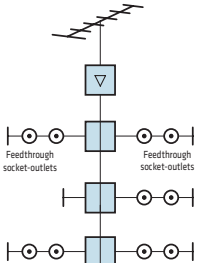
APPLICATIONS	TV		SAT	TV-SAT		
	Centralised system with star distribution	Centralised system with cascade distribution	SAT system for single service	Combined TV-SAT system for single service	Combined TV-SAT centralised system with star distribution	Combined TV-SAT centralised system with feedthrough socket-outlets
 System: GW 20 391 GW 21 391 GW 20 396 GW 21 396 GW 20 392 GW 21 392 GW 20 393 GW 21 393 Playbus: GW 30 311 GW 30 316 GW 30 312			 Direct socket-outlets	 Direct socket-outlet TV SAT	 Direct socket-outlet Direct socket-outlet TV SAT	 Feedthrough socket-outlets TV SAT
 System: GW 20 381 GW 21 381 GW 20 386 GW 21 386 GW 20 382 GW 21 382 GW 20 383 GW 21 383 System: GW 21 381 GW 21 386 GW 21 382 GW 21 383 Playbus: GW 30 301 GW 30 306 GW 30 302	 Direct socket-outlets Direct socket-outlets	 Feedthrough socket-outlets Feedthrough socket-outlets				

Reference standards: EN 50083-1; EN 50083-2; EN 50083-4

Resistance of terminal closure: 75 ohm



GW 20 277

TECHNICAL DATA

Frequency field	From 5 to 2400 MHz
Diameter of the coaxial cable	From Ø 5 to Ø 7mm
Return channel	From 5 to 40 MHz
Shielding	Class A
Chrominance/luminance delay difference	< 1 ns. for all models
TV port	male IEC coaxial connector Ø 9.5mm
SAT port	F (female) coaxial connector

For technical information contact the Technical Assistance Service or visit gewiss.com

TV-SAT socket-outlets attenuation values

Gewiss code	Nominal attenuation (dB)	Attenuation / Loss of passage (flattening of response)				Branching attenuation / Loss of base (flattening of response)				Directivity		Return loss (dB)		
		Return channel	TV	SAT		Return channel	TV	SAT		Return channel	TV-SAT	Return channel	TV-SAT	
		5-40 MHz	47-862 MHz	950-2150 MHz	2150-2400 MHz	5-40 MHz	47-862 MHz	950-2150 MHz	2150-2400 MHz	5-40 MHz	47-2400 MHz	5-40 MHz	47-2400 MHz	
GW 20 391 - GW 20 381 GW 21 391 - GW 21 381 GW 30 311 - GW 30 301	0	-	-	-	-	≤ 0.5 dB (≤ 0.2 dB)	≤ 0.5 dB (≤ 0.5 dB)	≤ 0.8 dB (≤ 0.5 dB)	≤ 0.8 dB (≤ 0.5 dB)	-	-	≥ 10 dB		
GW 20 392 - GW 20 382 GW 21 392 - GW 21 382 GW 30 312 - GW 30 302	10	≤ 2.5 dB (≤ 1 dB)	≤ 2 dB (≤ 1 dB)	≤ 3 dB (≤ 1.5 dB)	≤ 3.2 dB (≤ 1.5 dB)	10.5 dB (± 1.5 dB)	10dB (± 1.5 dB)	10.5 dB (± 1.5 dB)	11dB (± 2.5 dB)	≥ 15 dB	complying with CEI-EN 50083-4	≥ 10 dB	complying with CEI-EN 50083-4	
GW 20 393 - GW 20 383 GW 21 393 - GW 21 383 GW 30 313 - GW 30 303	14	≤ 1.5 dB (≤ 1 dB)	≤ 1.2 dB (≤ 1 dB)	≤ 2.2 dB (≤ 1.5 dB)	≤ 2.5 dB (≤ 1.5 dB)	15 dB (± 1.5 dB)	14.5 dB (± 1.5 dB)	14.5 dB (± 1.5 dB)	15 dB (± 2.5 dB)	≥ 15 dB		≥ 10 dB		
													Insulation / separation between ports	
GW 20 396 - GW 20 386 GW 21 396 - GW 21 386 GW 30 316 - GW 30 306	5	≤ 5 dB (≤ 1.5 dB)	≤ 5 dB (≤ 1.5 dB)	≤ 6 dB (≤ 1.5 dB)	≤ 6.5 dB (≤ 1.5 dB)	≤ 5 dB (≤ 1.5 dB)	≤ 5 dB (≤ 1.5 dB)	≤ 6 dB (≤ 1.5 dB)	≤ 6.5 dB (≤ 1.5 dB)	>12 dB	>10 dB	≥ 10 dB	EN 50083-4 Degree 3	

Telephone connectors

4-contact RJ11 telephone connectors, suitable for connecting the telephone, telefax, and modem.



System: GW 20 251
GW 21 251
Playbus: GW 30 261

Reference standards:
ISO 11801

TECHNICAL DATA	GW 20 251 - GW 21 251 GW 30 261
Connector type	RJ11
No. of contacts	4
Connection	Terminal blocks with screws
Category	3
Transmission speed	up to 16 Mb/s

Diagrams

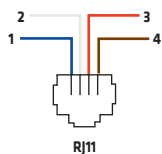

Series connection

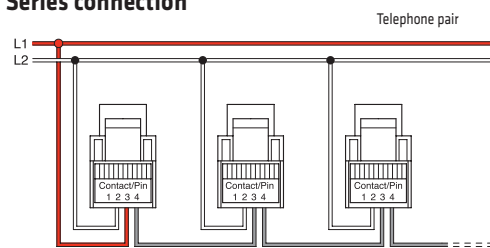

Clamps 3 and 4 are connected by means of the contact inside the telephone, which is closed when the telephone receiver is put down. When the telephone receiver is picked up, the line breaks downstream (L1 pole), ensuring that the conversation is not overheard.

Note: when one of the plugs is extracted, the socket-outlets downstream are disconnected. To prevent this problem, insert a plug with a jumper between terminals 3-4, in the socket-outlet from which the telephone appliance was unplugged.

Parallel connection

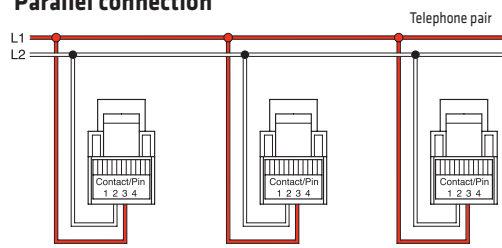

Each socket-outlet takes the signal from the line. There is no conversation secrecy.

For technical information contact the Technical Assistance Service or visit gewiss.com

Connectors for structured wiring

RJ45 connectors in categories 5e and 6, shielded and unshielded for data transmission. They allow network connection of information technology devices (computers, printers, modem, etc.) and the connection of multimedia devices (e.g. those used for video conferences). They can also be used for traditional, centralised telephone systems.

Reference standards: EN 50 173 - ISO 11801 - EIA / TIA 568A

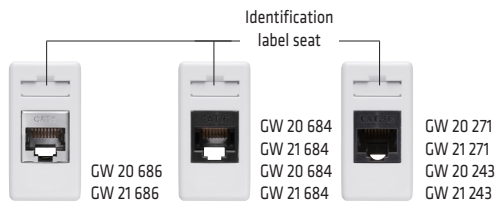

TECHNICAL DATA	GW 20 686 GW 21 686	GW 20 684 - GW 21 684 GW 20 685 - GW 21 685	GW 20 243 GW 21 243	GW 20 271 GW 21 271
Connector type	RJ45			
Type of usable cables	FTP	UTP	FTP	UTP
Number of contacts	8			
Terminals	insulation displacement connection (without the need for tools)			
Category	Cat. 6		Cat. 5e	
Usable transmission protocols	EIA / TIA 568A - EIA / TIA 568B			

Diagrams

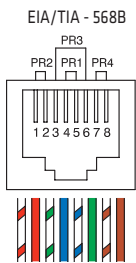
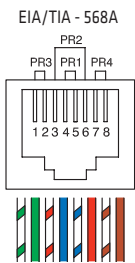

To achieve the EIA/TIA 568A or 568B configuration shown alongside, follow the colour code given on the terminal board (see below).

Quick wiring system

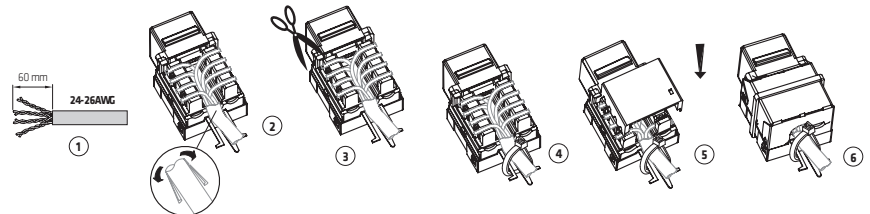

GW 20 243 - GW 21 243
GW 20 686 - GW 21 686

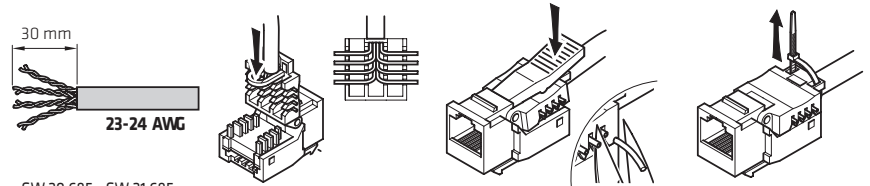

GW 20 685 - GW 21 685

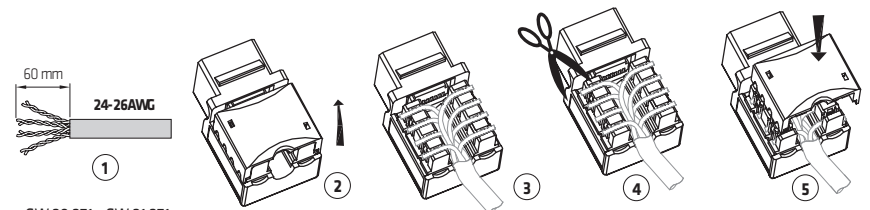

GW 20 271 - GW 21 271
GW 20 684 - GW 21 684

Adapters for structured wiring

A data transmission system with structured wiring offers flexibility of use, installation of the final and universal network, commissioning independent of the location and use of the terminal outputs. In complex and extensive systems (e.g. tenders) the client requires a certificate of conformity for the entire system. Leading companies in the field of structured wiring, installed directly or by qualified operators, are able to provide this service. GEWISS, offering a shell which is compatible with IBM, Systimax/Commscope and AMP/Keystone Jack makes it possible to integrate the PLAYBUS / SYSTEM ranges with data transmission components belonging to a structured system.

USB and HDMI couplers

Female-female couplers with Keystone Jack coupling, for A-type USB and HDMI cables. To complete with GW2x270 adapters.

HDMI coupler



GW 38 056

USB coupler



GW 38 057

USB charger

2.1A double USB charger, suitable for powering mobile phones, smartphones and mobile electronic devices.

Double USB charger



GW 20 361

TECHNICAL DATA

Power supply	100-240V ac - 50/60Hz - 300mA max
Output	5V dc - 2.1A
USB connector	2.0 A-type
Power supply connector	Screw terminals, maximum cable section 1.5 mm ²
Degree of protection	IP20
Operating temperature	0 ÷ +40°C

Suitable to recharge a single 2.1A electronic device or a couple of simultaneous devices. The total current provided (max. 2.1A) is split in the two USB outputs, depending on the state of charge of the connected devices.

PROTECTION

Protection devices

Overvoltage limiter

The overvoltage limiter is a varistor-type discharger suitable for protecting a terminal circuit against mains overvoltages caused by manoeuvres or atmospheric discharges.

Reference standards: EN 61643-11



TECHNICAL DATA	
Rated voltage	250V AC
Maximum discharge current	8 kA (8/20 μs)
Maximum discharge power	75 J

GW 20 423
GW 21 423

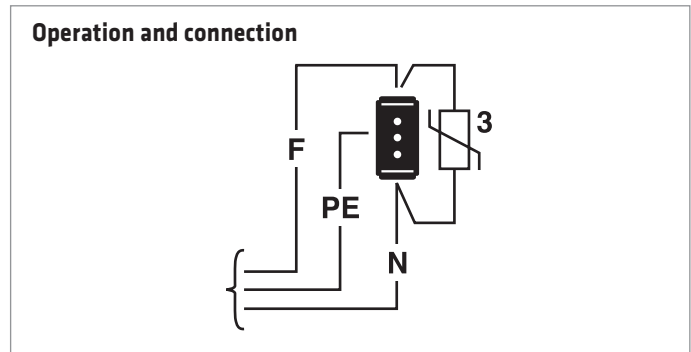

The overvoltage peak is absorbed by the varistor which, for voltage values higher than the arcing value, behaves like a resistor with a very low value. The overvoltage peak will not reach the service or will at least be greatly attenuated. If the varistor breaks, a fuse prevents short-circuiting and the fault is indicated by the LED going out.

Automatic circuit breakers

Automatic miniature circuit breakers for protection against overcurrent and earthing currents of terminal circuits.

Miniature circuit breakers



- System: GW 20 431 GW 21 431
 GW 20 432 GW 21 432
 GW 20 433 GW 21 433
 GW 20 434 GW 21 434
 GW 20 435 GW 21 435
 GW 20 436 GW 21 436
 GW 20 454 (red)
 GW 20 455 (red)
 GW 20 456 (red)
- Playbus: GW 30 371
 GW 30 372
 GW 30 373
 GW 30 374
 GW 30 375
 GW 30 376

Residual current circuit breakers with overcurrent protection



- System: GW 20 437 GW 21 437
 GW 20 438 GW 21 438
 GW 20 439 GW 21 439
 GW 20 448 GW 21 448
 GW 20 449 GW 21 449
 GW 20 450 GW 21 450
- Playbus: GW 30 377
 GW 30 378
 GW 30 379

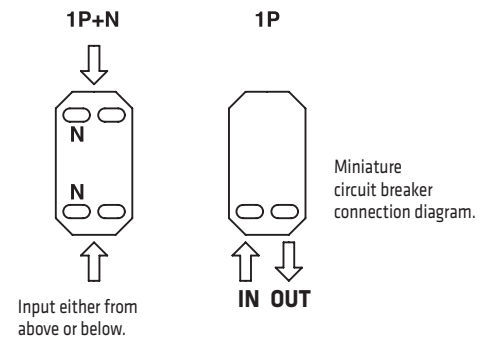

Reference standards: EN 60898 - EN 61009-1 - EN 61543

TECHNICAL DATA									
Type of circuit breakers	Rated voltage (V)	Rated frequency (Hz)	Rated residual current (mA)	Short-circuiting capacity (A)	Range of nominal currents (A)	No. of poles	Tripping characteristic		
							Overcurrent protection	Limiting class	Residual current protection
Miniature circuit breakers	230	50 - 60	-	3000	6 - 10 - 16	1P 1P+N	Type C	3	-
Residual current circuit breakers with overcurrent protection	230	50 - 60	10 - 30	3000	6 - 10 - 16	1P+N	Type C	3	Class A

For technical information contact the Technical Assistance Service or visit gewiss.com

DIMMER

Rotating electronic regulators, for resistive/inductive loads

Dimmer with conventional potentiometer adjustment and static switching off by turning the knob on position zero.

Reference standards: EN 60669-1; EN 60669-2-1

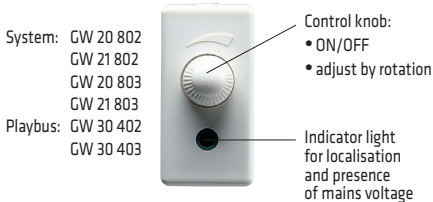

System: GW 20 802
 GW 21 802
 GW 20 803
 GW 21 803
 Playbus: GW 30 402
 GW 30 403

Typical use:

- Domestic sector for light source adjustment.

TECHNICAL DATA	GW 20 802 - GW 21 802 - GW 30 402		GW 20 803 - GW 21 803 - GW 30 403 ()	
Technology	with TRIAC		with TRIAC	
Rated voltage at 50/60Hz	230V	110V	230V	110V
Adjustable power	100-500W	50-250W	100-900W	100-500W
Adjustable load				
- Incandescent and halogen lamps	•	•	•	•
- Toroidal and lamellar transformers			•	•
- Manifold engines			•	•

▲ Items designed solely to export to a limited number of countries outside the European Union or proposed as candidate and to the European Free Trade Association.

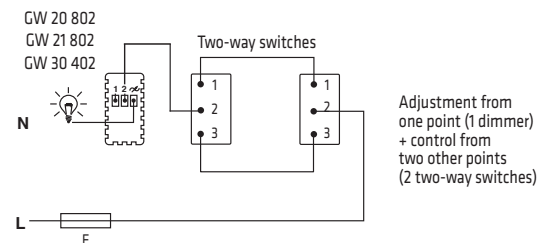
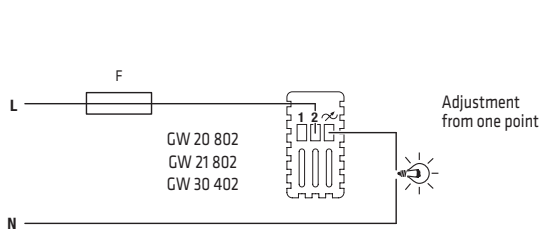

The conformity to EMC Directive is guaranteed only connecting the GW 2x 803 or GW 30 403 regulators to a LC filter as showed in the following wiring diagram.

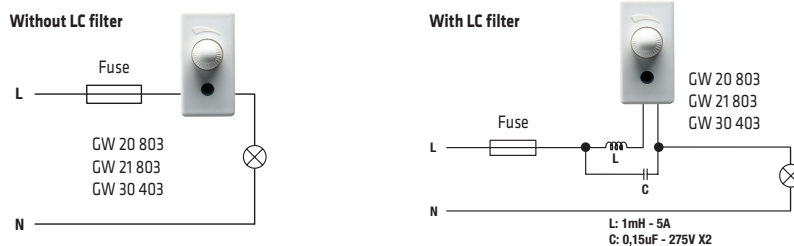

WARNINGS

- The connection should be made together with a fuse carrier (eg. GW 2x 401) with a quick-acting fuse with high breaking capacity type F2.5AH 250Vac (for GW 2x 802 and GW 30 402) or type F5AH 250Vac (for GW 2x 803 and GW 30 403) as shown in the diagrams.
- The regulator does not have a mechanical circuit breaker in the main circuit and so is not galvanically separated. The circuit load should be considered always under voltage.
- The conductors should be pushed down to the bottom of the box. Do not let the conductors in the box contact the walls of the regulator.
- Do not install the regulator near thermostats or chronothermostats.
- Max n.1 regulator in the same round/square box. Max n.2 regulators in the same rectangular box; for installations with 2 regulators in the same box, the maximum loads controllable by each regulator should be reduced by 50%. The side-by-side installation of several products in a single box is not permitted: insert a blanking module between two electronic devices.
- It should be used in dry, dust-free places at a temperature between 0°C and +35°C.

Rotating electronic regulators with two-way switch, for resistive/inductive loads

Dimmer with incorporated two-way switch that makes it possible to command the switching on and off of a second point (using the two-way switch), or a number of points (using intermediate switches). Switched on and off by pressing the knob; adjustment by turning it.

Reference standards: EN 60669-1; EN 60669-2-1

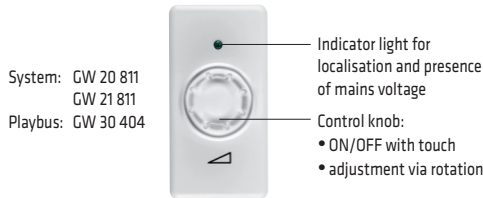

TECHNICAL DATA	GW 20 811 - GW 21 811 - GW 30 404	
Technology	with TRIAC	
Power supply voltage at 50/60Hz	230V	110V
Adjustable power	40÷300W (GW 30 404) 100÷500W (GW 20 811)	20÷150W (GW 30 404)
Adjustable load		
- Incandescent and halogen lamps	•	•
- Toroidal transformers	•	•
- Lamellar transformers	•	•

Typical use:

- Domestic sector for light source adjustment.
- In existing systems, the dimmer with two-way switch can be easily installed in place of a two-way switch, without modifying the original circuit.



WARNINGS

- The connection should be made together with a fuse carrier (eg. GW 2x 401) with a quick-acting fuse with high breaking capacity type F2.5AH 250Vac as shown in the diagrams.
- The conductors should be pushed down to the bottom of the box. Do not let the conductors in the box contact the walls of the regulator.
- Do not install the regulator near thermostats or chronothermostats.
- Max n.1 regulator in the same round/square box. Max n.2 regulators in the same rectangular box; for installations with 2 regulators in the same box, the maximum loads controllable by each regulator should be reduced by 50%. The side-by-side installation of several products in a single box is not permitted: insert a blanking module between two electronic devices.
- It should be used in dry, dust-free places at a temperature between 0°C and +35°C.

Push-button electronic regulators, for air agitators

Push-button type dimmer with pre-set intensity levels (0-25-50-100%). By briefly pressing the push-button, the minimum intensity level will be obtained. With any further touch, the speed will change from the minimum to the medium, then the maximum. A subsequent touch will turn the dimmer off.

Reference standards: EN 60669-1; EN 60669-2-1

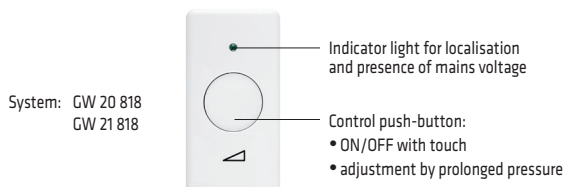

Technical data

Power supply voltage: 230V-50 Hz

Power: 55-80 VA

Typical use:

- Suitable for adjusting air agitators, fans and extractors with induction engines. It can be controlled by external NO push-button.

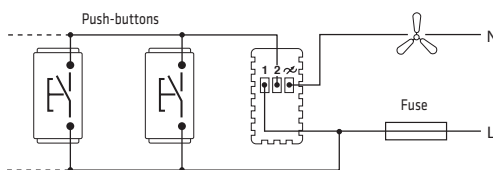

Command and adjustment from several points with NO push-buttons

WARNINGS

- Article only suitable for adjusting air stirrers, fans and aspirators with induction motors with auxiliary phase. Not suitable for adjusting fan-coil motors or light sources.
- The connection should be made together with a fuse carrier (eg. GW 2x 401) with a quick-acting fuse with high breaking capacity type F0.8AH 250Vac as shown in the diagrams.
- The regulator does not have a mechanical circuit breaker in the main circuit and so is not galvanically separated. The circuit load should be considered always under voltage.
- Do not install the regulator near thermostats or chronothermostats.
- It should be used in dry, dust-free places at a temperature between 0°C and +35°C.

For technical information contact the Technical Assistance Service or visit gewiss.com

Push-button electronic regulators, for resistive/inductive loads

Push-button type dimmer, with possibility of control and adjustment from any number of points using single-pole NO push-buttons; gradual switching on and off by briefly touching at the pre-set adjustment level (intensity memory); adjustment with prolonged pressure on the same button. The push-button regulators are available both in traditional and in IGBT technology that allows the regulation of electronic transformers and ensure a quiet and gradual operation.

Reference standards: EN 60669-1; EN 60669-2-1

Control push-button:

- ON/OFF with touch;
- adjustment by prolonged pressure



System: GW 20 828 - GW 21 828
 GW 20 829 - GW 21 829
 Playbus: GW 30 407

TECHNICAL DATA	GW 20 829 - GW 21 829 GW 30 407	GW 20 828 - GW 21 828 GW 30 401
Technology	with IGBT transistor	with TRIAC
Power supply voltage	230V - 50Hz	230V - 50Hz
Adjustable power	25 ÷ 300W (GW 30 406) 40 ÷ 300 (GW 20 829) 25 ÷ 180W (GW 30 407)	60 ÷ 500W
Adjustable load		
- Incandescent and halogen lamps	•	•
- Toroidal transformers	•	•
- Lamellar transformers		•
- Electronic transformers	•	

SPECIFIC FUNCTIONAL CHARACTERISTICS OF THE DIMMER GW 20 829 - GW 21 829 - GW 30 407 WITH IGBT TECHNOLOGY

CHARACTERISTICS	ADVANTAGES
• Possibility of commanding electronic power supplies and reduced loads.	• Versatile use.
• Memorisation of the adjustment level.	• Easy positioning to a standard adjustment.
• Indicator lamp for level of adjustment and protection tripping.	• The indicator lamp allows the device to be identified in the dark; it flashes to show the electronic protection has tripped.
• Automatic search for the maximum level of adjustment.	• Maximum comfort in selecting the level of adjustment.
• Electronic self-protection against overloading and short-circuiting, resettable.	• Protection of the regulator in the event of overload connections or a fault with the service device.
• Adjustment with IGBT transistor.	• Total absence of buzzing during operation.

Typical use:

- Domestic sector, for adjusting light sources
- Commercial sector, hotel rooms, places for communities, conference halls, for adjusting light sources
- In existing systems, the push-button dimmers can be installed in place of two-way switches, without modifying the circuit.

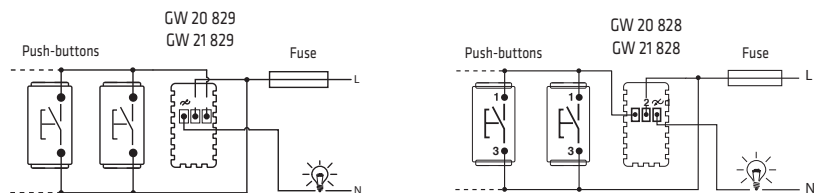

Control and adjustment from several points with NO push-buttons

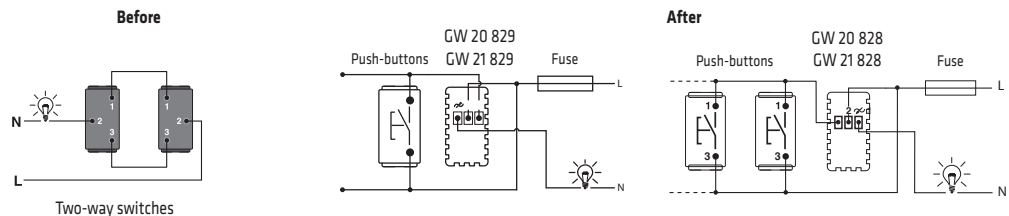

Control from two points (2 two-way switches)

Control and adjustment from two points (1 dimmer + 1 NO push-button)

WARNINGS

- The connection should be made together with a fuse carrier (eg. GW 2x 401) with a quick-acting fuse with high breaking capacity type F2.5AH 250Vac (for GW 2x 828) or type F1.6AH 250Vac (for GW 2x 829) as shown in the diagrams.
- The conductors should be pushed down to the bottom of the box. Do not let the conductors in the box contact the walls of the regulator.
- Do not install the regulator near thermostats or chronothermostats.
- Max n.1 regulator in the same round/square box. Max n.2 regulators in the same rectangular box; for installations with 2 regulators in the same box, the maximum loads controllable by each regulator should be reduced by 50%. The side-by-side installation of several products in a single box is not permitted: insert a blanking module between two electronic devices.
- It should be used in dry, dust-free places at a temperature between 0°C and +35°C.

For technical information contact the Technical Assistance Service or visit gewiss.com

ENERGY AND COMFORT MANAGEMENT

1-channel daily and weekly electronic timer

- Electronic device for the timed command of a load
- Positive LCD display with white backlight
- Permanent indication of: time, day of the week, load lighting status, functioning/working mode status,
- 144 daily cycles that can be set (transitions every 5 minutes)
- Manual activation/deactivation of the load (MAN mode)
- Programmed activation/deactivation of the load (AUTO mode), with daily/weekly cycles
- Permanent deactivation of the load (OFF mode)
- Immediate visualisation of the daily planning, via permanently visualised histogram
- Rechargeable buffer battery

Reference standards: EN 60730-1; EN 60730-2-7



GW 20 825 - GW 21 825

Command push-buttons:

- Selection of functional mode
- Selection of operational mode
- Modify (increase)
- Modify (decrease)

TECHNICAL DATA	
Power supply voltage	230V AC 50/60Hz
Output contacts	1NO/NC 8A(AC1) / 4A(AC15) 250V AC
Reserve charge	48 hours
Dimensions	2 modules
No. activations/deactivations	144

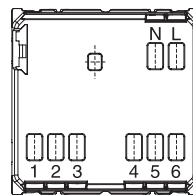

Wiring terminals

- Power supply:** L - Phase
N - Neutral
- Output relay:** 1 - NO contact
2 - NC contact
3 - Common
- Serial line:** 4 - TX (output data)
5 - GND (common)
6 - RX (input data)

Timed electronic push-button

Timer with multiple functions, equipped with push-button for local control allowing the automatic delayed switch-off of lamps, fans, extractors, etc.

Reference standards: EN 60669-1; EN 60669-2-3

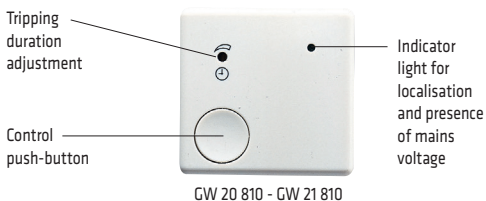

GW 20 810 - GW 21 810

Connection diagrams

Domestic and commercial sectors:

- Stairs, halls and entrance lights (diagram 1 and 2).
- Aspirator for windowless bathrooms (diagram 3 and 4).

TECHNICAL DATA	
Power supply voltage	230V - 50/60Hz
Output contacts (relays)	1NO, 10A (AC1) / 5A (AC15) - 250V AC
Tripping duration adjustment	30s / 15 min.

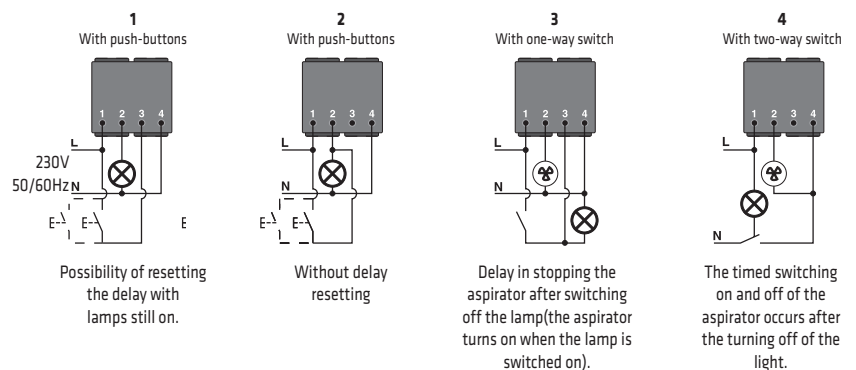

For technical information contact the Technical Assistance Service or visit gewiss.com

CLIMATE CONTROL

Timed thermostat - daily/weekly programming

The timed thermostat allows you to automatically control the weekly temperature and timing within the place of installation, together with the heating and air-conditioning systems.

- Powered by mains voltage
- Relay output contact for commanding the boiler, air-conditioner, zone solenoid valve, etc.
- LCD display with white backlight (the backlighting is activated every time one of the button-keys is pressed, and switches off 5 seconds after the last touch)
- Programming on a weekly basis (a programme for 7 days with hourly profiles independently configurable for each day)
- Setting of hourly profile on 24-hour basis, with 3 different temperature levels (T1, T2, T3) and profile display
- Programming of times with a resolution of 15 minutes without a limit in the number of daily changes
- Residual current circuit breaker for adjustment can be set and differentiated for HEATING and AIR-CONDITIONING
- PARTY and HOLIDAY functions for programming special functioning speeds of different duration periods
- Functioning modes that can be set: AUTOMATIC / MANUAL / OFF
- Possibility to select the system thermal gradient self-learning function. This function optimises the heating anticipation (up to 2 hours) in order to guarantee the set temperature right from program start;
- Rechargeable buffer battery.

Reference standards: EN 60730-1; EN 60730-2-7, EN 60730-2-9

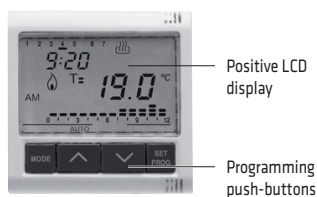

System: GW 20 827 - GW 21 827
Playbus: GW 30 706

TECHNICAL DATA	
Power supply voltage	230V AC 50/60Hz
Dimensions	2 modules
Output contact	1NO/NC with potential-free contact 5A(AC1) / 2A(AC15) 250V AC
Operating temperature	-5 to +45°C
Detected temperature display range	0 to +45°C
Adjustment range	+5 to +40°C
Tolerance	±0.5°C to 20°C
Reserve charge	48 hours

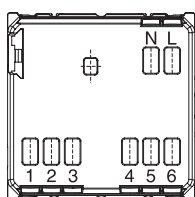

Wiring terminals

- Power supply:** L - Phase
N - Neutral
- Output relay:** 1 - NO contact
2 - NC contact
3 - Common
- Serial line:** 4 - TX
5 - GND (common)
6 - RX

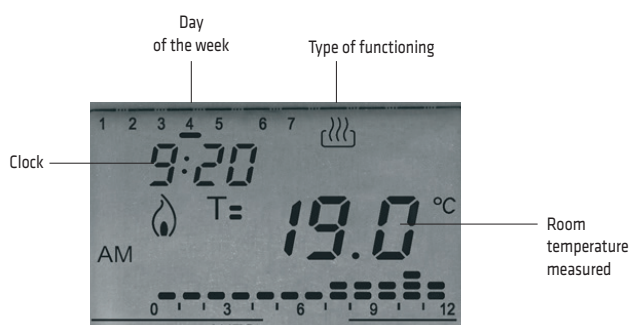

Wall-mounting timed thermostat - daily/weekly programming - battery-powered

The timed thermostat allows you to automatically control the weekly temperature and timing within the place of installation, together with the heating and air-conditioning systems.

- Powered with 3 alkaline batteries (1.5V AAA)
- Relay output contact for commanding the boiler, air-conditioner, zone solenoid valve, etc.
- Programming on a weekly basis (a programme with hourly profiles independently configurable for each day of the week)
- Setting of hourly profile on 24-hour basis, with 3 different temperature levels (T1, T2, T3) and profile display
- Programming of times with a resolution of 15 minutes without a limit in the number of daily changes
- Residual current circuit breaker for adjustment can be set and differentiated for HEATING and COOLING
- PARTY and HOLIDAY functions for programming special functioning speeds of different duration periods
- Functioning modes that can be set: AUTOMATIC / MANUAL / OFF
- Possibility to select the system thermal gradient self-learning function. This function optimises the heating anticipation (up to 2 hours) in order to guarantee the set temperature right from program start;

The device can be wall-mounted (fixed with plugs) or installed on a 3-module flush-mounting box.

Reference standards: EN 60730-1; EN 60730-2-7, EN 60730-2-9



GW 10 701 - GW 14 701

TECHNICAL DATA	
Power supply	3 alkaline-type batteries (1.5V AAA)
Average battery life:	minimum 1 year
Dimensions	130 x 92 x 23mm
Output contact	1NO/NC with potential-free contact 5A(AC1) / 2A(AC15) 250V AC
Operating temperature	-5 to +45°C
Detected temperature display range	0 to +45°C
Adjustment range	+5 to +40°C
Tolerance	± 0.5°C to 20°C

Base for fixing on wall with terminal block

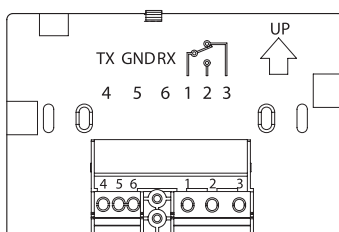

Wiring terminals

Potential-free output:
1 - Common
2 - NO contact
3 - NC contact

Serial line:
4 - TX
5 - GND (common)
6 - RX

For technical information contact the Technical Assistance Service or visit gewiss.com

Temperature control devices

Electronic summer/winter thermometer with knob adjustment

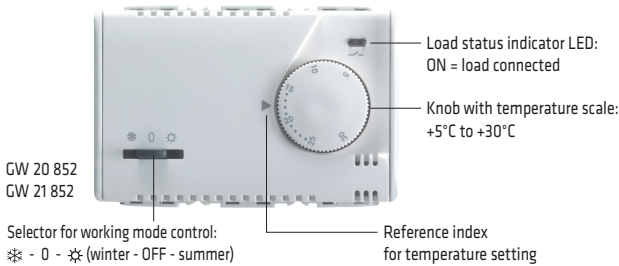

GW 20 852
GW 21 852

Reference standards: EN 60730-1;EN 60730-2-9

TECHNICAL DATA	
Power supply voltage	230V AC - 50/60Hz
Type of output	relay, with changeover contact NO/NC 8(2)A / 250V AC
Service connections (load)	2 or 3 wires
Indicator lights	LED indicating load connected/disconnected
Night-time reduction control	possibility of remote application, suitable for "Winter" operation
Reduction temperature (referred to set temperature)	-4°C
Adjustment range	from +5°C to +30°C
Hysteresis	$\Delta t = 0.7^\circ\text{C}$
Reading accuracy	$\pm 1^\circ\text{C}$
Operating temperature limits	0°C to +50°C

Installation characteristics

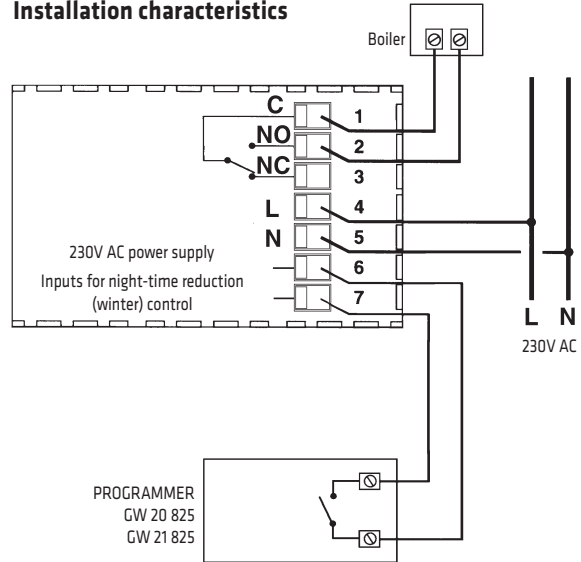

Example of connection to boiler and clock for night-time reduction control

Electronic thermostat for fan coil

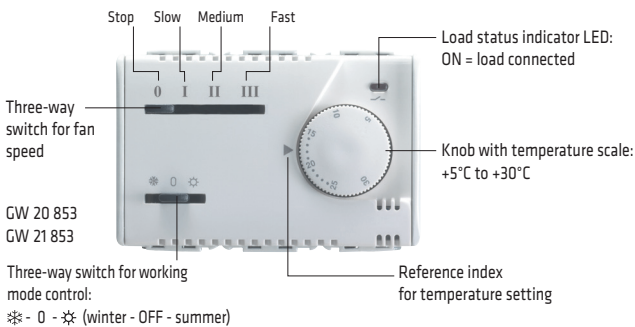

GW 20 853
GW 21 853

Reference standards: EN 60730-1;EN 60730-2-9

TECHNICAL DATA	
Power supply voltage	230V AC - 50/60Hz
Type of output for type of control	
- fixed fan	polarised single-pole three-way switch 5(2)A / 250V AC
- solenoid valve (thermostat-controlled):	polarised single-pole ON/OFF relay 5(2)A / 250V AC
- fan + solenoid valve (thermostat-controlled):	relay + three-way switch, max. total capacity 5(2)A / 250V AC
Indicator lights	LED indicating load connected/disconnected
Adjustment range	from +5°C to +30°C
Reading accuracy	$\pm 1^\circ\text{C}$
Operating temperature limits	0°C to +50°C

Installation characteristics

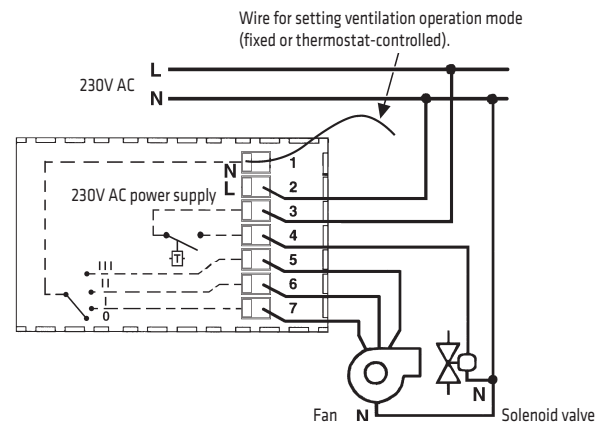

- Depending on the type of installation, connect the speed control wires from the fan to terminals **5 - 6 - 7**:
 - terminal no. **5** - fan "Fast"
 - terminal no. **6** - fan "Medium"
 - terminal no. **7** - fan "Slow"
- The solenoid valve command is always thermostat-controlled.
- To change the ventilation setting, follow the instructions below:
 - a) - Thermostat-controlled ventilation** - Connect the wire emerging above the thermostat terminal block (hole 1) to terminal no. **4**
 - b) - Fixed ventilation** - Connect the wire emerging above the thermostat terminal block (hole 1) to terminal no. **3**.
- The thermostat is factory-set for operation with thermostat-controlled ventilation.

SIGNALLING

Anti-blackout lamp

Flush-mounting anti-blackout lamp

Flush-mounting anti-blackout lamp, 1 System module, suitable for auxiliary lighting in the event of a mains failure. Front LED indicating presence of mains and standby (steady green light).



GW 20 835 - GW 21 835

TECHNICAL DATA	
Power supply voltage	230V AC
Battery	Ni-Mh (2 elements from 2.4V)
Minimum autonomy	1 hour
Recharging time	12 hours
Lamp	White high efficiency LED
Mains absorption	Max 6.5mA
Dimensions	1 System module

Extractable anti black-out lamp

Extractable lamp suitable as auxiliary lighting in the event of mains failure, with possibility to be used as flashlight. The lamp can be switched off via the frontal switch.



System: GW 20 833 - GW 21 833
Playbus: GW 30 501

TECHNICAL DATA	
Power supply voltage	230V - 50/60Hz
Batteries	Ni-Mh (4.8V / 40mAh)
Minimum autonomy	2h
Recharging time	36 hours
Lamp	White high efficiency LED
Mains absorption	Max 6 mA
Dimensions	2 System modules

Electronic ringer with 3 different sounds

Acoustic signaller with multiple functions, suitable for producing three clearly distinguished signals, e.g. bathroom alarm (emergency type sound), main entrance bell (two-tone sound), secondary entrance bell (ringing sound).

Possibility of ringer volume adjustment (using a small tool) with a selector located on the front of the product.



Volume adjustment selector

GW 20 641 - GW 21 641
GW 20 643 - GW 21 643

TECHNICAL DATA	
Power supply voltage	GW 20 641 - GW 21 641 12V 50Hz
	GW 20 643 - GW 21 643 230V 50Hz
Sound intensity	GW 20 641 - GW 21 641 90dB at 1m
	GW 20 643 - GW 21 643 90dB at 1m
Max. power absorbed	GW 20 641 - GW 21 641 3 VA
	GW 20 643 - GW 21 643 3 VA

Application examples

bathroom alarm bell
terminal 1 (emergency)

main entrance bell
terminal 2 (two-tone)

secondary entrance bell
terminal 3 (ring)

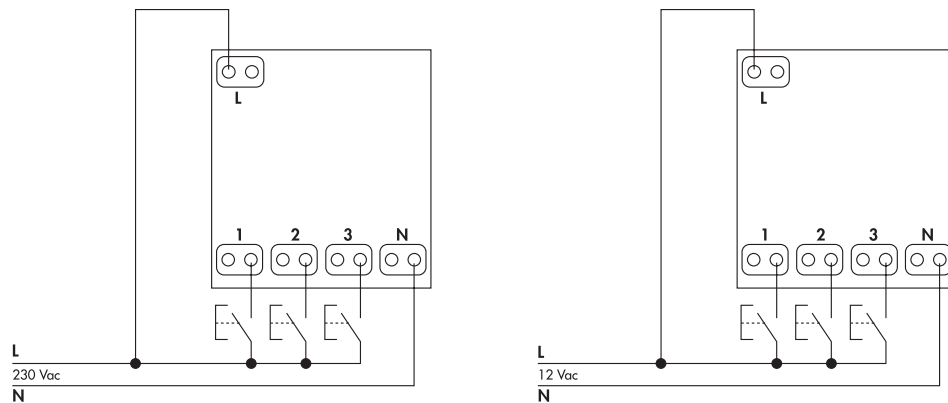

Stair riser lamp with white LED 12-230V AC

The product has a dual power supply input (12 - 230V AC), a light beam adjuster device, and an integrated white LED.

Reference standards: EN 62094-1



GW 20 634
GW 21 634

TECHNICAL DATA	
Power supply voltage	12/230V AC double input
Type of lamp	Bright white LED
Draw	12V 0.12 W/0.12 VA
	230V 0.6 W/3.6 VA

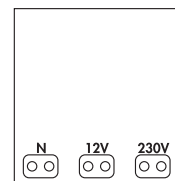

SAFETY

Gas detectors

The gas detectors reveal the presence of substances (CH₄/GPL) that are dangerous for the domestic environment where they are installed

- Indicator lights and acoustic alarm signalling
- Closure of a solenoid valve, via relay
- Indicator lights for malfunctioning of sensor or device
- Device operating test function

The closure of the solenoid valve via the relay is carried out approximately 20s after the start of the alarm situation.

The push-button allows you to carry out the operational test: when pressed, the red LED lights up (alarm signalling), the buzzer sounds and, after about 20s, the relay is activated. Upon the release of the push-button, the signalling is immediately deactivated.

The detectors can be powered through the 12V power supply unit GW10720.

Owing to the particular thermal sensitivity of the LPG sensor, you are advised to position it far from the power supply unit, and apply a blanking module.

Reference standards: EN 50081-1; EN 50082-1

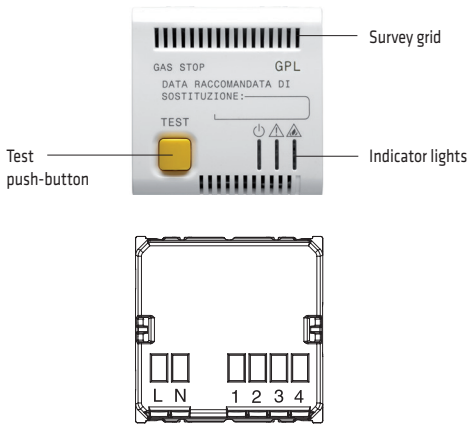

LPG
System: GW 20 868 - GW 21 868
Playbus: GW 30 520

METHANE GAS
System: GW 20 867 - GW 21 867
Playbus: GW 30 519

Connection terminals

- L - N - 12V AC/DC power supply
- 1 - Common
- 2 - NC contact
- 3 - NO contact
- 4 - NO contact

TECHNICAL DATA	
Power supply voltage	12V AC/DC
Power absorbed	2 VA
Alarm threshold	9% LIE (lower explosive limit)
Alarm sound level	85 dB at 1m
Operating temperature	+5 to +40°C
Relative environmental humidity	+30 to +90% without condensation
Output contact in switching:	1 NO/NC 10A (NO)/3A (NC) 250V AC
Fixing	flush-mounting on CHORUS support
Dimensions	2 modules
Lifespan of device	5 years from when first powered

Connection diagram

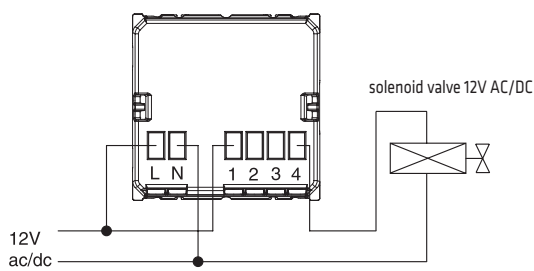

Correct positioning of detectors

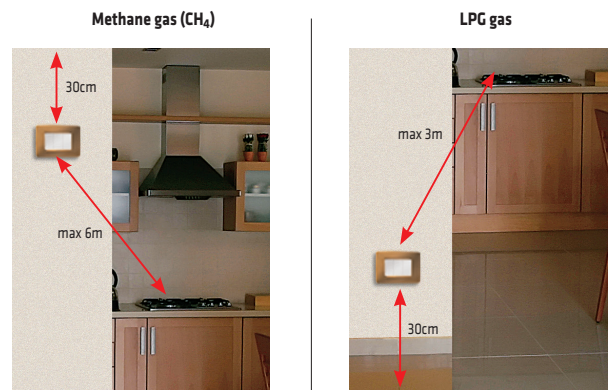

12Vdc power supply unit

Insulation transformer suitable for the power supply of gas (methane and LPG) detectors. Internally protected against overloading, short-circuiting and excessively high temperatures.



GW 10 720

Wiring terminals

Power supply:
L - Phase
N - Neutral

12V output:
+12V - Positive
-12V - Negative

TECHNICAL DATA	
Power supply voltage	110/240Vac - 50/60Hz - 150mA
Output voltage	12V dc - 300mA
Dimensions (mm)	52x33x17

For technical information contact the Technical Assistance Service or visit gewiss.com

HOTEL COMPONENTS

"Do not disturb" and "Make up the room" command and light signalling

Inside the hotel room is located a 3-way switch with printed the symbols "Do not disturb" and "Make up the room". It is used to inform the service staff, thanks to an external double indicator lamp unit, the customer's will not to be disturbed or to clean the room.



Three-way switch 1P - 10AX
DND + MUR
GW 20 651



230V indicator lamp unit
DND + MUR
GW 20 656

The indicator lamp unit is supplied with 230V LED lamps (red for DND signalling, green for MUR signalling)

Application example

