

# MCR-PSP

## MCR Threshold Value Switch, Programmable

### 1. Short description

- continuous measured value display
- four independently adjustable switching thresholds
- with or without galvanic isolation of input signals
- can be programmed using MCR-PI-CONF-WIN software

The MCR-PSP modules are used for the monitoring and regulation of processes. Four switching thresholds that can be adjusted independently of one another react to the signals of various thermocouple sensors, resistance thermometers and linear resistors that can be connected directly. An input for analog standard signals is provided to monitor process signals that have already been converted.

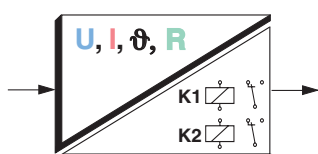

Fig. 1

The module can either be programmed using the MCR-PI-CONF-WIN software (see page 15) or the membrane keypad. The device can be adapted to a variety of applications using the keypad at the front and the display. The LED display constantly displays the current measured value so that the process value can also be monitored visually.

The two relays are designed as PDT contacts with adjustable time delay, and the limit values of each contact have a modifiable hysteresis. This option gives you the advantage of being able to set four switching thresholds independently of one another. In order to provide additional diagnostics the relays can be connected to pick up or drop out during a failure mode in auxiliary voltage to the module. In case of linebreak or short circuit each of the relays can be set to pick up or drop out by software or membrane keypad. In the default setting both relays are set to pick up.

The devices with isolated inputs decouple the field level and auxiliary power, thus avoiding the creation of distributed measurement circuits.

The housings are 45 mm wide and connected with pluggable screw connections (COMBICON) and can be mounted on commercially available EN mounting rails.

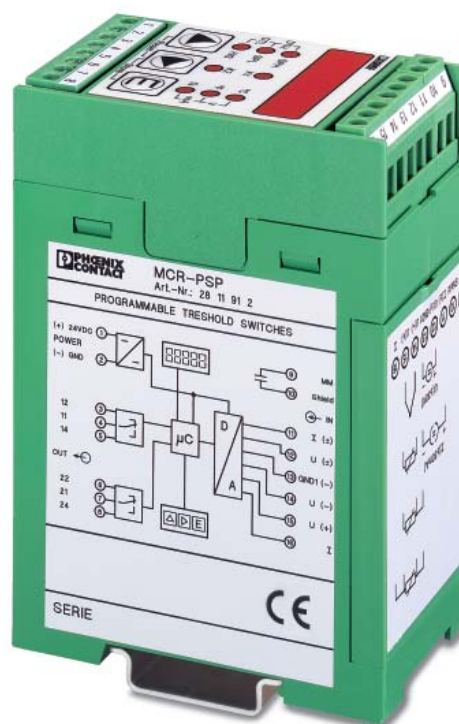

Fig. 2



Fig. 3

# MCR Threshold Value Switch, Programmable - MCR-PSP

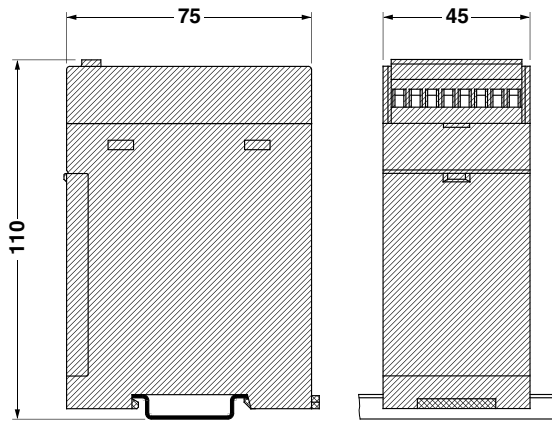

Fig. 4



Fig. 5

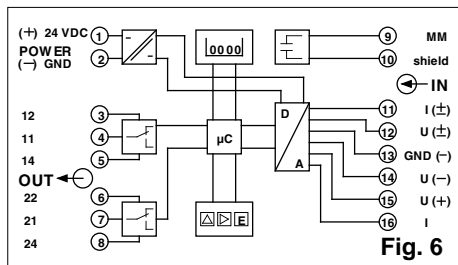

Fig. 6

## MCR-PSP

with signal input: Standard signals  
Temperature sensors

(UL planned)

(IEC) [mm <sup>2</sup> ]	rigid solid	flexible stranded	AWG
Connection data	0.2-2.5	0.2-2.5	24-14

## 2. Description

MCR threshold value switch,  
with dual setpoint relay contacts  
also with galvanically isolated input

### 2.1. Technical Data

#### Input

Input signal:

- resistance thermometer 2, 3 or 4-wire configuration (acc. to DIN 43 760/DIN IEC 751 or SAMA RC 21-4-1966)
- resistance
- thermocouple sensors (acc. to DIN IEC 584-1/DIN 43 710)
- current
- voltage

Input resistance:

- current
- voltage

Setting accuracy

Input protection

Display

Keys

Type	Order No.	Pcs. Pkt.
MCR-PSP	28 11 91 2	1
MCR-PSP-DC	28 11 92 5	1

(see also 2.4. Additional information input, page 4)  
e.g. PT100, Ni etc.

0...8 kΩ (only 2-wire connection)

B, E, J, K, L, N, R, S, T, U

- 30 mA ... + 30 mA

- 30 V...+ 30 V

50 Ω

200 kΩ

0.1 °C / 0.01 V / 0.01 mA / 0.1 Ω

transient protection, resistant to overload up to 30 V DC

Red 7-segment LED indicator, 5-digit, for displaying measured values and setting inputs, switching points etc. Eight red LEDs for displaying the unit of measured value and in edit mode, for displaying the value set.

Display frequency: 2 Hz

for RTD 3 and RTD 4 1.5 Hz

3 membrane buttons for setting the various parameters

# MCR Threshold Value Switch, Programmable - MCR-PSP

Output Relay level	2 x PDT contacts / 2 switching points each low/high (settable)
Switching output 1 (K 1) Switching point 1, lower limit (SPL) Switching point 1, upper limit (SPH)	1 x Um (AgNiO 0.15 + HTV hard gold-plated) 250 V AC, 2 A min. input value ... max. input value – double switching tolerance min. input value + double switching tolerance ... max. input value
Switching output 2 (K 2) Switching point 2, lower limit (SPL) Switching point 2, upper limit (SPH)	1 x Um (AgNiO 0.15 + HTV hard gold-plated) 250 V AC, 2 A min. input value ... max. input value- double switching tolerance min. input value + double switching tolerance ... max. input value
Cycles Setting accuracy Tolerance/Hysteresis around the switching point	30 x 10 <sup>6</sup> 0.1 °C/0.1 °F/0.1 Ω/0.01 V/0.01 mA Depending on the type of sensor set (see 2.5. switching tolerance of different inputs, page 11)
Delay time high/low of the relay	0.0 ... 1.0 secs, can be set in 0.1 sec. steps 1.0 ... 2.0 secs, can be set in 0.2 sec. steps

## 2.2. General Data

Supply voltage	20 ... 30 V DC
Current consumption	< 60 mA
Temperature coefficient	≤ 0.01 %/K
Test voltage: auxiliary power supply/input	1 kV, 50 Hz, 1 min.
Protection circuit	transient protection, polarity protection
Ambient temperature range	-20 °C to + 65 °C
Display resolution	0.1 °C/ 0.01 V/0.01 mA/0.1 Ω
Offset error (Zero)	typ. < 0.05% F.S.
Gain error (Span)	typ. < 0.05% F.S.
Linearity error	typ. < 0.05K (only for RTD and THC)
Total error	typ. < 0.1% F.S.
Type of connection:	
• Input	screw terminal block
• Output and supply	pluggable screw terminal block
Installed position / mounting	any
Standards and regulations	IEC 664/IEC 664 A/DIN VDE 0110-1:1989-01

### Type of housing

**ABS,** see Online catalog  
color: green

**Torque value of terminal screws, see Online catalog.**

**Marking systems and mounting material, see Online catalog.**

**The rated cross section (see Online catalog) refers to untreated conductors without ferrules.**

## 2.3. (EMC) electromagnetic compatibility



**Complies with EMC guideline 89/336/EEC and low voltage directive 73/23/EEC**

Immunity to interference in acc. with EN 50082-2

• Electrostatic discharge (ESD)	EN 61000-4-2	Criterion B 8 kV discharge in air
• Electromagnetic HF field: Amplitude modulation Pulse modulation	EN 61000-4-3	Criterion A 10 V/m 10 V/m
• Fast transients (Burst)	EN 61000-4-4	Criterion B I/O/S: 2 kV/5 kHz <b>1)</b>
• Surge voltage capacities (Surge)	EN 61000-4-5	Criterion B I/O: 2 kV/42 Ω <b>1)</b>
• Conducted disturbance	EN 61000-4-6	Criterion A I/O/S: 10 V <b>1)</b>
• Noise emission in acc. with EN50081-2	EN 55011	Class A

EN 61000 corresponds to IEC 1000

EN 55011 corresponds to CISPR11

**1) I ≙ Input / O ≙ Output / S ≙ Supply**

Criterion A: Normal operating behavior within the defined limits.

Criterion B: Temporary impairment of operational behavior that the device corrects itself.

Class A: Area of application: industry, without special installation measures.

# MCR Threshold Value Switch, Programmable - MCR-PSP

## 2.4. Additional information, input

<b>Resistance thermometer (RTD sensors)</b>	acc. to IEC 751/EN 60751 or DIN 43760 SAMA RC 21-4-1966 in 2, 3 or 4-conductor circuit		
	<b>Type</b>	<b>Standard</b>	<b>Measuring range</b>
	Pt sensors	( DIN/SAMA )	-200...+850 °C -328...+1562 °F
	Ni sensors	( DIN/SAMA )	-60...+180 °C -76...+356 °F
	Ni 1000	(Landis&Gyr)	-50...+160 °C -58...+320 °F
	Cu 10	( SAMA )	-70...+500 °C -94...+932 °F
	KTY 81-110	( Philips )	-55...+150 °C -67...+302 °F
<b>Thermo-couples (TC)</b>	<b>Type</b>	<b>Standard</b>	<b>Measuring range</b>
	B	IEC584	+500...+1820 °C +932...+3308 °F
	E		-226...+1000 °C -374...+1832 °F
	J		-210...+1200 °C -346...+2192 °F
	K		-200...+1372 °C -328...+2501.6 °F
	N		-200...+1300 °C -328...+2372 °F
	R		-50...+1768 °C -58...+3214.4 °F
	S		
	T		-200...+400 °C -328...+752 °F
	L	DIN 43710	-200...+900 °C -328...+1652 °F
	U		-200...+600 °C -328...+1112 °F
<b>Other inputs</b>	<b>Type</b>		<b>Measuring range</b>
	resistance (R8000)		0...8 kΩ (in 2-conductor circuit)
	voltage (U 30)		-30...+30 V
	current (I 30)		-30...+30 mA
	internal cold junction		-20...+70 °C
	User (default setting R8000)		0...8 kΩ (in 4-conductor circuit)

# MCR Threshold Value Switch, Programmable - MCR-PSP

## 3. Overview of inputs that can be connected

Sensor type	Display	Nominal range	
		lower limit	upper limit
Pt DIN	Pt d	-200 °C/-328 °F	850 °C/1562 °F
Pt SAMA	Pt S		
Ni DIN	ni d	-60 °C/-76 °F	180 °C/356 °F
Ni SAMA	ni S		
Ni 1000 L&G	ni L	-50 °C/-58 °F	160 °C/320 °F
Cu 10 SAMA	cu S	-70 °C/-94 °F	500 °C/932 °F
TC Type J	tC d	-210 °C/-346 °F	1200 °C/2192 °F
TC Type K	tC c.	-200 °C/-328 °F	1372 °C/2501.6 °F
TC Type E	tC E	-226 °C/-374 °F	1000 °C/1832 °F
TC Type R	tC r	-50 °C/-58 °F	1768 °C/3214.4 °F
TC Type S	tC S		
TC Type T	tC t	-200 °C/-328 °F	400 °C/752 °F
TC Type B	tC b	500 °C/932 °F	1820 °C/3308 °F
TC Type N	tC n	-200 °C/-328 °F	1300 °C/2372 °F
TC Type U	tC u		600 °C/1112 °F
TC Type L	tC L		900 °C/1652 °F
R 8000	r 8000	0 Ω	8000 Ω
I 30	i 30	-30 mA	30 mA
U 30	u 30	-30 V	30 V
Cold Junction	c o l d j.	-20 °C/-4 °F	70 °C/158 °F
User *	u S E r	0 Ω	8000 Ω

\* Default setting R 8000 (4-conductor system)

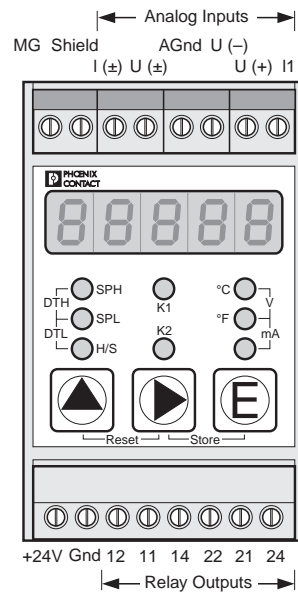

5126A001  
Fig. 7

## 4. Connection Technology

The following is true: The shield of the sensor wire must contact the terminal block shield on the module. It is only connected to the module on one side. The terminal block signal ground must be connected to PE.

### 4.1. Connecting an RTD sensor in 2-conductor technology or a resistor

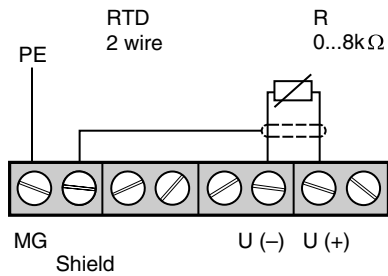

5126A005

**Fig. 8**

### 4.2. Connecting an RTD sensor in 3-conductor technology

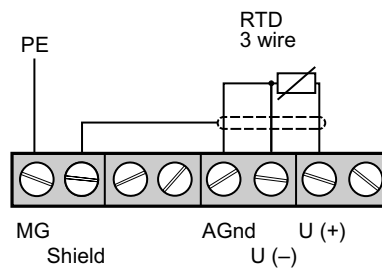

5126A006

**Fig. 9**

### 4.3. Connecting an RTD sensor in 4-conductor technology

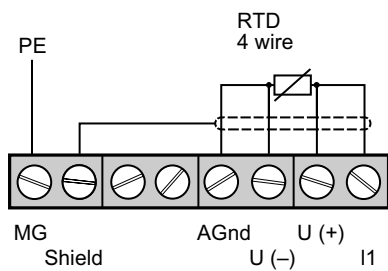

5126A007

**Fig. 10**

### 4.4. Connecting a TC sensor (thermocouple)

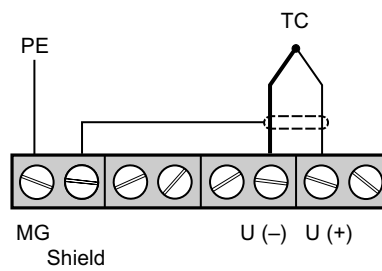

5126A003

**Fig. 11**

### 4.5. Connecting a current signal

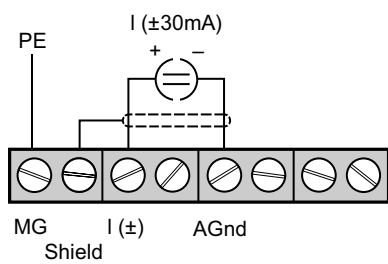

5126A002

**Fig. 12**

### 4.6. Connecting a voltage signal

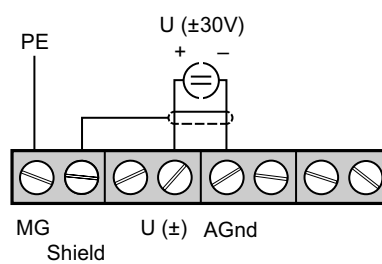

5126A004

**Fig. 13**

# MCR Threshold Value Switch, Programmable - MCR-PSP

## 5. Operating elements

### 5.1. Display



5126A010  
**Fig. 14**

In operating mode, the 5-digit display shows the input value measured and in edit mode, the individual setting options are shown as you “browse” through.

### 5.2. LEDs

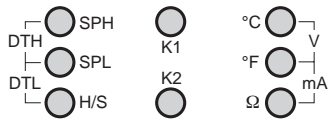

5126A011  
**Fig. 16**

In operating mode, the three right-hand LEDs display the unit of the input value:

- °C: degrees Celsius
- °F: degrees Fahrenheit
- Ω: Ohm
- °C and °F at the same time (V): Volt
- °F and Ω at the same time (mA): milliamperes

The two LEDs in the center and the three to the left light up in edit mode and show which value is currently being set:

- K1: The setting refers to relay 1
- K2: The setting refers to relay 2
- SPH: Set Point High; setting of upper switching point of K1/K2
- SPL: Set Point Low; setting of lower switching point of K1/K2
- H/S: Hysteresis/Switching points; setting of switching behavior of K1/K2
- SPH and SPL at the same time (DTH): Delay Time High; setting of delay time high of K1/K2
- SPL and H/S at the same time (DTL): Delay Time Low; setting of delay time low of K1/K2

### 5.3. Keys

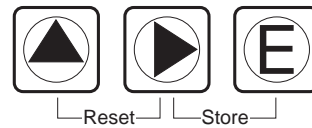

5126A012  
**Fig. 15**

▲ ▲ ▲	Switching to edit mode. The three keys must be pressed directly one after another as the module returns to operating mode with measured value display after a pause of over 2 seconds.
▲ or ▶	Selecting the different settings.
E:	Acknowledge setting and continue to next value.
▲ and ▶ simultaneously:	Reset; cancels edit mode and returns to operating mode.
▶ and E simultaneously:	Store; saves the values set and returns to operating mode.

# MCR Threshold Value Switch, Programmable - MCR-PSP

## 6. Setting parameters

### 6.1. Overview of the menu

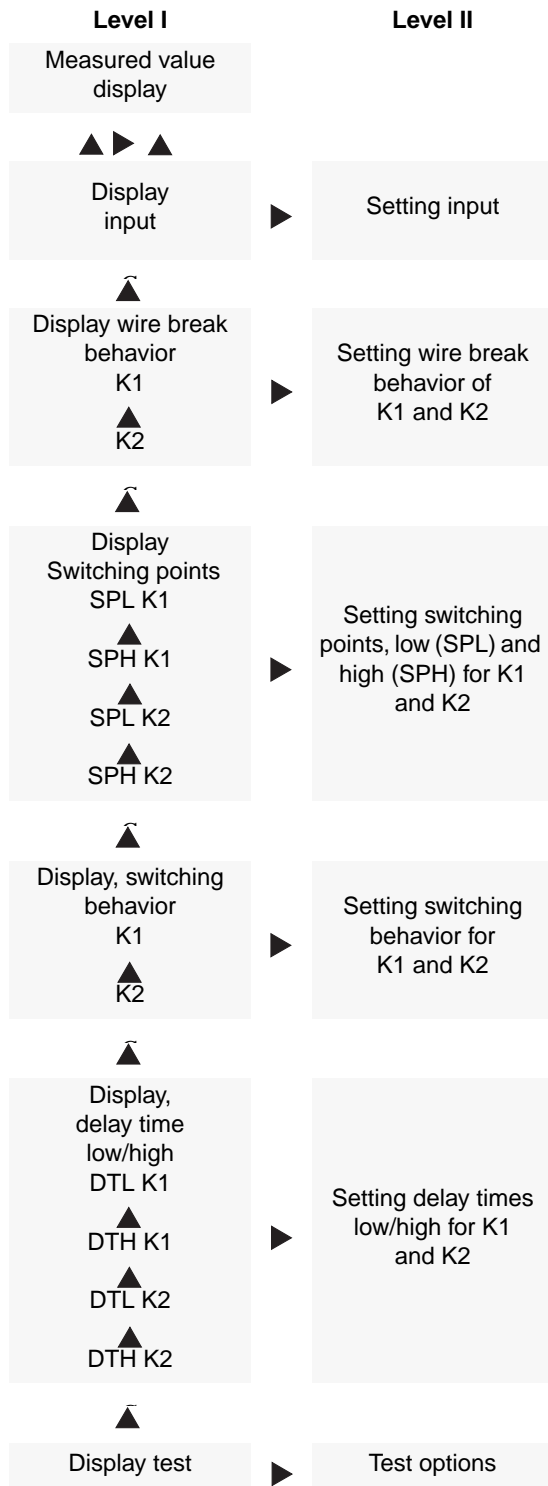

### 6.2. Systematics of operation

The key combination ▲▶▲ switches from measured value display to edit mode, where the input set is then displayed.

**Note:** The three keys must be pressed directly one after another. If there is a break of longer than 2 seconds between pressing two keys, the module returns to measured value display. The time limit is displayed visually by a light running from left to right: if it extinguishes at the fifth digit, the module returns to measured value display.

When you have switched to edit mode, access the desired setting values such as input, wire break behavior, switching points etc. using the ▲ key. On the first vertical level I (see overview), the (pre)set value is displayed. To alter a value, switch to the second vertical level II with the ▶ key. This is signalled on the display by a short illumination of a point in the bottom right-hand corner. When setting the switching points, the decimal point of the point to be altered lights up briefly.

On the second level II, you can browse through the possible settings with the ▲ key. After the final setting, the first setting reappears; it is not possible to browse in reverse order.

If an RTD or TC sensor is set as input, select the desired temperature unit **before** acknowledging with the E key, and in the case of RTD sensors, also select the type of sensor and the size of the resistor.

Only when all the settings have been made on a horizontal level you may press the E key. This ends all the settings on this level and you move to the next position on the vertical level I.

**Attention:** When you have made all the settings, you must exit the edit mode by pressing the ▶ and E keys at the same time. Only then are the values permanently saved.

By pressing the ▲ and ▶ keys at the same time, you can exit the edit mode at any time. The old values are kept and the module returns to operating mode with measured value display.

In the dark hatched bars of the overviews in the following chapters for individual settings, you can see how to return to the particular starting point in each menu. Below this, you are shown how to select the desired settings.



# MCR Threshold Value Switch, Programmable - MCR-PSP

## 6.3. Setting the input

First determine the input signal. If it is an RTD or TC sensor, also select the temperature display unit - °Celsius or °Fahrenheit -, and in the case of RTD sensors, you must also select the type of sensor and the sensor resistance (at 0 °C).

RTD sensors can be wired in 2, 3 or 4-wire circuits (RTD 2, RTD 3 or RTD 4).

### Overview: Setting input

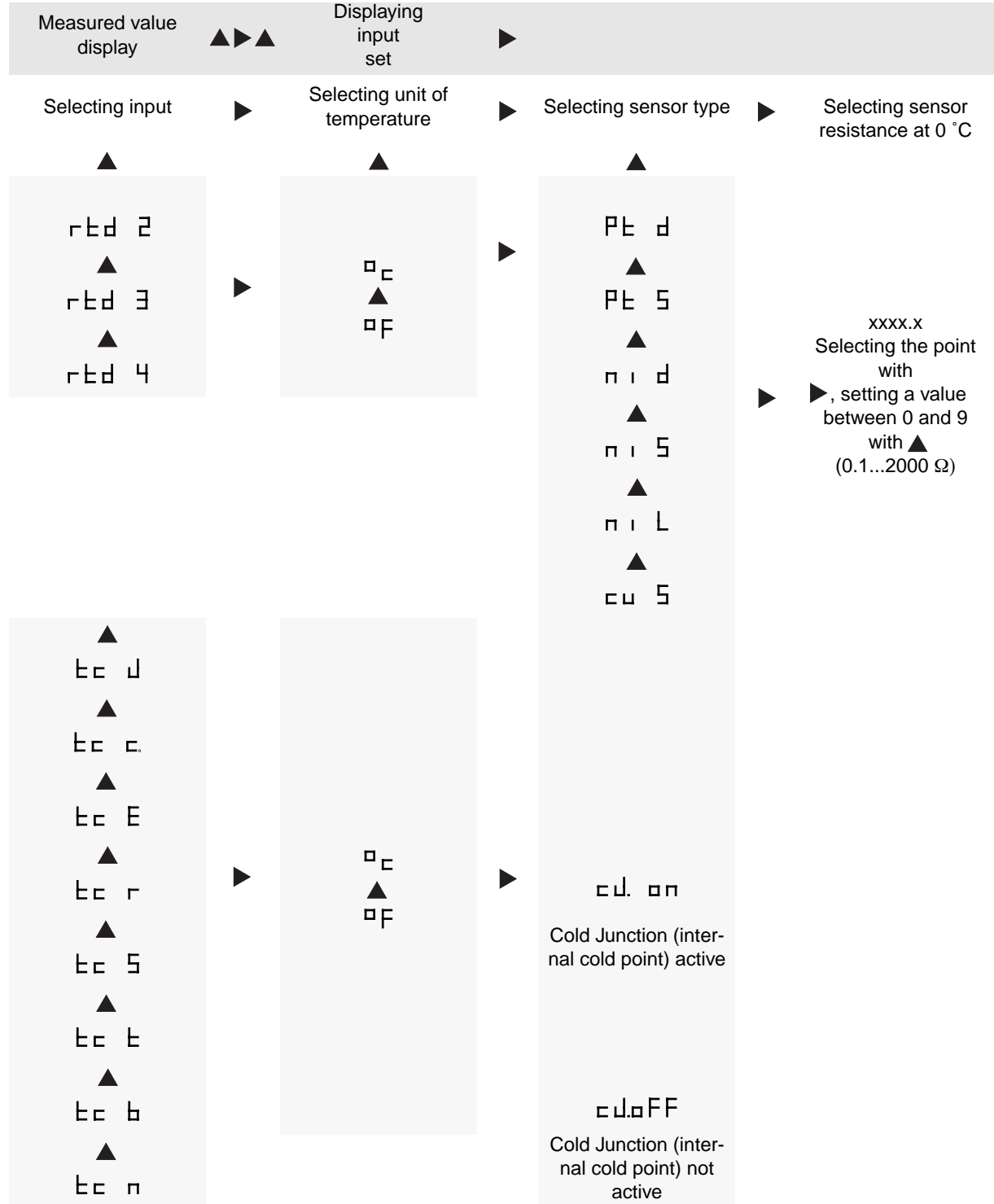

for continuation, see following page (page 10)

# MCR Threshold Value Switch, Programmable - MCR-PSP

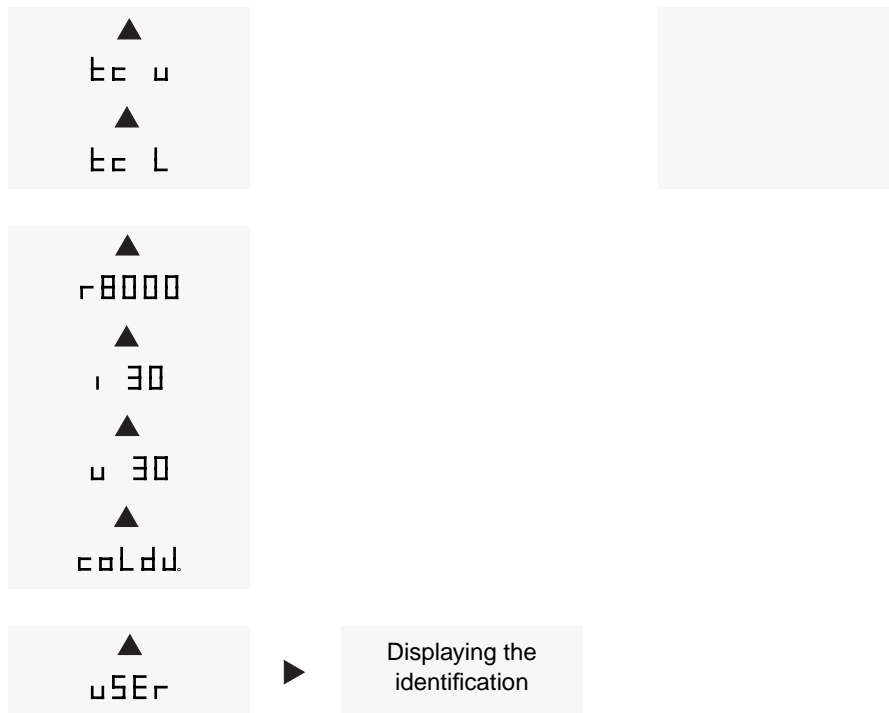

**Example:** You wish to connect a Pt100 sensor in acc. with DIN/IEC in 2-conductor technology with °C as the unit. In this case, set: RTD 2 / °C / Pt d / 0100.0.

## 6.4. Setting wire break behavior

You can set the wire break behavior – pick up or drop out – for each of the two relays. The wire break behavior is independent of the switching behavior set or the set delay times high/low .

### Overview: Setting wire break behavior (Linebreak)

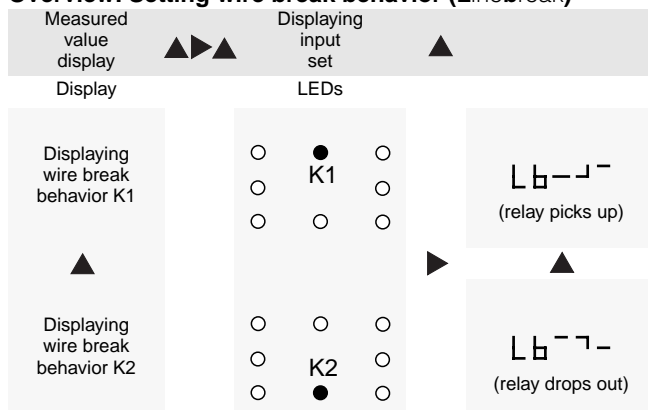

# MCR Threshold Value Switch, Programmable - MCR-PSP

## 6.5. Setting switching points

The switching points determine at which value a relay switches. They may only be set within the measuring range of the input selected. The high switching point, SPH, may not be higher than the maximum permissible value, the low switching point, SPL, must be at least the lowest permissible value. The distance between SPL and SPH must be at least twice the value of the switching tolerance of the input set. The table shows the measuring range and the switching tolerance of the individual inputs.

### Measuring range and switching tolerance of the individual inputs

Input	Measuring range	Switching tolerance
Resistance thermometer (RTD sensors)		
Pt sensors (DIN/SAMA)	-200 to 850 °C -328 to 1562 °F	0.2 K/0.4 °F
Ni sensors (DIN/SAMA)	-60 to 180 °C -76 to 356 °F	
Ni 1000 (Landis & Gyr)	-50 to 160 °C -58 to 320 °F	
Cu 10 (SAMA)	-70 to +500 °C -94 to 932 °F	
Thermocouples (TC sensors)		
TC J	-210 to 1200 °C -346 to 2192 °F	0.5 K/0.9 °F
TC K	-200 to 1372 °C -328 to 2501.6 °F	
TC E	-226 to 1000 °C -374 to 1832 °F	
TC R	-50 to 1768 °C -58 to 3214.4 °F	0.2 K/0.36 °F
TC S		
TC T	-200 to 400 °C -328 to 752 °F	0.5 K/0.9 °F
TC B	500 to 1820 °C 932 to 3308 °F	5.0 K/9.0 °F
TC N	-200 to 1300 °C -328 to 2372 °F	0.5 K/0.9 °F
TC U	-200 to 600 °C -328 to 1112 °F	
TC L	-200 to 900 °C -328 to 1652 °F	
Other inputs		
Resistor (R 8000)	0 to 8 kΩ	1.0 Ω
Voltage (U)	-30 to 30 V	0.01 V
Current (I)	-30 to 30 mA	0.0 1 mA
internal cold point (Cold Junction)	-20 to 70 °C -4 to 158 °F	0.2 K/0.4 °F
User*	0 to 8 kΩ	1.0 Ω

\* Default setting R 8000 (4-conductor system)

### Overview: Setting switching points

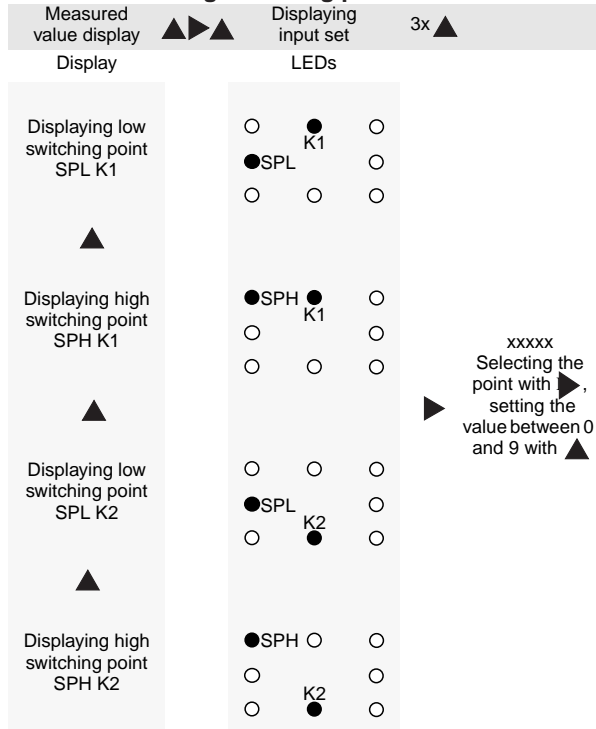

# MCR Threshold Value Switch, Programmable - MCR-PSP

## 6.6. Setting switching behavior

You can define the switching behavior when a given switching point is reached for each relay. The first two options include a hysteresis, i.e. the behavior of the relay depends on the direction from which a switching point is reached.

For the remaining options, with the exception of the last two ("on" and "off"), a switching tolerance is accounted for to prevent the relay contact from "fluttering". The relay is not switched until the switching point plus switching tolerance has been reached.

At "on", the relay is permanently picked up. It only reacts when there is a case of wire break and the setting for such a case for the relay is dropout; for "off", the relay only reacts when there is a case of wire break and the setting for such a case for the relay is picked up. To the right you will find a list of the setting options for the switching behavior and their meaning.

## Setting options for switching behavior

	Relay picks up when SPH is exceeded, hysteresis is active; For course of hysteresis, see fig. 17.
	Relay picks up when value below SPL, hysteresis is active; For course of hysteresis, see fig. 18.
	Relay picks up when value below SPL
	Relay picks up when SPL is exceeded
	Relay picks up when value below SPH
	Relay picks up when SPH is exceeded
	Relay picks up between SPL and SPH
	Relay picks up outside of SPL and SPH
	Relay is permanently dropped out
	Relay is permanently picked up

The points below the symbols indicate SPL and SPH.

## Overview: Setting switching behavior

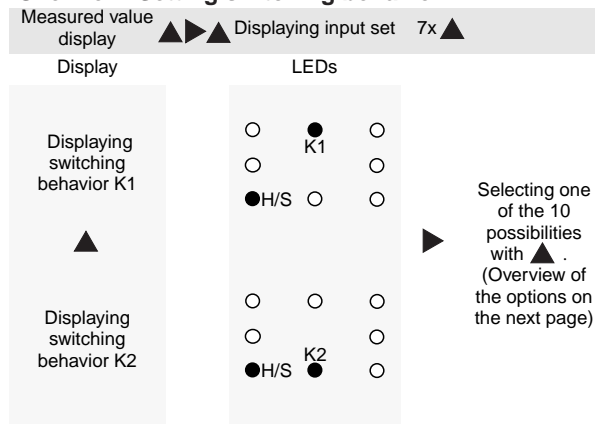

## Course of hysteresis from

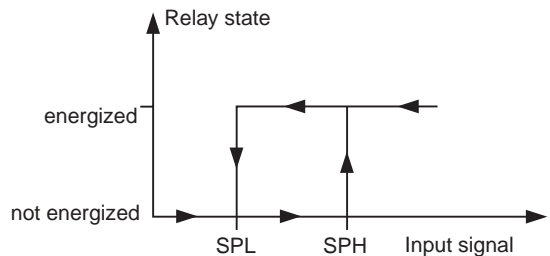

5126A008

Fig. 17

## Course of hysteresis from

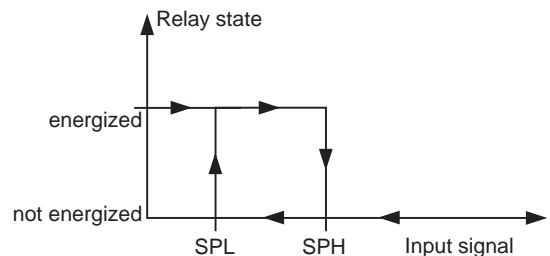

5126A009

Fig. 18

# MCR Threshold Value Switch, Programmable - MCR-PSP

## 6.7. Setting delay times low/high

You can set a delay time high (DTH) and a delay time low (DTL) for each relay. The dropout or pickup time of the relay is then delayed by the given time. You can select the period from values between 0.1 and 2.0 seconds, from 0.1 to 1.0 in steps of one tenth, from 1.0 onward in steps of two tenths.

### Overview: Setting delay times low/high

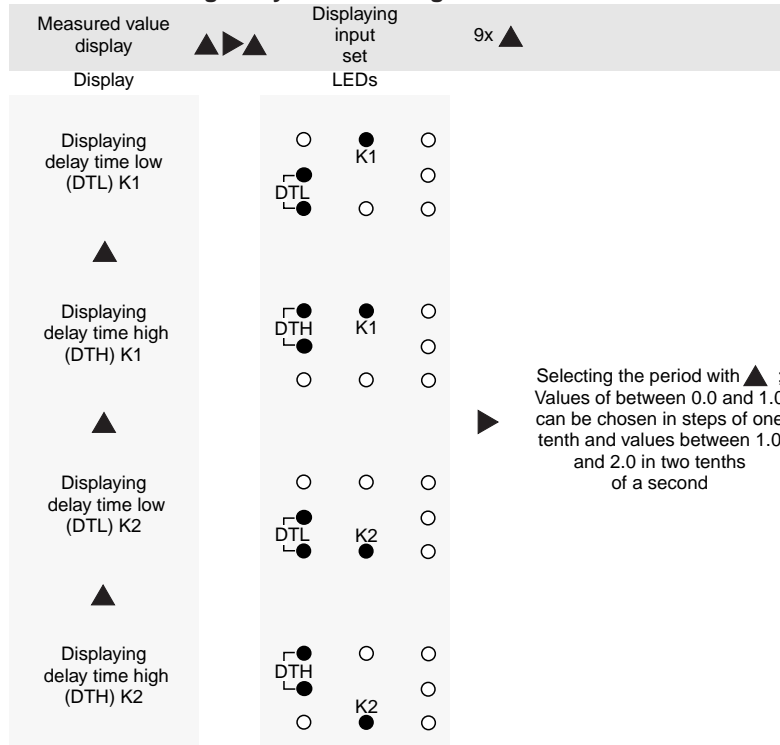

## 6.8. Activating test mode

In test mode, you can test both the LEDs and the outputs. During the LED test, all the segments of the display and all the LEDs are activated one after another. During the outputs test, you can switch each relay on and off as required.

### Overview: Activating test mode

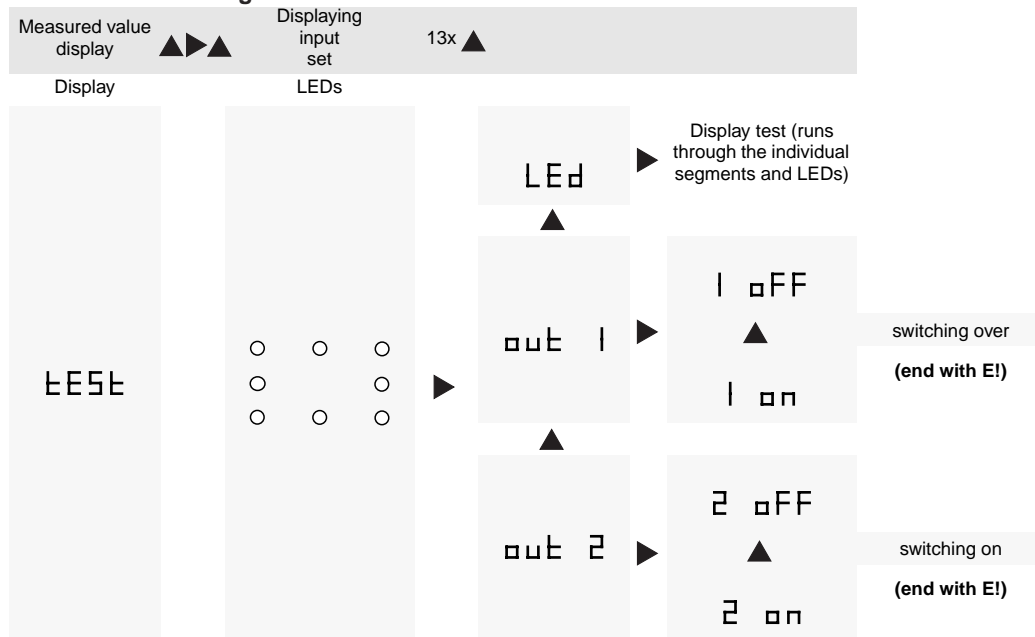

# MCR Threshold Value Switch, Programmable - MCR-PSP

## 7. Error messages

### 7.1. Error messages in operating mode

Error display	Cause	Remedy
E. LB	Wire break	Check wiring/repair
	Input signal too high	Check whether the input signal is within the permissible range (compare table page 5), and if not, alter to permissible range.
E. CJ	Cold junction provides invalid temperature (only in the case of type TC inputs and Cold Junction).	Adjust temperature to valid range.
	Ambient temperature too high or too low	
	Sensor defect (most improbable)	Send device in to be repaired.

### 7.2. Error messages in edit mode

Error display	Cause	Remedy
E.type	Hardware fault	Switch supply on and off. If this is unsuccessful, replace the module.
E.Unit		
E.REL		
E.SPH1	The upper switching point for K1 is higher than the highest permissible value.	The setting is automatically set to the highest permissible value when the E key is pressed again.
E.SPH2	The upper switching point for K2 is higher than the highest permissible value.	
E.SPL1	The lower switching point for K1 is lower than the lowest permissible value.	The setting is automatically set to the lowest permissible value when the E key is pressed again.
E.SPL2	The lower switching point for K2 is lower than the lowest permissible value.	
E.SP1	The lower switching point for K1 plus switching tolerance is higher than the highest switching point.	Reset the switching points. Twice the value of the switching tolerance must lie between SPL and SPH. (compare table page 11/"Setting switching points")
E.SP2	The lower switching point for K2 plus switching tolerance is higher than the highest switching point.	
E.RTD	The sensor resistance has not been set for an RTD sensor or does not lie within the permissible range up to 2000 Ω.	The resistance is set automatically to 2000 Ω after the E key is pressed again.

# MCR Threshold Value Switch, Programmable - MCR-PSP

## 8. Configuration software MCR-CONF-WIN-...

- for
- MCR-T-UI-... temperature transducer
  - MCR-PSP-... threshold value switch

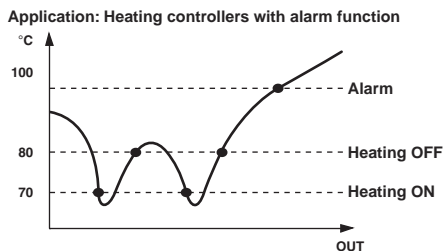

**MCR-CONF-WIN**  
configuration software

### Description

**MCR configuration software**, for programming the MCR-T-... and MCR-PSP-... modules, with 3 1/2" discs, manual, 4 sheets DIN A4 marking labels (112 pieces)

German  
English

**MCR configuration software**, as above, for NT™ computers

German  
English

**DEMO software** for programming under Windows 3.1x, 95, 98 and NT

English  
German

**Software adapter cable** (Stereo jack plug/SUB-D 25-pos.), 1.2 m for programming MCR-T-UI... modules

**Software adapter cable** (6-pos./SUB-D 25-pos.), 1.5 m for programming MCR-PSP modules

**Cable adapter**, flexible, for the transition from 9 to 25-pos. D-SUB plug connector

**Labels**, for marking MCR-T-UI...modules, 4 sheets DIN A4 (112 labels)

### Type

### Order No.

### Pcs. Pkt.

MCR-CONF-WIN	28 14 13 9	1
MCR-CONF-WIN-GB	28 14 32 0	1
MCR-CONF-WIN-NT	28 14 75 5	1
MCR-CONF-WIN-NT-GB	28 14 76 0	1
MCR-CONF-WIN-DEMO-GB	28 14 40 1	1
MCR-CONF-WIN-DEMO	28 14 30 4	1
MCR-TTL/RS232-E	28 14 38 8	1
MCR-TTL/RS232	28 14 39 1	1
PSM-KAD-9SUB25/BS	27 61 29 5	1
MCR-ET 38 X 35 WH	28 14 31 7	1

The MCR configuration software is used to configure and visualize all parameters for the MCR-PSP-... threshold value switch and the MCR-T-UI-... temperature transducer.

The MCR CONF-WIN software runs under Windows 3.1x, Windows 95™ and under Windows 98™.

The new MCR-CONF-WIN-NTsoftware has been specially developed for computers with Windows NT™.

The modules are configured via a serial interface. A label is automatically produced by the software, and can be attached to the module.

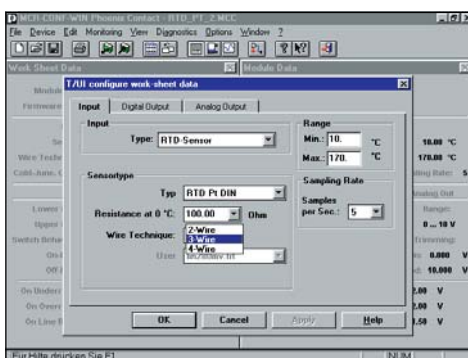

Configuration of the input data of the MCR-T-UI-...-modules

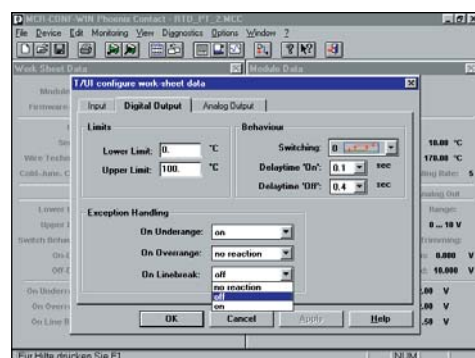

Configuration of the transistor switching output of the MCR-T-UI-...-modules

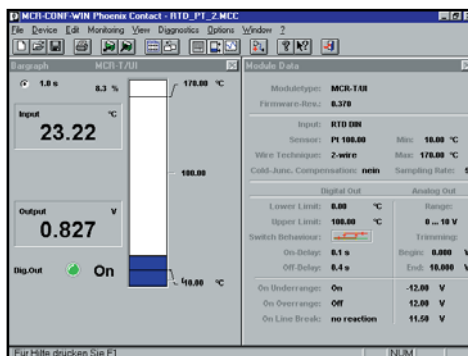

Temperature curve represented in a block diagram

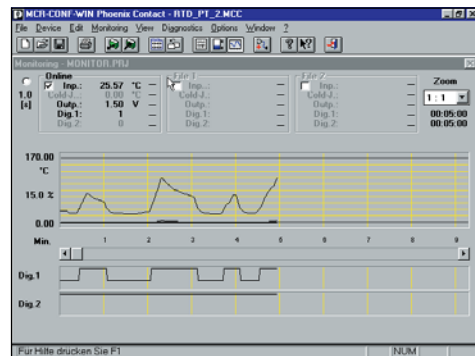

Temperature curve and switching behavior with monitoring function