

# Multi-stage Performance EMI Filter

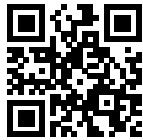

- | Rated currents from 1 to 36 A
- | High differential and common-mode attenuation
- | High frequency attenuation
- | Optional medical versions (B type)
- | Optional safety versions (A type)



### Performance indicators

Attenuation performance



Rated current [A]



### Approvals



### Features and benefits

- | FN 2070 two-stage filters are designed for easy and fast chassis mounting
- | FN 2070 filters are also available as B versions without Y-capacitors for medical applications as well as A version with low capacitance for safety critical applications with necessity for low leakage currents
- | All filters provide a high conducted attenuation performance, based on chokes with high saturation resistance and excellent thermal behavior
- | FN 2070 two-stage filters are designed for high frequency attenuation
- | FN 2070 filters are also available as single-stage filters (FN 2020 series)
- | Various terminal options allow you to select the desired connection style

### Technical specifications

<b>Operating voltage</b>	110/250 VAC, 50/60 Hz
<b>Operating frequency</b>	dc to 400 Hz
<b>Rated currents</b>	1 to 36 A @ 40 °C max.
<b>High potential test voltage</b>	P → PE 2000 VAC for 2 sec P → N 1100 VDC for 2 sec P → PE 2500 VAC for 2 sec (B types)
<b>Temperature range (operation and storage)</b>	-25 °C to +100 °C (25/100/21)
<b>Flammability corresponding to</b>	UL 94 V-2 or better
<b>Design corresponding to</b>	UL 1283, CSA 22.2 No. 8 1986, IEC/EN 60939
<b>MTBF @ 40°C/230V (Mil-HB-217F)</b>	1,550,000 hours 1,600,000 hours (B types)



### Typical applications

- | Electrical and electronic equipment
- | Consumer goods
- | Household equipment
- | Building automation
- | Industrial applications
- | Machinery
- | Medical equipment
- | Electronic data processing equipment
- | Office automation and datacom equipment
- | Various noisy applications requiring good filter performance

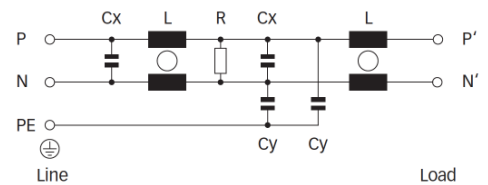
### Typical electrical schematic



### Filter selection table

Filter*	Rated current @ 40 °C (25 °C)	Leakage current** @ 230 VAC/50 Hz	Inductance L	Capacitance Cx Cy		Resistance R	Input/Output connections			Weight
	[A]	[mA]	[mH]	[μF]	[nF]	[kΩ]				[g]
FN 2070-1-..	1 (1.2)	0.734	22	0.33	4.7	1000	-06	-07		190
FN 2070-3-..	3 (3.5)	0.734	9.8	0.47	4.7	470	-06	-07		250
FN 2070-6-..	6 (6.9)	0.734	7.8	1	4.7	220	-06	-07		450
FN 2070-10-..	10 (11.5)	0.734	4.5	1	4.7	220	-06	-07		670
FN 2070-12-..	12 (13.8)	0.734	3.25	1	4.7	220	-06	-07		670
FN 2070-16-..	16 (18.4)	0.734	2.8	1	4.7	220	-06	-07	-08	1000
FN 2070-25-08	25 (28.8)	0.734	2	2.2	4.7	220			-08	760
FN 2070-36-08	36 (41.4)	0.867	1.23	2.2	4.7	220			-08	790
FN 2070A-1-..	1 (1.2)	0.074	22	0.33	0.47	1000	-06	-07		190
FN 2070A-3-..	3 (3.5)	0.074	9.8	0.47	0.47	470	-06	-07		250
FN 2070A-6-..	6 (6.9)	0.074	7.8	1	0.47	220	-06	-07		450
FN 2070A-10-..	10 (11.5)	0.074	4.5	1	0.47	220	-06	-07		670
FN 2070A-12-..	12 (13.8)	0.074	3.25	1	0.47	220	-06	-07		670
FN 2070A-16-..	16 (18.4)	0.074	2.8	1	0.47	220	-06	-07	-08	1000
FN 2070A-25-08	25 (28.8)	0.074	2	2.2	0.47	220			-08	760
FN 2070A-36-08	36 (41.4)	0.074	1.23	2.2	0.47	220			-08	790
FN 2070B-1-..	1 (1.2)	0.002	22	0.33		1000	-06	-07		190
FN 2070B-3-..	3 (3.5)	0.002	9.8	0.47		470	-06	-07		250
FN 2070B-6-..	6 (6.9)	0.002	7.8	1		220	-06	-07		450
FN 2070B-10-..	10 (11.5)	0.002	4.5	1		220	-06	-07		670
FN 2070B-12-..	12 (13.8)	0.002	3.25	1		220	-06	-07		670
FN 2070B-16-..	16 (18.4)	0.002	2.8	1		220	-06	-07	-08	1000
FN 2070B-25-08	25 (28.8)	0.002	2	2.2		220			-08	760
FN 2070B-36-08	36 (41.4)	0.002	1.23	2.2		220			-08	790

\* To compile a complete part number, please replace the .. with the required I/O connection style (e.g. FN 2070-25-08, FN 2070B-10-06).  
 \*\* Maximum leakage under normal operating conditions. Note: if the neutral line is interrupted, worst case leakage could reach twice this level.

### Typical filter attenuation

Per CISPR 17; A = 50 Ω/50 Ω sym; B = 50 Ω/50 Ω asym; C = 0.1 Ω/100 Ω sym; D = 100 Ω/0.1 Ω sym

1 A types

3 to 12 A types

16 A types

25 and 36 A types

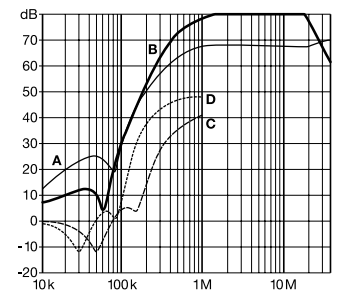
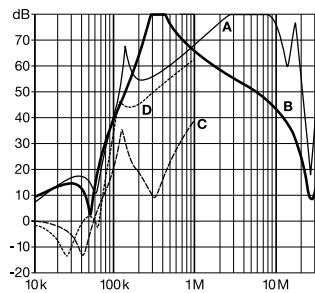
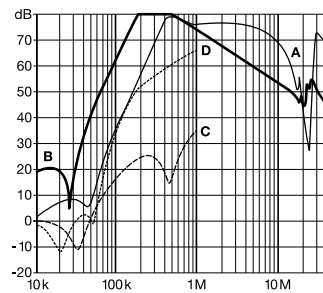
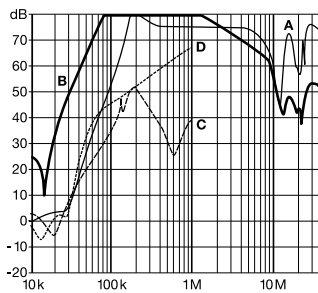

**Mechanical data**

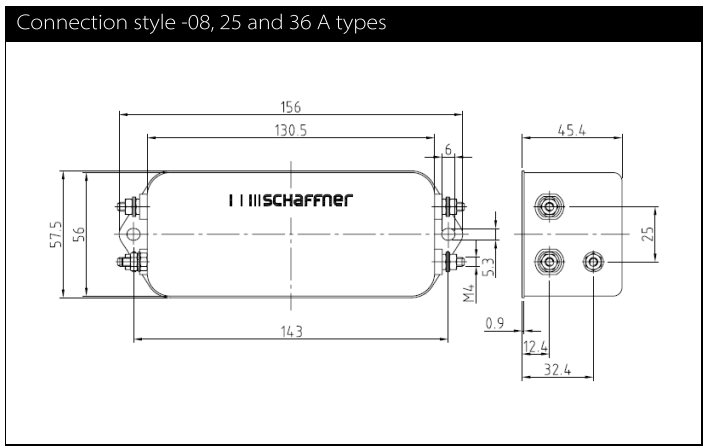
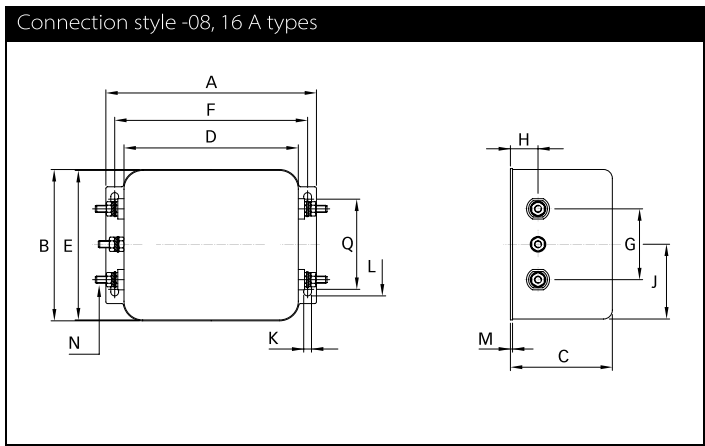
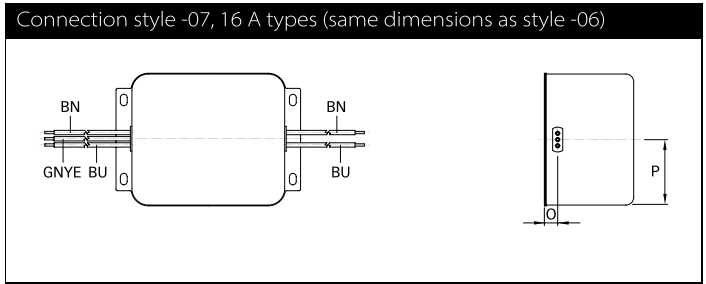
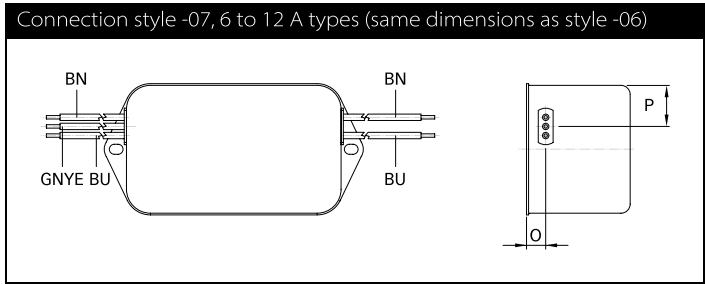
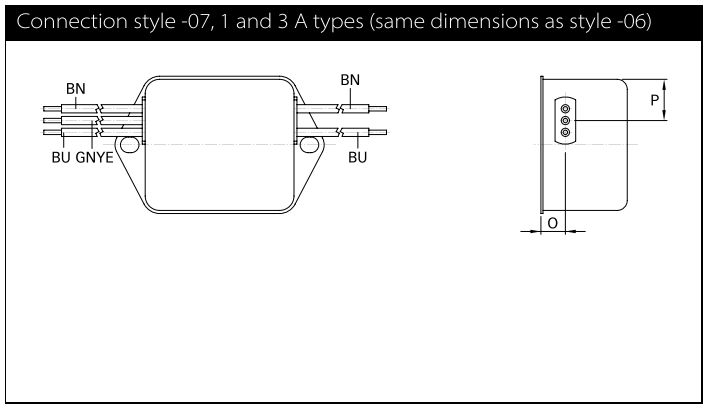
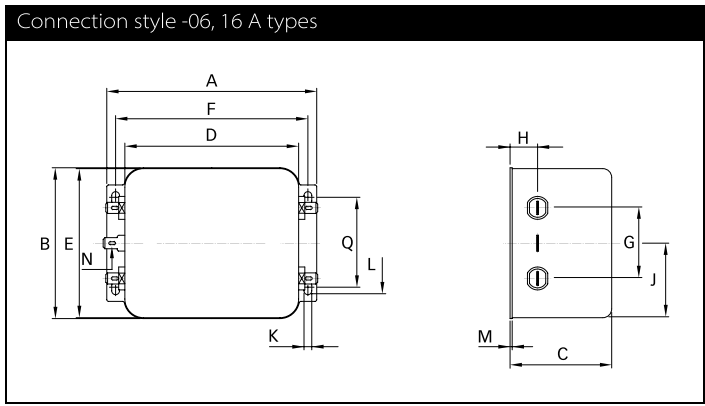
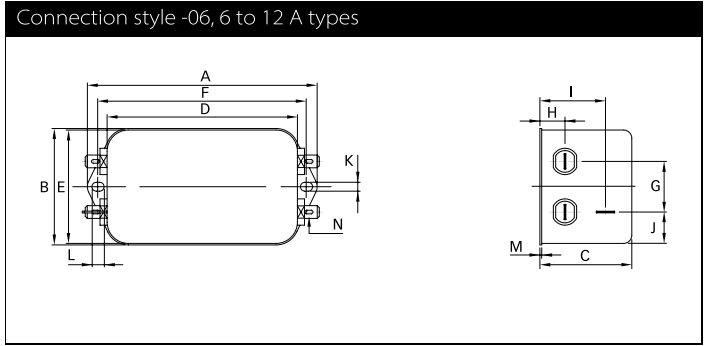
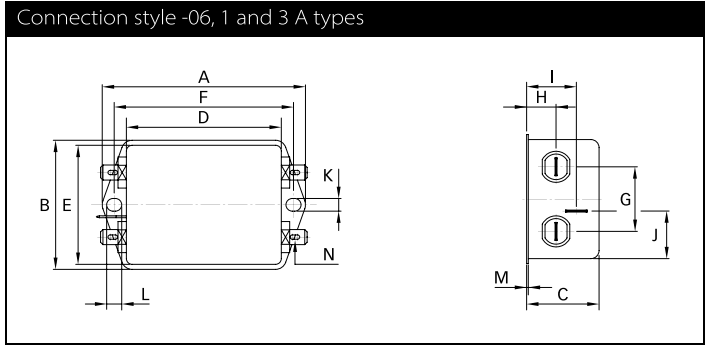

## Dimensions

	1 A	3 A	6 A	10 A	12 A	16 A	25 A	36 A	Tolerances
<b>A</b>	85 ±0.5	85 ±0.5	113.5	156	156	119	156	156	±1
<b>B</b>	54 ±0.5	54 ±0.5	57.5	57.5	57.5	85.5	57.5	57.5	±1
<b>C</b>	30.3 ±0.5	40.3 ±0.5	45.4	45.4	45.4	57.6	45.4	45.4	±1
<b>D</b>	64.8 ±0.5	64.8 ±0.5	94	130.5	130.5	98.5	130.5	130.5	±1
<b>E</b>	49.8	49.8	56	56	56	84.5	56	56	±0.5
<b>F</b>	75	75	103	143	143	109	143	143	±0.3
<b>G</b>	27	27	25	25	25	40	25	25	±0.2
<b>H</b>	12.3	12.3	12.4	12.4	12.4	15.6	12.4	12.4	±0.5
<b>I</b>	20.8	29.8	32.4	32.5	32.5		32.5	32.5	±0.5
<b>J</b>	19.9	11.4	15.5	15.5	15.5	42.25	15.5	15.5	±0.5
<b>K</b>	5.3	5.3	4.4	5.3	5.3	4.4	5.3	5.3	
<b>L</b>	6.3	6.3	6	6	6	7.4	6	6	
<b>M</b>	0.7	0.7	0.9	1	1	1.2	1	1	
<b>Connection style -06</b>									
<b>N</b>	6.3 x 0.8	6.3 x 0.8	6.3 x 0.8	6.3 x 0.8	6.3 x 0.8	6.3 x 0.8			
<b>Connection style -07</b>									
<b>O</b>	8.3	8.3	8.4	8.4	8.4	8.6			±0.5
<b>P</b>	14.9	14.9	18	18	18	42.25			±0.5
<b>AWG type wire</b>	AWG 20	AWG 20	AWG 18	AWG 18	AWG 16	AWG 16			
<b>Wire length</b>	140	140	140	140	140	140			+5
<b>Connection style -08</b>									
<b>N</b>						M4	M4	M4	
<b>Q</b>						51			±0.2

All dimensions in mm; 1 inch = 25.4 mm  
Tolerances according: ISO 2768-m / EN 22768-m

Please visit [www.schaffner.com](http://www.schaffner.com) to find more details on filter connectors.